



OFFICIAL BUDGET

FISCAL YEAR
2022-2023

COBB COUNTY SCHOOL DISTRICT
MARIETTA, GEORGIA
www.cobbk12.org



EXECUTIVE SUMMARY SECTION

Letter of Transmittal 8
Association of School Business Officials International – Meritorious Budget Award..... 10
EXECUTIVE SUMMARY MESSAGE
Board Members and Superintendent..... 12
School District Organizational Chart..... 13
District Core Vision, Beliefs, and Goals..... 14
FY2023 Board of Education Adopted Budget 15
Highlights of FY2023 Budget 16
Federal ESSER Funding for COVID 19 20
Challenges Faced by The District – State Revenue..... 22
Challenges Faced by The District – Local Revenue..... 25
Budget Assumption/Initiatives and Constraints 29
Legislative Priorities 32
Community Demographic and Financial Information..... 34
Budget Development Timeline and Calendar 37
Personnel Resource Changes – General Fund..... 38
Personnel Resource Changes – Other Funds..... 42
General Fund Forecast 43
Other Funds Forecast..... 44
Capital Project Fund Forecast 45
Cobb County Certified 2022 School Digest..... 46
Current 2022 Tax Digest and 5 Year History of Levy..... 47
Millage Rate Trends 48

ORGANIZATIONAL SECTION

Board Function and Composition..... 50
Board Elected Officials and Superintendent 51
School Board Post Areas..... 52
School District Organizational Chart..... 53
School District Entity..... 54
About the School District..... 56
MISSION & GOAL
District Mission Statement..... 58
District Core Value, Beliefs, and Goals..... 59
District Direction for Continuous Improvement 60
PAY FOR PRIORITIES
Ratio of Pupils to Professional Personnel 62
Cost per Pupil Enrolled..... 63
Comparison of State and Cobb Teacher Salaries 64
Improvement Opportunities in the Budget Planning Process..... 65
POLICY, PROCEDURE, & PROCESS
Fiscal Management Goals and Objectives 67
Planning, Programming, Budgeting System 68
Local Tax Revenues 71
Accounting and Reporting 73
Grants..... 80
Audits 83
Fraud Prevention 84

Student Activities Funds Management	85
Public Information Program.....	86
Partners in Education.....	87
Authorization of Enhanced Security.....	89
Budget Development Process.....	91
Budget Development Timeline and Calendar	93
Budget Amendment Procedures	94
Capital Budget Development Process.....	97
Capital Projects Approval and Budget Adjustment Guidelines	98
<u>DIVISION AND DEPARTMENTAL INFORMATION</u>	
Superintendent Division.....	100
Chief of Staff Division.....	102
Operational Support Division.....	108
Technology Services Division.....	115
Human Resources Division.....	118
Strategy & Accountability Division	124
Academic Division	135
School Leadership Division	154
Financial Services Division.....	156
Key Principles Guide Budget Development	163
District Policy on Fund Balance and Reserve	165
Fund Description and Basis of Accounting.....	167
Other Sustaining Local Revenue Sources.....	169
Relationship of Organizational Units by Function and Expenditure Object Code.....	170
FINANCIAL SECTION	
FY2023 Consolidated Budget Statement.....	175
All Funds Combined Budget Summary – Eight Years Summary	176
Revenue/Expenditure for All Funds – Graph.....	177
General Fund Forecast.....	178
Other Funds Forecast.....	179
Capital Project Fund Forecast	180
<u>IMPLEMENT FINANCIAL PLAN</u>	
<u>GENERAL FUND BUDGET</u>	
General Fund Revenues and Appropriations by Function	183
General Fund Revenues and Appropriations by Object.....	184
Five Year Trend of Fund Balance	185
Fiscal Year 2023 Revenue Explanations and Projections.....	186
Major Categories of General Fund Budget	192
Fiscal Year 2023 General Fund Revenue – Graph	195
Fiscal Year 2023 General Fund Expenditures – Graph	196
Bond Debt & Long-Term Obligation.....	197
<u>SPECIAL REVENUE FUND BUDGET</u>	
Special Revenue Fund Revenues and Appropriations by Function.....	201
Special Revenue Fund Revenues and Appropriations by Object	202
Five Year Trend of Fund Balance	203
Special Revenue Fund Descriptions	204
American Rescue Plan (ARP) Act.....	206
Summary of Special Revenue Funds.....	207

DEBT SERVICE FUND BUDGET

Debt Service Fund by Function 214
Debt Service Fund by Object..... 215
Five Year Trend of Fund Balance..... 216
Bond Debt Issues 217

CAPITAL PROJECTS FUND BUDGET

Capital Projects Fund Revenues and Appropriations by Function 220
Capital Projects Fund Revenues and Appropriations by Object..... 221
Five Year Trend of Fund Balance..... 222
Capital Projects Description 223
Summary of Capital Projects Fund..... 228
About SPLOST 229
SPLOST 4 Projects 231
SPLOST 4 Revenues – Graph 232
SPLOST 4 Expenditures – Graph..... 233
SPLOST 5 Projects 234
SPLOST 5 Revenues – Graph 235
SPLOST 5 Expenditures – Graph..... 236
District Building Fund 237

INTERNAL SERVICE AND OTHER SERVICE FUND BUDGET

Internal Service and Other Service Funds Revenue and Appropriations by Function 239
Internal Service and Other Service Funds Revenue and Appropriations by Object 240
Five Year Trend of Fund Balance..... 241
Internal Service and Other Service Fund Descriptions..... 242
Summary of Internal Service and Other Service Funds..... 243

INFORMATIONAL SECTION

Millage Rate and Property Tax Calculation..... 245
Tax Rate Effect on the Average Taxpayer..... 247
District Student Enrollment 248
Personnel Resources 249
General Fund Forecast..... 252

DISTRICT & STUDENT PERFORMANCE

Cobb Commitment..... 254
Georgia Names 16 Cobb High Schools 2022 AP Honor Schools 255
Cobb Schools Celebrate Graduations for 8000 Students 257
Cobb High Schools Continue to Rank Among the Best 259
Cobb Schools Wins Human Resources Awards 261
Communications Team Wins International Awards..... 262
Georgia Milestones Tests Scores 264
Scholastic Assessment Test (SAT) Scores 269
American College Testing (ACT) Scores..... 271
Four-Year Graduation Rate 273
Expenditures Per FTE..... 277

INFORMATIONAL & STATISTICAL DATA

Net Position by Component.....	280
Changes in Net Position – Last 10 Fiscal Years	282
Fund Balance, Governmental Funds – Last 10 Years.....	284
Changes in Fund Balance, Governmental Funds – Last 10 Fiscal Years	286
Property Tax Levies and Collections.....	288
Assessed & Estimated Actual Value of Taxable Property – Last 10 Fiscal Years	289
Direct and Overlapping Property Tax Rates – Last 10 Fiscal Years	290
Principal Property Taxpayers – December 31, 2021 and Nine Years Ago.....	291
Legal Debt Margin Information – Last 10 Fiscal Years	292
Legal Debt Margin Information – Fiscal Year 2022	293
Ratios of Outstanding Debt by Type – Last 10 Fiscal Years.....	294
Ratio of Net General Bonded Debt to Estimated Actual Value & Net Bonded Debt per Capita- Last 10 Fiscal Years	295
Computation of Direct and Overlapping General Obligation Debt	296
Cobb County Demographic and Economic Statistics – Last 10 Calendar Years	297
Principal Employers – Current Year and Nine Years Ago	298
Comparison of Metropolitan Atlanta School District Property Tax Rates	299
Cobb County Bank Deposits, Construction & Taxable Property Values – Last 10 Years	300
Property Digest Reductions due to Exemptions – Last 10 Fiscal Years.....	301
Number of Personnel & Ratio of Pupils to Professional Personnel – Last 10 Fiscal Years.....	302
Operating Statistics – Last 10 Fiscal Years	303
General Fund Expenditures by Function – Last 10 Fiscal Years.....	304
General Fund Revenues by Source – Last 10 Fiscal Years	305
Ratio of Annual Debt Service Expenditures for General Bonded Debt to Total General Expenditures – Last 10 Fiscal Years.....	306
Results of All Bond and Sales Tax Referendums – 1950 to Present	307
School Buildings – Last 10 Fiscal Years	308
Teacher’s Salary Schedule – Last 10 Fiscal Years	316
Administrative Salary Schedule.....	317
Schedule of Insurance in Force.....	318
School Lunch & Breakfast Program – Last 10 Fiscal Years	320
Number of Schools – Last 10 Fiscal Years.....	321
Number of High School Graduates and Average Daily Enrollment & Attendance – Last 10 Fiscal Years.....	322
Active Enrollment by Grade Level – Last 10 Fiscal Years	323
Classroom Buildings, Grade Levels and Acreage	324
<u>GLOSSARY</u>	
Glossary of Terms.....	327

Executive Summary

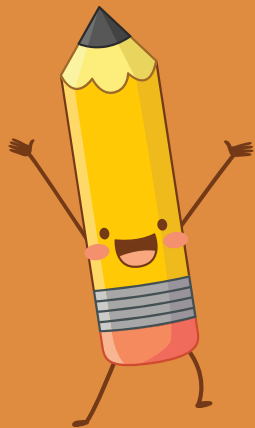

May 19, 2022

Members of the Cobb County Board of Education
Citizens of Cobb County, Georgia

We are pleased to present to you the Cobb County School District Budget for FY2023.

The FY2023 General Fund Budget is structurally balanced as revenues of \$1,303,409,442 plus utilization of \$29,851,087 in fund balance reserve is equal to recurring expenditures. The expenditure budget is \$1,333,260,529. The budget is based on a predicted enrollment of 106,732 (including Devereux, PreK and MOWR) students and major highlights include:

- \$23 Million State of Georgia QBE Austerity Cut Restoration
- General Fund Millage Rate 18.90 Mills – No Millage Increase (LT Debt Free since 2007)
- Aaa and MIG1 – Highest Moody’s Investors Service Long-Term and Short-Term Credit Rating
- AAA and A-1 – Highest Standard & Poor’s Long-Term and Short-Term Credit Rating
- AAA and K1+ – Highest Kroll Bond Rating Agency’s Long-Term and Short-Term Credit Rating
- Local Revenue Property Value Digest Growth – 10.49%
- 107.30 Instructional Support Positions
- 10.00 School Psychologists
- 5.00 Custodian Positions (Based on square footage)
- (226.50) Position adjustments to accommodate the decrease in students due to the pandemic – Teachers to be added incrementally as students return
- Budgeted Fund Balance Usage – (\$29,851,087)
- Salary Step Increase for All Eligible Employees
- Salary Increase for All Non-Temporary Employees – (Salary increase range 8.5% - 13.1% depending upon step eligibility)

The preparation of this budget has required input from all levels of the organization on how to best educate our students. Cobb County Schools are among the strongest in the state and the nation in academic performance. Our students consistently outperform their peers on standardized tests at both the state and national level. Our budget focuses on optimizing student academic achievement with available resources and reflects the priorities of our District and the community.

The Cobb County School District has two types of employees: those who teach and those who serve those who teach. Our dedicated staff members have proven their commitment to the success of our students and schools. We have a tremendous Team in this District and every Team member has gone above and beyond all year. Once again, I am recommending a budget which prioritizes our staff in a significant and well-deserved way. To all the teachers who make Cobb home, this proposed budget is another reason why Cobb is the best place to teach, lead, and learn. We work together as **One Team** with **One Goal** to achieve **Student Success**.



We look forward to your discussion and support of the FY2023 Budget.

Respectfully submitted,

A handwritten signature in blue ink, appearing to read "Chris Ragsdale", is displayed on a light blue rectangular background.

Chris Ragsdale
Superintendent

A handwritten signature in blue ink, appearing to read "Bradley Reuben Johnson", is displayed on a light blue rectangular background.

Bradley Reuben Johnson
Chief Financial Officer





ASSOCIATION OF
SCHOOL BUSINESS OFFICIALS
INTERNATIONAL

This Meritorious Budget Award is presented to

COBB COUNTY SCHOOL DISTRICT

for excellence in the preparation and issuance of its budget
for the Fiscal Year 2021-2022.

The budget adheres to the principles and standards
of ASBO International's Meritorious Budget Award criteria.



A handwritten signature in black ink, reading 'William A. Sutter'.

William A. Sutter
President

A handwritten signature in black ink, reading 'David J. Lewis'.

David J. Lewis
Executive Director

Executive Summary Message



**COBB COUNTY SCHOOL DISTRICT
ELECTED OFFICIALS AND SUPERINTENDENT OF SCHOOLS
JUNE 30, 2022**



**RANDY
SCAMIHORN**

POST 1

10 Years Served



**DR. JAHA
HOWARD**

POST 2

4 Years Served



**LEROY TRE'
HUTCHINS**

POST 3

2 Years Served



**DAVID
CHASTAIN**

POST 4

8 Years Served

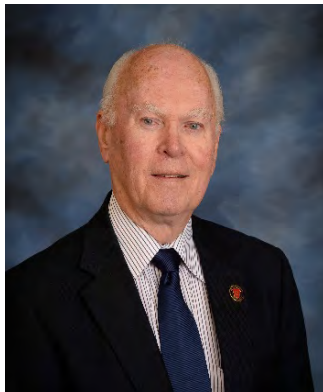

DAVID BANKS

POST 5

14 Years Served



CHARISSE DAVIS

POST 6

4 Years Served



BRAD WHEELER

POST 7

10 Years Served



CHRIS RAGSDALE

SUPERINTENDENT

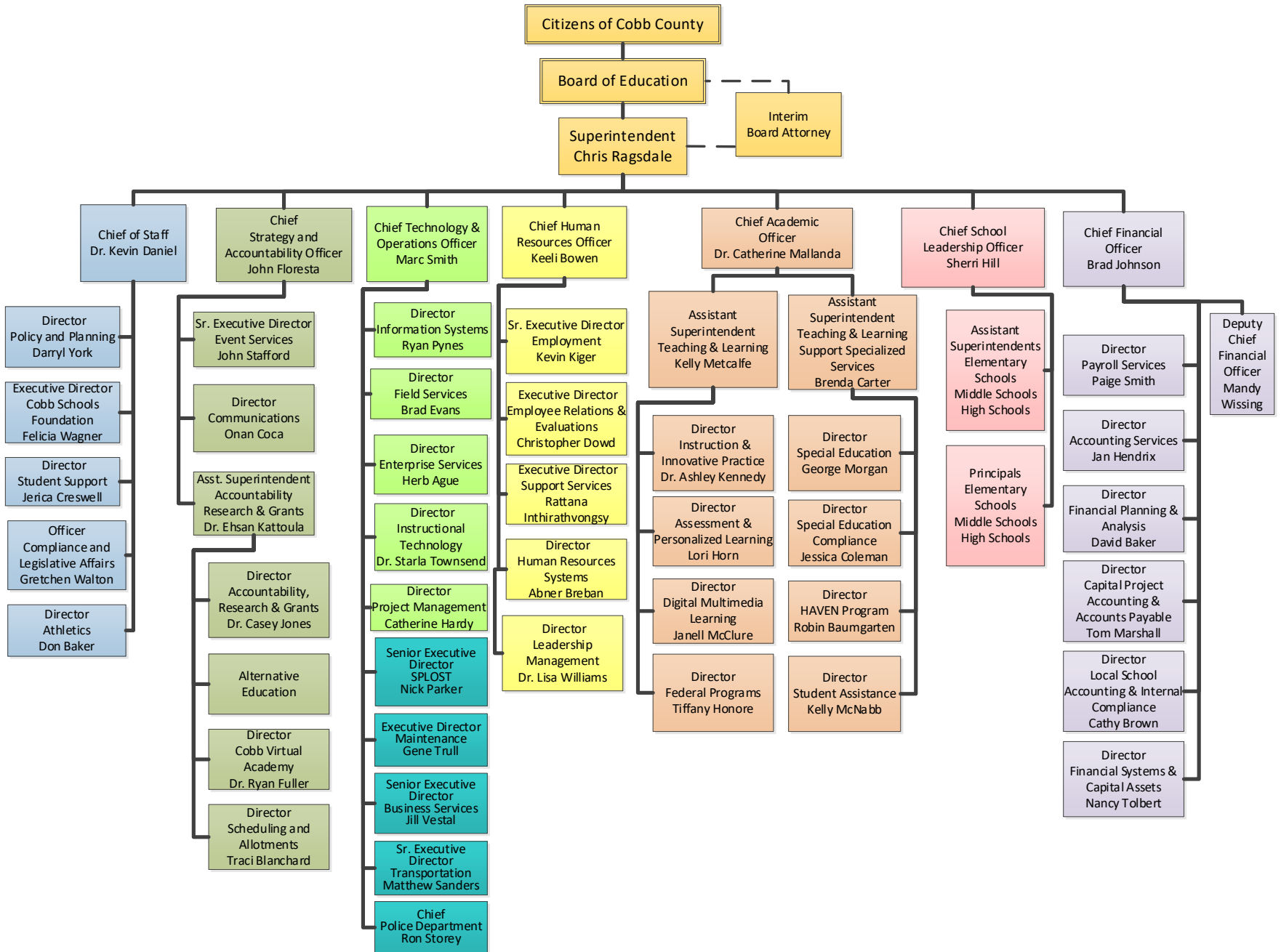

**EXECUTIVE SUMMARY
DISTRICT CORE VALUES, BELIEFS AND GOALS**

Our Core Values, Beliefs, and Goals

Our Core Values

Achievement - aspiring to the highest level of excellence

Integrity - demonstrating honesty, consistency, taking responsibility for action, being worthy of trust

Creativity/Innovation - supporting flexibility, adaptability in keeping up with changes in education and technology

Accountability - taking responsibility for actions, outcomes, and expectations

Our Beliefs

We believe successful schools are a foundation of community stability, growth, and prosperity.

We believe family and community engagement is critical to student and district success.

We believe in a constant and purposeful focus on what is best for students.

We believe creativity and innovation are encouraged and embraced by all stakeholders.

We believe in cultivating a positive environment where students are provided pathways for success.

Our Goals

Vary learning experiences to increase success in career paths.

Differentiate resources for areas/schools based on needs.

Develop stakeholder involvement to promote student success.

Recruit, hire, support, and retain employees for the highest levels of excellence.

COBB COUNTY SCHOOL DISTRICT
FY2023 BOARD OF EDUCATION APPROVED BUDGET

	<u>GENERAL FUND</u>	<u>SPECIAL REVENUE</u>	<u>DEBT SERVICE</u>	<u>CAPITAL PROJECTS</u>	<u>INTERNAL SERVICES</u>	<u>TOTAL ALL FUNDS</u>
Revenues:						
Local Revenue	\$710,189,797	\$35,395,025	\$0	\$3,000	\$6,474,765	\$752,062,587
State Revenue	\$584,111,998	\$5,792,766	\$0	\$1,735,287	\$0	\$591,640,051
Federal Revenue	\$8,692,647	\$88,560,626	\$0	\$0	\$0	\$97,253,273
Transfer Revenue	\$415,000	\$1,770,200	\$0	\$1,000,000	\$0	\$3,185,200
Total Revenue	<u>\$1,303,409,442</u>	<u>\$131,518,617</u>	<u>\$0</u>	<u>\$2,738,287</u>	<u>\$6,474,765</u>	<u>\$1,444,141,111</u>
Utilize Fund Balance	\$29,851,087	\$4,514,167	\$0	(\$988,287)	\$0	\$33,376,967
Total Resources	<u>\$1,333,260,529</u>	<u>\$136,032,784</u>	<u>\$0</u>	<u>\$1,750,000</u>	<u>\$6,474,765</u>	<u>\$1,477,518,078</u>
Appropriations:						
Instruction	\$965,877,709	\$28,481,178	\$0	\$0	\$0	\$994,358,887
Pupil Support Services	\$32,915,803	\$5,594,463	\$0	\$0	\$0	\$38,510,266
Improvement of Instructional Services	\$29,702,800	\$9,165,005	\$0	\$0	\$0	\$38,867,805
Educational Media Services	\$21,720,665	\$7,748	\$0	\$0	\$0	\$21,728,413
Instructional Staff Training	\$0	\$11,783,290	\$0	\$0	\$0	\$11,783,290
Federal Grant Administration	\$0	\$993,138	\$0	\$0	\$0	\$993,138
General Administration	\$13,805,073	\$1,825,980	\$0	\$0	\$0	\$15,631,053
School Administration	\$80,555,744	\$24,545	\$0	\$0	\$0	\$80,580,289
Support Services - Business	\$11,014,358	\$28,173	\$0	\$0	\$6,450,765	\$17,493,296
Maintenance and Operation of Plant Services	\$83,862,800	\$2,009,027	\$0	\$0	\$0	\$85,871,827
Student Transportation	\$64,112,380	\$1,746,936	\$0	\$0	\$0	\$65,859,316
Central Support Services	\$25,848,109	\$163,749	\$0	\$0	\$0	\$26,011,858
Other Support Services	\$654,540	\$20,693	\$0	\$0	\$0	\$675,233
School Nutrition	\$0	\$63,042,378	\$0	\$0	\$0	\$63,042,378
Enterprise Operations	\$0	\$0	\$0	\$0	\$24,000	\$24,000
Community Services	\$420,348	\$11,146,581	\$0	\$0	\$0	\$11,566,929
Capital Outlay	\$0	\$0	\$0	\$1,750,000	\$0	\$5,913,914
Other Outlays	\$2,770,200	\$0	\$0	\$0	\$0	\$2,770,200
Debt Service	\$0	\$0	\$0	\$0	\$0	\$0
Total Appropriations	<u>\$1,333,260,529</u>	<u>\$136,032,784</u>	<u>\$0</u>	<u>\$1,750,000</u>	<u>\$6,474,765</u>	<u>\$1,477,518,078</u>

EXECUTIVE SUMMARY HIGHLIGHTS OF FY2023 BUDGET

Cobb Board of Education Approved Fiscal Year 2023 Budget

On May 19, 2022 the Cobb County Board of Education approved a \$1.47 billion budget. This amount includes both General Funds and other funds for Fiscal Year 2023. The budget includes a 180-day school year. Our fiscal year begins July 1, 2022 and runs through June 30, 2023.

The FY2023 General Fund Budget includes \$1,303,409,442 in revenue plus the utilization of \$29,851,087 in fund balance reserve. Our recurring expenditures are \$1,333,260,529.

The budget is based on a predicted enrollment of approximately 106,732 students (including PreK, Devereux, and MOWR). It reflects years of responsible financial management, judicious planning, and some of the lowest central administrative costs in the State. In our FY2023 General Fund Budget, all eligible employees receive a full Salary Step increase. All non-temporary employees will receive a salary increase of 8.5% to 13.1%, depending on step eligibility.

The District's carefully implemented budget research, along with prudent financial management, keeps the District in a sound financial position. The Cobb County School District has remained debt free since the last principal and interest payment was made on January 31, 2007.

The Development of Fiscal Year 2023 Budget

The development of the FY2023 Budget is a planned, orderly process which prioritizes budget requests using available resources.

Cobb County Schools utilize a centralized resource allocation method that is formula driven based on student FTE and enrollment. This allows the District to efficiently and effectively staff schools. The **District's instructional priorities** are researched and re-evaluated during the budget development process to ensure financial appropriations are allocated to ensure the greatest potential for student achievement.

The budget process includes the estimation of revenues to fund the necessary operating expenditures of the CCSD. Decisions on the appropriation of funds are made after input is received from individuals from inside and outside the school system. All the technical aspects and tasks of budget development are assigned to responsible employees to ensure that accounts, programs and services are reviewed, analyzed and comply with the CCSD Financial Services values: *Hard Work, Dedication, and Consistency*.

General Fund Revenues of Fiscal Year 2023 Budget

CCSD has two primary revenue sources: the State of Georgia Quality Basic Education (QBE) Revenue and the local property tax revenue. The District has been experiencing stable growth in these two revenue sources in recent years:

State QBE Revenue

The State of Georgia provides approximately **44.81%** of the CCSD's revenue from predetermined formulas. The revenue related to these formulas is calculated based on the total number of students and the instructional programs in which these students are involved. Control of this revenue is assured through verification of student population counts which are conducted throughout the school year.

**EXECUTIVE SUMMARY
HIGHLIGHTS OF FY2023 BUDGET (Continued)**

Local Property Tax Revenue

Local Revenues generate approximately **54.52%** of the CCSD’s revenue. The value of property in Cobb is taxed using a tax rate called *millage*. The Board of Education is responsible for setting the millage tax rate each year and this year’s budget proposes no increase to the current millage rate of **18.9 mills**. The CCSD budgets carefully, focusing on expenditure control each year to balance the budget. Administration continually monitors expenditures and implements efficiencies throughout the year to ensure fund availability for support of our students and teachers.

FY2023 Revenue Breakout		FY2023 CCSD Millage Tax Rate	
54.52%	Local Property Tax Funding	18.90 Mills	General Fund Millage
44.81%	State of Georgia QBE Funding	0.00 Mills	Debt Service Millage
0.67%	Federal Program Funding	18.90 Mills	Total Millage
100.00%	Total General Fund Revenue	Note: CCSD is now and has been long-term debt free since FY2007.	

General Fund Expenditures of Fiscal Year 2023 Budget

Cobb County School District uses a conservative approach to budgeting each year. This budgeting practice, combined with responsible financial management and a healthy fund balance, allows CCSD the flexibility to adapt as quickly as possible to changes in the K-12 educational environment.

Each CCSD functional area (school or department) has a detailed budget designed to carry out their operations. All functional areas are required to review each of their revenue and expenditure accounts. FY2023 system-wide school district staffing estimates and requirements are also reviewed as part of the budget balancing process. Administration evaluates and prioritizes school district budget balancing ideas.



EXECUTIVE SUMMARY
HIGHLIGHTS OF FY2023 BUDGET (Continued)

Salary Raise in Expenditures Budget

The District Board of Education approved the FY2023 Budget, which prioritizes students and staff, with an **8.5%-13.1%** salary raise, depending on step eligibility. The historic raise is the highest in metro Atlanta and follows last year's 4.0%-8.6% raise that Superintendent Ragsdale secured for the Cobb Schools team amid a pandemic. A record of the District's salary increases from recent years is listed below.

Recent Budget Accomplishments

FY2015	2% Salary Restoration and Full Salary Step Increase for All Eligible Employees
FY2016	4% Salary Increase and Full Salary Step Increase for All Eligible Employees
FY2017	2.5% Salary Increase and Full Salary Step Increase for All Eligible Employees
FY2018	1.1% Salary Bonus and Full Salary Step Increase for All Eligible Employees
FY2019	2.6% Salary Increase and Full Salary Step Increase for All Eligible Employees 1.1% Salary Bonus (for Non-238 Day Employees)
FY2020	Salary Increase Range 8.00% - 12.6% (depending upon step eligibility) and Full Salary Step Increase for All Eligible Employees
FY2021	Full Salary Step Increase for All Eligible Employees
FY2022	Salary Increase Range 4.00% - 8.6% (depending upon step eligibility) and Full Salary Step Increase for All Eligible Employees
FY2023	Salary Increase Range 8.5% - 13.1% (depending upon step eligibility) and Full Salary Step Increase for All Eligible Employees

EXECUTIVE SUMMARY
HIGHLIGHTS OF FY2023 BUDGET (Continued)

The FY2023 General Fund Budget Highlights:

- \$23 Million State of Georgia QBE Austerity Cut Restoration
- General Fund Millage Rate 18.90 Mills – No Millage Increase (LT Debt Free since 2007)
- Aaa and MIG1 – Highest Moody’s Investors Service Long-Term and Short-Term Credit Rating
- AAA and A-1 – Highest Standard & Poor’s Long-Term and Short-Term Credit Rating
- AAA and K1+ – Highest Kroll Bond Rating Agency’s Long-Term and Short-Term Credit Rating
- Local Revenue Property Value Digest Growth – 10.49%
- 107.30 Instructional Support Positions
- 10.00 School Psychologists
- 5.00 Custodian Positions (Based on square footage)
- (226.50) Position adjustments to accommodate the decrease in students due to the pandemic – Teachers to be added incrementally as students return
- Budgeted Fund Balance Usage – (\$29,851,087)
- Salary Step Increase for All Eligible Employees
- Salary Increase for All Non-Temporary Employees – (Salary increase range 8.5% - 13.1% depending upon step eligibility)

**EXECUTIVE SUMMARY
FEDERAL ESSER FUNDING FOR COVID-19**

Federal ESSER Funds Provide Support to School District for Recovery from Pandemic Impact

In response to the COVID-19 pandemic in the United States, Congress passed three bills that provided immediate and direct economic assistance to state and local educational agencies through the **Elementary and Secondary School Emergency Relief (ESSER)** funds. These funds were provided to support areas with the greatest need, where the academic and non-academic components for school districts had the greatest impact due to COVID-19. As additional funding was provided, the intent of the funds was to support States and local school districts’ efforts to safely reopen schools, address significant gaps in learning, and support measures of implementation that will continue to reduce the effects of COVID-19 on students and families.

There are three rounds of ESSER funding – through the **CARES Act** in May 2020, the **Coronavirus Response and Relief Supplemental Appropriations Act** in January 2021, and the **American Rescue Plan Act** in March 2021.

In FY2022, The District received **\$160.7** million in American Rescue Plan Act funding in Special Revenue funds.

ESSER I	Coronavirus, Aid, Relief & Economic Security (CARES) Act	The funding provides flexibility for states to respond to the COVID-19 emergency in K-12 schools. Funds to local school districts may be used for coronavirus response activities such as planning for and coordinating during long-term school closures, purchasing educational technology to support online learning for all students, and additional activities authorized by federal elementary and secondary education laws.
ESSER II	Coronavirus Response & Relief Supplemental Appropriations (CRRSA) Act	Following the same distribution as the CARES Act, which is based on the share of ESEA Title I, Part A funds follow the same use for coronavirus-response activities. Planning for and coordinating activities that address learning loss, preparing schools for reopening, testing, repairing, upgrading projects to improve air quality in school buildings, and additional activities authorized by federal elementary and secondary education laws are continually permitted.
ESSER III	American Rescue Plan (ARP) Act	The funding allows SEAs to take additional steps to safely reopen schools for in-person instruction and keep them open and to address the disruptions to teaching and learning resulting from the pandemic. Address the many impacts of COVID-19 on students, including from interrupted instruction; implement strategies to meet students’ social, emotional, mental health, and academic needs; offer crucial summer, afterschool, and other extended learning and enrichment programs. Invest in staff capacity and avoid devastating layoffs at this critical moment.

**EXECUTIVE SUMMARY
FEDERAL ESSER FUNDING FOR COVID-19 (Continued)**

CARES I & CARES II Funding

CARES I (\$15.7 million) & CARES II (\$71.5 million) funds received by CCSD have been fully expended during FY2021. The District used these funds to offset State austerity reductions and support continuity of core services in our classrooms.

American Recovery Plan (ARP) Funding

The District received \$160.7 million in ARP funding. The District plans to utilize these funds over a three fiscal year period. Unused funds, or lapsed funds, are redistributed annually based on a collaborative initiative determining District needs and priorities.

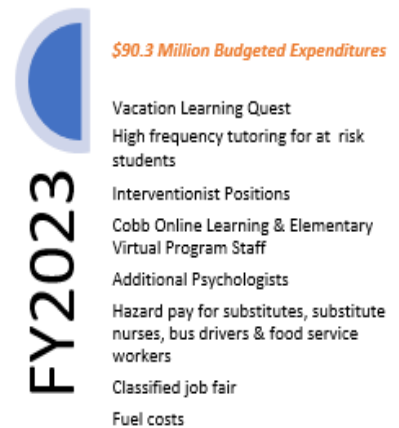
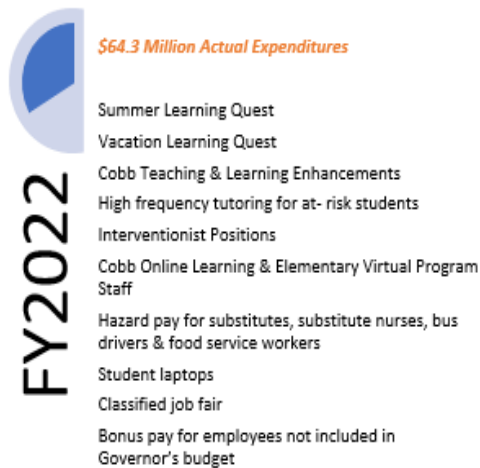

EXECUTIVE SUMMARY CHALLENGES FACED BY THE DISTRICT – STATE REVENUE

How Does the State Budget Impact CCSD?

State Education Budget Overview

The annual budget development process is one of the largest, most complex projects that the District undertakes each year. The District's two primary revenue streams, **State funding** and **Local property tax collections**, must be analyzed to determine the District's anticipated revenues. The State of Georgia also has a planned process for developing the education budget.

The Governor initiates the budget process by requesting all State agencies to submit their budget information to the Office of Planning and Budget (OPB). Legally, the Governor must submit a budget report to the General Assembly within five days of the legislature convening in January. The Assembly takes this report and makes the Appropriation Act. The Appropriation Act is a bill representing the formal law by which state funds are provided to its recipients. The bill is first reviewed by the House and once the bill has been reviewed, amended, and approved by the House, it is transferred to the Senate.

The Senate reviews, amends, and approves their version of the budget which is sent back to the House for approval or rejection. A Conference Committee with members of the House and Senate is formed to come to an agreement on any discrepancies between the two versions of the bill. Once the bill has been passed, it is sent to the Governor for his final approval. The Governor has 40 days to sign the bill before it automatically passes into law. The Governor does have the right of line item veto. The final Appropriation Act gives State agencies their annual operating budget.



District Receives State Funding Based on QBE Formula

State revenue is earned via a formula entitled the **Quality Basic Education (QBE)** Act approved by the State of Georgia legislature. The main criteria for State funding is student population counts. In FY2023, the State contributes approximately **44.81%** of the Cobb County School System's revenue.

$$\text{QBE Fund} = \text{FTE Count} \times \text{Program Weight} \times \text{Training \& Experience Factor} \times \text{Base Amount} \\ \text{Minus Five Mill Share}$$

1. **Full-Time Equivalent** - The funding formula utilizes a concept called Full-Time Equivalent (FTE). The State of Georgia allocates funds to school districts based on their number of full-time students.
2. **Program Weights** - Since different programs (kindergarten, primary grades 1-3, middle school grades 6-8, etc.) vary in their cost of operation, each program is assigned a program weight.
3. **Training & Experience** - The State of Georgia allocates additional funds to school districts to adjust for varying levels of teacher education and years of experience.
4. **Base Amount** - Standard Cost per Student amount established by the State of Georgia. The base amount for FY2023 is \$2,897.28 per student.
5. **Local Five Mill Share** - The Local Share for each local system is an amount of money equal to the amount that can be raised by levying five (5) mills on the forty (40) percent equalized property tax digest.

EXECUTIVE SUMMARY
CHALLENGES FACED BY THE DISTRICT – STATE REVENUE (Continued)

State of Georgia Local Five Mill Share

All school districts electing to receive Quality Basic Education funding from the state are required to levy the equivalent of at least five mills in property taxes as a basic local commitment to educating their students. The “Local Five Mill Share” in the QBE formula refers to the portion of the direct and indirect Instructional Costs that the state expects local systems to pay with locally raised funds.

Currently, the state requires local systems to pay an amount equal to **5 Mills of property tax** generated within their taxing authority. By law, the amount of money represented by the 5 Mills statewide cannot exceed 20 percent of the total QBE formula earnings (direct and indirect instructional costs). Funds that are raised through locally levied property taxes, which include the minimally required five mills share, do not leave the school system. These funds remain with the district/taxing authority and are not directly remitted to the state. The Local Five Mill Share represents each system’s “obligation” toward educating their students in order to participate in the state funding model (QBE).

The latest seven years Local Five Mill Share amounts that are deducted from the State revenue earned by Cobb School District are listed below. It is projected to be **\$184.3** million in the FY2023 budget.

CCSD QBE Mandated Local Fair Share

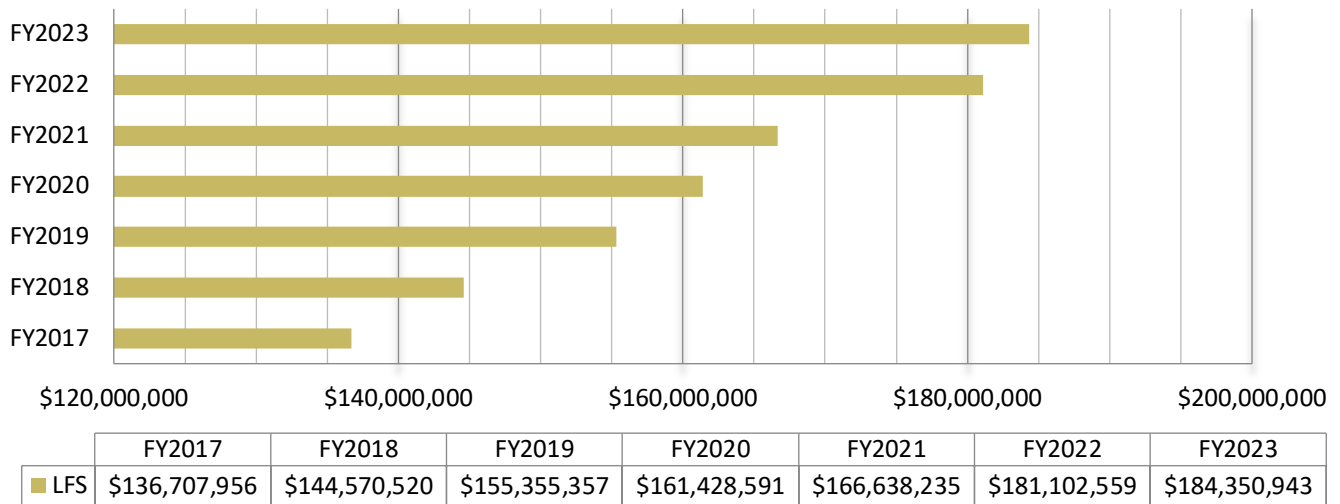

EXECUTIVE SUMMARY
CHALLENGES FACED BY THE DISTRICT – STATE REVENUE (Continued)

State Austerity Budget Cuts

The austerity cut is the gap between the amount of money the State **Quality Basic Education** formula calculates that districts need to provide a quality education to all students and the amount the General Assembly approves. The formula determines the distribution of State dollars to public schools in Georgia’s 180 districts.

In prior years, the State of Georgia faced difficult financial challenges and the State revenue growth was not keeping pace with rising expenditures which forced the State legislature to cut programs and reduce operating costs by enacting austerity budget cuts. Therefore, beginning in FY2003, these austerity budget cuts have reduced the amount of state education funding the District receives. Cobb County ranks as the second largest cumulative QBE cuts to a school district in the State. The total cumulative amount reached **\$586 million** by FY2018.

In FY2019 and FY2020, the State legislature chose to fully fund the QBE formula to support the public school systems across Georgia. However, in response to the COVID-19 pandemic, the Cobb County School District received a \$23.6 million austerity reduction in FY2021. In FY2022 and FY2023, the State resumed full funding and stopped cuts.

The historical State austerity reductions to Cobb County School District are shown in the graph below:

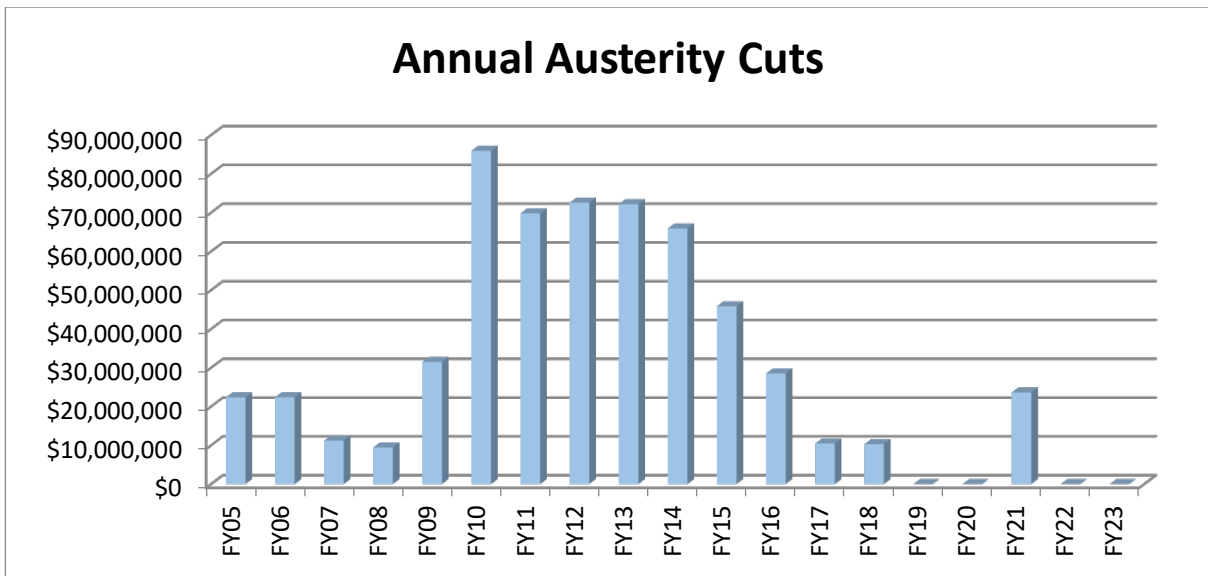

**EXECUTIVE SUMMARY
CHALLENGES FACED BY THE DISTRICT – LOCAL REVENUE**

How Does Local Revenue Property Tax Digest Affect the District?

The Local Revenue for the District is composed of Cobb County local taxes. Tax items include: Property Taxes, Real Estate Transfer, Title Ad Valorem Tax, Intangible Recording Tax, Alcoholic Beverage Tax, Delinquent Property Tax, etc. In the FY2023 Budget, the Local Revenue generates approximately **54.52%** of the CCSD’s revenue.

How Is Property Tax Calculated for the School Portion?

The following is an example of how FY2023 County School Taxes are calculated for a \$325,000 home:

<u>Calculation</u>	<u>Item</u>
\$325,000	House assessed at Fair Market Value
X .40	40% Assessment Rate
\$130,000	Assessed Value for Tax Purposes
(\$10,000)	Homestead Exemption
\$120,000	Tax Base for Property Tax
X .0189	Millage Rate 18.90
\$ 2,268	General Fund School Taxes

Property Tax Digest Growth

The County’s gross digest suffered a significant decrease with negative growth rate due to the nationwide economic downturn and the erosion of real estate values in the years 2009 to 2013. However, 2014 became a turning point with positive property digest growth. We are encouraged by the positive and stable trend in property values since then. A solid property tax digest growth of **11.55%** in 2022 was posted by the County Tax Commissioner Office (for FY2023 School Year)

Local Revenue - Cobb County Property Tax Digest Trend Analysis

Calendar Year	Net M&O Digest	% Change in Net M&O Digest
2013	\$20,476,161,097	-1.28%
2014	\$21,354,845,760	4.29%
2015	\$22,041,698,137	3.22%
2016	\$23,363,789,838	6.00%
2017	\$24,876,784,952	6.48%
2018	\$26,918,246,384	8.21%
2019	\$28,382,745,859	5.44%
2020	\$29,760,597,309	4.85%
2021	\$31,465,512,784	5.73%
2022	\$35,099,714,010	11.55%

EXECUTIVE SUMMARY
CHALLENGES FACED BY THE DISTRICT – LOCAL REVENUE (Continued)

Revenue Loss from Age 62 and Older School Tax Exemption

Georgia tax breaks for seniors vary by county. Some counties go strictly by age, others have income and age restrictions, and then others have no senior exemption for school tax. Cobb County provides **full school tax exemption** for all homeowners age 62 and older.

Cobb’s senior exemption was implemented in 1973 and initially included a \$6,000 income limit. County voters by referendum removed the income limit in 1979. The senior exemption accounts for about two-thirds of homeowners’ total property tax bill and equates to **a full 100 percent exemption for the school tax** portion.

The history of revenue loss for the Cobb County School District related to the Age 62 and older exemption is presented below. The 2022 tax exempt amount (for FY2023 school year) is calculated at **\$167 million**.

Calendar Year	Age 62 & Older Exemption Revenue Loss
2013	\$ 62,354,354
2014	\$ 64,642,279
2015	\$ 70,981,218
2016	\$ 78,946,514
2017	\$ 90,042,136
2018	\$ 101,129,594
2019	\$ 122,730,091
2020	\$ 132,178,610
2021	\$ 144,461,759
2022	\$ 167,343,658

Employee Benefit Cost Impacts

Contribution Rate to Teachers Retirement System

The Teachers Retirement System of Georgia (TRS) computes and updates the Employee and Employer Contribution Rate annually. The TRS Board of Trustees adopted the teacher retirement Employer rate for FY2023 which will be 19.98%. It is a 0.17% increase from the FY2022 rate. The impact of the rate change in the coming school year to the District expenditures budget will be **\$1.3 million**.

EXECUTIVE SUMMARY
CHALLENGES FACED BY THE DISTRICT – LOCAL REVENUE (Continued)

TRS Employer and Employee Contribution Rates

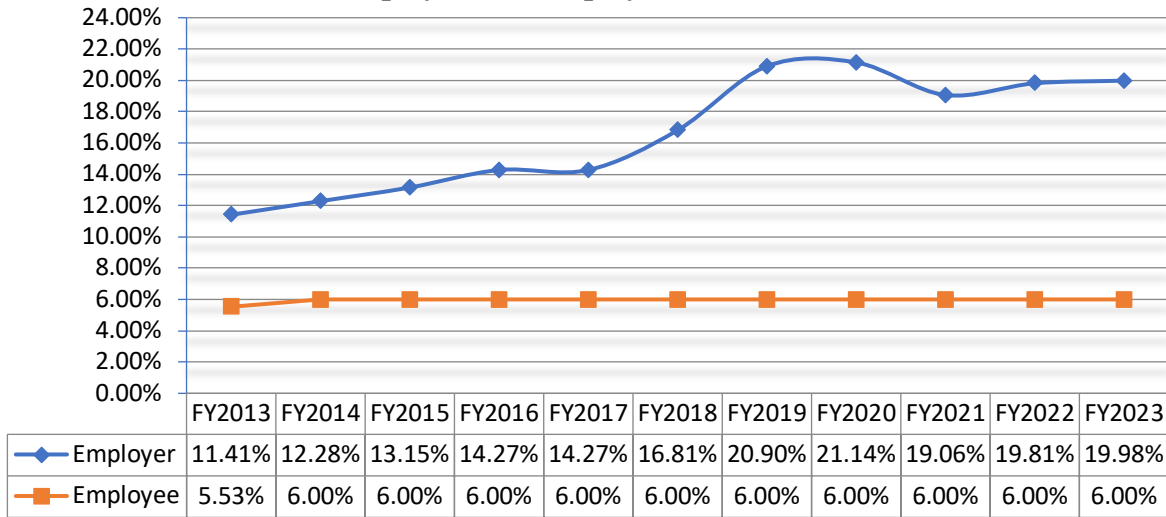

How Does COBB Compare?

Metro Atlanta School Tax Comparison

Based on FY2022 (2021 Digest) millage rates adopted by Metro Atlanta school districts and a median home value of **\$325,000**.

School Locality	Standard Homestead Exemption	Tentative General Fund Millage Rate	Tentative Bond Millage Rate	Taxes on a \$325,000 Home
Atlanta (APS)	\$50,000	20.740	0.000	\$1,659
Cobb	\$10,000	18.900	0.000	\$2,268
DeKalb	\$12,500	23.080	0.000	\$2,712
Fulton	\$2,000	17.590	0.000	\$2,252
Gwinnett	\$4,000	19.700	1.650	\$2,690

Metro Atlanta School Expenditures per Student FTE

The Cobb County School District has historically spent more on Instruction and less on General Administration per full-time equivalent (FTE) than most other metro districts. Full-Time Equivalent (FTE) refers to data collected for Quality Basic Education funding and is based on student enrollment and the education services provided by local school systems to students. As noted in the table below, Cobb’s **General Administrative costs**, \$195 per FTE, is significantly lower than that of other metro Atlanta districts and constitutes only **2.03%** of total expenditures. Cobb has established itself leading Metro Atlanta when comparing the **expenditures on Instruction** at \$6,696 (or **69.81%**) per FTE and high achievement on SAT scores.

EXECUTIVE SUMMARY
CHALLENGES FACED BY THE DISTRICT – LOCAL REVENUE (Continued)

Comparison of Metro Districts General Fund Expenditures per Student FTE Count					
School District	<u>Atlanta</u>	<u>Cobb</u>	<u>DeKalb</u>	<u>Fulton</u>	<u>Gwinnett</u>
Instructional	\$ 11,270	\$ 6,696	\$ 7,609	\$ 7,419	\$ 6,164
	67.63%	69.81%	65.29%	64.06%	65.50%
	<i>Percentage of Total Expenditures for Instructional Funding</i>				
Media	\$ 104	\$ 156	\$ 146	\$ 192	\$ 125
Instruction Support	\$ 1,079	\$ 387	\$ 360	\$ 921	\$ 565
Pupil Services	\$ 945	\$ 299	\$ 667	\$ 792	\$ 303
General Admin	\$ 321	\$ 195	\$ 547	\$ 256	\$ 202
	1.93%	2.03%	4.69%	2.21%	2.15%
	<i>Percentage of Total Expenditures for General Administration Funding</i>				
School Admin	\$ 791	\$ 699	\$ 756	\$ 672	\$ 804
Transportation	\$ 595	\$ 442	\$ 491	\$ 548	\$ 550
Maint & Operations	\$ 1,537	\$ 696	\$ 1,073	\$ 781	\$ 694
Debt Services	\$ 19	\$ 0	\$ 0	\$ 0	\$ 0
School Food Service	\$ 3	\$ 4	\$ 4	\$ 0	\$ 3
Renovation & Cap Project	\$ 0	\$ 17	\$ 0	\$ 0	\$ 0
Total *	\$ 16,664	\$ 9,592	\$ 11,654	\$ 11,582	\$ 9,410
SAT Scores **	927	1150	1037	1128	1132
School Taxes ***	\$ 1,659	\$ 2,268	\$ 2,712	\$ 2,278	\$ 2,690

*Based on 2020-2021 State Report Card information (the latest available from Governor’s Office of Student Achievement)

** SAT scores based on the data released by State DOE on 2020-2021 high school graduates test results

*** Taxes based on FY2022 (2021 Digest) Millage Rate and Homestead Exemptions calculated on a \$325,000 value home

EXECUTIVE SUMMARY
BUDGET ASSUMPTIONS/INITIATIVES AND CONSTRAINTS

The operating budget was developed in conformance with the District policy, Financial planning, Programming, Budget System, which includes the guidelines in both assumptions and constraints areas as noted below.

ASSUMPTIONS/INITIATIVES

A. **Enrollment** – In November of each year, enrollment projections for the forthcoming school year are made in collaboration with the District’s Accountability & Research Department and the Financial Planning & Analysis Department. These projections are used to prepare the proposed revenue and expenditure budget to ensure successful schools and educational programs. The methodology of forecasting is to review the historical trends in enrollment data at each grade level for each school. In addition, the projections took into consideration the **Enrollment Study Annual Update** developed for the District by Educational Planners, LLC., (February 2022), as well as a review on the population and housing data of the Atlanta Regional Commission (ARC). The following table presents the past five years of active enrollment data and a projection for future years:

Five Year History	FY2018	FY2019	FY2020	FY2021	FY2022
Enrollment	111,482	111,386	111,760	106,983	106,617
Growth Rate	-	(0.09%)	0.33%	(4.30%)	(0.34%)

Projection	FY2023	FY2024	FY2025	FY2026
Enrollment	106,732	107,799	108,877	109,966
Growth Rate	0.11%	1.00%	1.00%	1.00%

B. **Personnel** – School-level staffing of teachers, paraprofessionals, counselors, media specialists, assistant principals, and clerks are determined based on the enrollment FTE (Full-Time Equivalency) and the personnel allotment formulas. Personnel needs are analyzed so that existing and projected new students are served according to state and local mandates.

The teacher/paraprofessional allotment formulas comply with State mandated maximum average class size, State waivers of class size requirement (State BOE rule 160-1-3-.02 Suspension of Rules and Laws), as well as the Pandemic Planning: Information for Georgia Public School District, that were issued by the State Department of Education. The formulas also comply with accreditation agency requirements, such as COGNIA.

C. **Economic Factor** – With the current economic conditions, inflation factor will be closely monitored this year. In general, operating budgets are continued unless there are new approved School District projects or initiatives. Individual account budget estimates (utility rates, etc.) are developed by contacting outside entities or collecting information from reliable sources to ensure that the District’s proposed budget is as realistic as possible.

EXECUTIVE SUMMARY
BUDGET ASSUMPTIONS/INITIATIVES AND CONSTRAINTS (continued)

<p>D. <u>Lapse Analysis</u> – Budgets are developed each year using a realistic, but conservative, approach. In spite of this approach, there are expenditure accounts that finish the year under-budget. This under-budget amount is referred to as <i>lapse</i>. This can happen for a variety of reasons such as budgeting insurance for an employee who does not request insurance. In this case, the budget is not utilized and these funds revert to fund balance at the end of the year. Lapse can also occur as a result of over collections of revenue. Because of the District’s realistic budget approach, the effect of lapse on the District’s fund balance should be minimal.</p>
<p>E. <u>Formula Driven Budget/Academic Program Priority Driven Budget</u> - A formula driven budget is prepared by the Financial Services Division using the enrollment projections and personnel allotments furnished by the Accountability Division and Leadership Division to determine availability of funds for improvement and new programs. Only the longevity step increase is used for personnel salary calculations. Existing program appropriations are evaluated and one-time costs are eliminated.</p>
<p>F. <u>Student Supply Allocations</u> – FY2023 Elementary schools are allotted supplies at the rate of \$37 per student. Middle schools are allotted supplies at the rate of \$45 per student. High schools are allotted supplies at the rate of \$53 per student.</p>
<p>G. <u>Salary Improvements</u> - Salary improvements are recommended based on the proposed State increase with adjustments as specified in the District's goals and objectives as approved by the Board. In addition to a Salary Step Increase each year, salary improvements in prior years include a 2.5% raise in FY2017, a 1.1% bonus in FY2018, a 2.6% raise in FY2019, a salary increase range of 8.0%-12.6% (depending on step eligibility) for all non-temporary employees in FY2020, a salary increase range of 4.0%-8.6% (depending on step eligibility) for all non-temporary employees in FY2022 , and a salary increase range of 8.5%-13.1% (depending on step eligibility) for all non-temporary employees in FY2023.</p>
<p>H. <u>Program Evaluation</u> - New programs are recommended for consideration in the enhancement budget and are considered based on their contribution to District-wide and school-level objectives.</p>
<p>I. <u>Equipment</u> – The equipment, furniture, and vehicle budgets are zero-based each year. All new and replacement equipment must be itemized and will be considered individually by the Budget Committee.</p>
<p>J. <u>Facilities</u> - Renovations of existing facilities and new facilities to be constructed are funded through the Special Purpose Local Option Sales Tax (SPLOST). Renovations to school facilities such as HVAC units, roofs, painting, etc. impact the General Fund. Because of these new items and new product efficiencies, there is a reduced need for increased general maintenance budgets in the General Fund. All General Fund maintenance accounts are reviewed annually to estimate and budget savings.</p>
<p>K. <u>Student Transportation</u> – Transportation is provided to students and is partially funded using State categorical grant funding. The majority of transportation is funded through local property taxes. Each year, the number of bus drivers and buses is analyzed based upon the projected number of students the District is anticipated to serve.</p>

EXECUTIVE SUMMARY
BUDGET ASSUMPTIONS/INITIATIVES AND CONSTRAINTS (continued)

L. Financial Impact of Non-Routine Capital Expenditures

School District building square footage is reviewed each year to account for new schools and classroom additions. Additional maintenance budgets are requested each year to provide for building maintenance (general maintenance supplies, custodians, etc.). Utility companies are contacted annually to ascertain the most current rate estimates. These estimates are used to budget utilities (existing and new buildings) for the new school year.

M. Fringe Benefit Estimates for FY2023

FRINGE BENEFIT	FY2023 PROJECTION
Group Insurance - Certified	\$945.00 per member per month
Group Insurance - Classified	\$945.00 per member per month
Social Security	6.20% of Gross Salary
Medicare	1.45% of Gross Salary
Teacher's Retirement System (Certified, Administrators, Clerical, Aides)	19.98% of Gross Salary
Unemployment	\$20 – Annual Employee Cost
Workers Compensation	
Teachers, Administrators, Clerical, Aides	0.47% of Gross Salary
Bus Drivers	6.71% of Gross Salary
All Other	4.08% of Gross Salary

CONSTRAINTS

A. **State Revenue** – The State fully funded the Quality Basic Education formula in FY2023 without austerity cuts in beginning budget projection. However, the Local Fair Share (LFS) continues to be deducted from State revenue to the District. The FY2023 LFS is budgeted at **\$184.3** million dollars.

B. **Local Tax Revenue** – For FY2023, the Cobb County School District is estimating a property tax digest with **10.49 %** growth. The Board approved the millage rate **18.9 mills**. It is the same rate imposed in FY2022.

C. **Uncommitted Fund Reserve** – For cash flow purposes (Payroll and Vendor Payments), a minimum one month cash reserve is recommended by the Financial Services Division. Current Board Policy ([Policy DI](#)) directs the District to maintain a minimum unassigned fund balance in its General Fund of at least **8.33%** of budgeted expenditures.

2022-2023

LEGISLATIVE PRIORITIES



1 FINANCIAL SUSTAINABILITY

- Sustain current levels of funding for therapeutic supports for students with disabilities
- Oppose diversion of funds from public education

2 EDUCATIONAL ACCESS

- Sustain Teachers Retirement System as currently structured
- Establish opportunities for additional pathways to graduation
- Incentivize higher education for teachers
- Apply charter waivers to SWSS systems

3 ACCURACY IN ACCOUNTABILITY

- Apply the same standards of accountability to all recipients of public money for education
- Revise SB 68 to require quarterly financial updates instead of monthly
- Streamline the complaint processes found in HB 1084, HB 1178, and SB 226

ONE TEAM. ONE GOAL.
STUDENT SUCCESS.

 **108,727**
STUDENTS

 **112**
SCHOOLS

22 NATIONAL BLUE RIBBON SCHOOLS

56 GEORGIA SCHOOLS OF EXCELLENCE



DIVERSE STUDENT DEMOGRAPHICS

34.0% CAUCASIAN | 30.1% BLACK | 25.1% HISPANIC | 5.8% ASIAN | 5.4% OTHER



2ND LARGEST
SCHOOL DISTRICT IN GA



25TH LARGEST
SCHOOL DISTRICT IN
AMERICA OUT OF MORE
THAN 14,000 DISTRICTS

\$106,000,000 IN SCHOLARSHIP MONEY
AWARDED TO THE CLASS OF 2021

#1 IN THE
METRO
ON 2019
GA MILESTONES

AAA
CREDIT RATING

 **STUDENT SAFETY**
& SECURITY IS PARAMOUNT

 **1,048**
BUSES



EMPLOYMENT

LARGEST
EMPLOYER IN COBB COUNTY

16,879 EMPLOYEES

73%
TEACHERS WITH ADVANCED DEGREES
Page 33

37 NEW AND REPLACEMENT SCHOOLS
HAVE BEEN BUILT SINCE 1998
DUE TO FUNDING PROVIDED BY
Ed-SPLOST

THE COBB COUNTY SCHOOL DISTRICT EMPLOYS
70 POLICE OFFICERS DEDICATED TO THE
SAFETY OF EACH STUDENT
AND SCHOOL IN THE DISTRICT



WORKFORCE DEVELOPMENT

2,540
OVERALL PATHWAY
COMPLETERS

INDUSTRY CREDENTIALS ISSUED
2,240



HEALTH

OUR AVERAGE HEALTH
INSPECTION SCORE WAS
99.10%

135
SCHOOL NURSES WORK FOR THE
COBB COUNTY SCHOOL DISTRICT

2022-2023
SCHOOL YEAR
AT A GLANCE



**EXECUTIVE SUMMARY
COMMUNITY DEMOGRAPHIC AND FINANCIAL INFORMATION**

State of Georgia

Georgia is a state in the southeastern region of the United States. Georgia is the 24th largest in area and 8th most populous of the 50 States. Its 2021 population was 10,799,566, according to the US Census Bureau.



Georgia Economic Information



- In 2021, Georgia’s **total trade** with the world reached \$166.11 billion, spanning 223 countries and territories, ranking 7th in total trade value in the U.S.
- Georgia set a record for **exports** of \$42.36 billion in 2021, growing 9% from 2020. The State currently ranks 12th in the U.S. Major export products include civilian aircraft, motor cars, parts of gas turbines, etc.

- Georgia **imports** totaled \$123.74 billion in 2021, an increase of 25 percent over the previous year. Top imports were motor vehicles, food preparations, immunological products, etc.
- The Port of **Savannah** moved 4.75 million 20 foot equivalent container units (TEUs) over the first 10 months of FY 2022 (July-April), up 8 percent.
- For year-end June 30, 2022, the State of Georgia net tax collections totaled \$33.09 billion for an overall increase of \$6.19 billion, or **23 percent**, compared to Fiscal Year 2021 during which final net tax revenues approached \$26.90 billion.



EXECUTIVE SUMMARY
EXPLANATION OF COMMUNITY FINANCIAL AND DEMOGRAPHIC INFORMATION
(Continued)

Cobb County

Cobb County is located in the northwest quadrant of the Atlanta metropolitan area.

- The U.S. Census Bureau ranks Cobb County as the 4th most-educated in the state of Georgia and among the top 3% of all counties in the United States.
- It has ranked among the top 100 wealthiest counties in the United States.

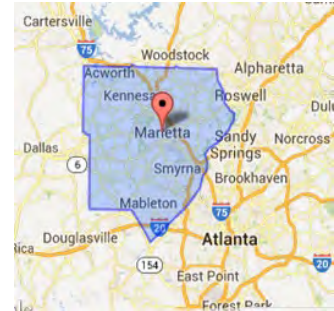

Demographics

Information source: United States Census bureau, Estimates: July 1, 2021.

Cobb County Government - Economic Development Office

Population

766,802 (2021 estimate)

Race

- White: 50.2%
- African American: 29.2%
- Hispanic: 13.7%
- Asian: 5.7%
- Other: 1.2%



Age Ranges

Average 36.8 years of age

- < 24 years: 32.2%
- 25 – 64 years: 55.0%
- > 65 years: 12.8%

Employment and Income

- Civilian employed population 16 Years and over: 431,224
- Median household income: \$81,212
- Per capita income: \$42,008

Education

- High School Graduates: 15.8%
- Associate's Degree: 7.5%
- Bachelor's Degree: 31.2%
- Graduate or Professional degree: 17.7%



Economics and Business Industries

Cobb County is located right next to Metropolitan Atlanta that is a national center for finance, transportation, distribution, and communications. These factors, coupled with a mild climate, beautiful natural environment, affordable housing, and a first-class international airport, help to consistently place Atlanta at or near the top of surveys identifying the most desirable U. S. cities to locate a business.

EXECUTIVE SUMMARY
EXPLANATION OF COMMUNITY FINANCIAL AND DEMOGRAPHIC INFORMATION
(Continued)



Many top industries are currently providing employment and developing business in **Cobb County**. The County has distinguished itself with a variety of assets to support continued development of these industries such as its proximity to the *Hartsfield-Jackson International Airport* with air freight capacity, strong interstate networks, high-volume ports, and lower cost of land. Cobb ranks in the top 20 most affordable metro areas in the United States.



- Cobb is home to over 13% of households earning \$200,000 or more in Georgia even though it comprises only 7.5% of the total households in the state.
- Cobb median incomes are much higher than state and national averages and can be attributed to a highly skilled and educated workforce, the presence of specialized industries, and a high concentration of dual-income households.

Income Distribution

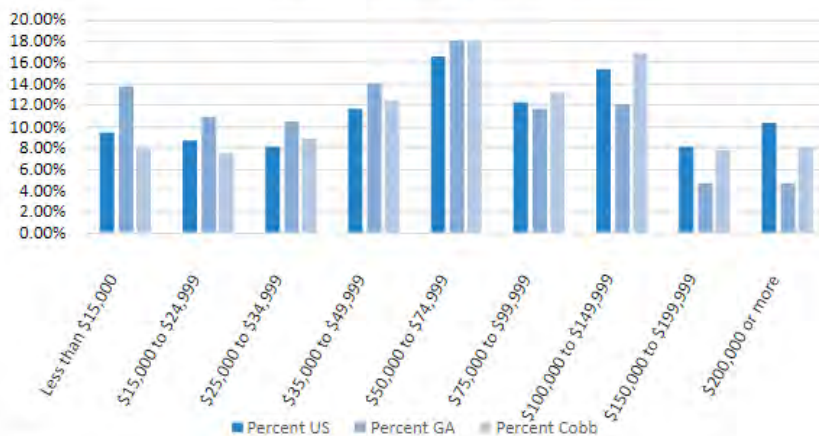

FY2023 BUDGET DEVELOPMENT TIMELINE AND CALENDAR

The budget preparation process extends for a period of approximately twelve months beginning in July. All funds are budgeted by the district on an annual basis. The fiscal year (July 1 through June 30) budget must be submitted to the local seven-member Board of Education for legal adoption prior to July 1. The following are the major elements included in the school district budget process:

PREPARE BUDGET ANALYSIS & GATHER BUDGET-RELATED INFORMATION JULY-JANUARY

- Prepare budget calendar and budget procedures
- Prepare preliminary budget forecast
- Gather budget balancing information (schools & departments)
- Prepare school district personnel allotment projections
- Prepare operational department projections
- Prepare revenue projections
- Prepare revenue/expenditure estimates for other funds

TRACK ACTIVITIES THAT COULD IMPACT BUDGET DEVELOPMENT JULY - JUNE

- Administration tracks and reports legislative activities

TAX DIGEST UPDATE MARCH

- Annual Meeting with Cobb Tax Assessor to update Cobb County Government entities regarding the development of the tax digest and digest growth

BUDGET BOARD MEETINGS AND TENTATIVE BOARD BUDGET APPROVAL APRIL

- Board of Education/Administrators review proposed budget; Board of Education adopts a Tentative Budget – April 21, 2022

BUDGET INPUT FROM COBB COUNTY CITIZENS ON FY2022 TENTATIVE BUDGET AND ON THE AMERICAN RESCUE PLAN (ARP) ACT APRIL-MAY

- Board of Education gathers budget input and American Rescue Plan (ARP) Act input from Citizens at FY2023 Budget Public Forums – April 21, 2022 at 6:30 PM, May 19, 2022 at 6:30 PM.

FINAL BUDGET APPROVAL BY THE COBB COUNTY BOARD OF EDUCATION MAY

- Board of Education approves FY2023 Final Budget – May 19, 2022 at 7:00 PM.

**EXECUTIVE SUMMARY
FY2023 PERSONNEL RESOURCE CHANGES – GENERAL FUND**



(In FTE Basis)

GENERAL FUND	FY2019 Revised Budget	FY2020 Revised Budget	FY2021 Revised Budget	FY2022 Revised Budget	FY2023 Approved Budget
Instructional School Positions					
Kindergarten Teachers	355.00	348.00	360.00	299.00	325.00
Kindergarten Early Intervention Program	132.50	129.00	135.00	120.00	126.00
Grades 1-3	1,027.00	1,016.00	1,022.50	960.50	952.00
Grades 1-3 Early Intervention Program	277.00	286.50	295.00	312.00	302.00
Grades 4-5	589.00	581.00	581.00	553.00	537.00
Grades 4-5 Early Intervention Program	185.00	186.00	194.50	203.50	208.00
Elementary Specialists	229.50	229.00	228.00	218.00	219.00
Grades 6-8	835.00	850.00	864.50	839.50	810.50
Grades 9-12/Alternative Program	1,083.50	1,074.50	1,070.00	1,074.50	1,083.50
Virtual Learning Teachers	11.00	11.00	11.00	11.00	11.00
Career & Technology	117.50	115.00	121.50	133.00	131.50
ROTC	28.00	28.00	28.00	28.00	28.00
IEL Intensive English Language Teacher	32.50	31.50	31.50	27.00	27.00
Discretionary Staff - Certified	59.11	163.11	31.11	283.61	107.11
Tech Instructional Specialist TTIS	20.00	20.00	20.00	20.00	20.00
Magnet Coordinators & Teachers	18.00	18.00	18.00	18.00	18.00
English as a Second Language - ESOL	191.50	190.00	209.50	214.00	220.50
Gifted	541.00	547.00	563.50	580.00	559.00
Remedial Education Teachers	223.50	240.00	250.50	255.50	301.00
PBIS Positive Behavior Intervention	1.00	0.00	0.00	0.00	0.00
Special Ed - Teachers	1,255.00	1,255.00	1,300.00	1,300.00	1,300.00
Special Ed - Preschool Teachers	79.50	79.50	79.50	79.50	79.50
Special Ed - Parapros	452.00	452.00	452.00	452.00	452.00
Special Ed - Preschool Parapros	137.00	137.00	137.00	137.00	137.00
In School Suspension Parapros	41.00	41.00	41.00	42.00	42.00
Kindergarten Parapros	355.00	348.00	360.00	299.00	324.00
Other Instructional Parapros	230.60	228.10	228.10	213.20	233.00
Virtual Learning Parapros	16.00	16.00	16.00	16.00	17.00
Media Specialists	126.00	126.00	125.00	126.00	127.00
Total Instructional School Positions	8,648.71	8,746.21	8,773.71	8,814.81	8,697.61
Other School Support Positions					
Principals	109.00	109.00	108.00	109.00	109.00
Assistant Principals	229.00	228.00	229.00	224.00	219.00
Cobb Horizon Parent Facilitator	1.00	0.00	0.00	0.00	0.00
Program Director/Coordinator/Admin	1.00	2.00	2.00	4.00	6.00
Counselors (Elementary, Middle, High)	257.50	258.50	259.00	253.00	252.00
Local School Secretary	109.00	109.00	110.00	111.00	111.00

**EXECUTIVE SUMMARY
FY2023 PERSONNEL RESOURCE CHANGES – GENERAL FUND (Continued)**



(In FTE Basis)

GENERAL FUND	FY2019 Revised Budget	FY2020 Revised Budget	FY2021 Revised Budget	FY2022 Revised Budget	FY2023 Approved Budget
Local School Bookkeeper	111.50	111.00	111.00	112.50	112.50
Local School Clerical	274.00	270.50	272.50	269.00	273.00
Interpreters – ESOL/ Foreign Language	12.00	12.00	12.00	12.00	12.00
Parent Resource Specialist at IWC	0.00	0.00	0.00	8.00	8.00
Interpreters – Special Ed	7.00	7.00	7.00	7.00	7.00
Diagnosticians	4.00	4.00	4.00	4.00	4.00
Diagnosticians - Preschool	4.00	4.00	4.00	4.00	4.00
Audiologists	3.30	3.30	3.30	3.30	3.30
Occupational Therapists	9.30	9.30	9.30	9.30	9.30
Physical Therapists	6.40	6.40	6.40	6.40	6.40
Speech Language Pathologist (SLP)	191.00	191.00	191.00	191.00	191.00
SLP Parapros	4.00	4.00	4.00	4.00	4.00
Special Ed Nurses	12.38	12.50	12.50	12.50	12.50
SpEd School Based Leadership AP	85.00	85.00	85.00	85.00	85.00
School Nurses & Consulting Nurses	102.80	116.00	117.00	118.00	116.00
Hospital / Homebound	2.00	3.00	3.00	3.00	3.00
Special Ed Preschool Specialist	1.00	1.00	1.00	1.00	1.00
Tech Specialists – Tech Dept	71.00	71.00	71.00	73.00	73.00
Psychologists	40.25	40.25	40.25	40.25	50.25
Social Workers	33.00	33.00	33.00	33.00	33.00
Campus Officers	47.00	49.00	49.00	50.00	50.00
Custodians	592.85	600.35	617.35	623.85	628.85
Bus Monitors	60.00	60.00	60.00	60.00	60.00
Bus Drivers (Regular & Sp Ed)	849.00	849.00	859.00	859.00	859.00
Maintenance	139.00	139.00	139.00	139.00	139.00
Mechanics – Fleet Maintenance	49.00	49.00	49.00	49.00	49.00
Total Other School Support Positions	3,417.28	3,437.10	3,468.60	3,478.10	3,491.10
Central Office Support Positions					
Division 1 – General Administration	19.00	16.00	16.00	16.50	16.50
Division 2 – Operational Support	53.25	53.25	54.25	71.25	71.25
Division 2 – Human Resources	45.10	45.50	45.00	47.00	50.50
Division 3 – Technology	60.50	59.50	58.50	58.50	60.00
Division 3 – Accountability & Research	35.50	36.50	36.50	37.50	42.50
Division 4 – Academics-Teach & Learn	66.78	66.78	66.78	66.78	66.78
Division 4 – Academics-Special Ed Svcs	19.00	24.00	26.00	26.00	26.00
Division 5 – Leadership	18.00	17.00	17.49	17.49	17.49
Division 6 – Financial Services	54.70	54.65	54.65	54.65	56.65
Total Central Office Support Positions	371.83	373.18	375.17	395.67	407.67
Grand Total – General Fund Positions	12,437.82	12,556.49	12,617.48	12,688.58	12,596.38

EXECUTIVE SUMMARY
FY2023 PERSONNEL RESOURCE CHANGES – GENERAL FUND (Continued)

PERSONNEL RESOURCE CHANGES – GENERAL FUND

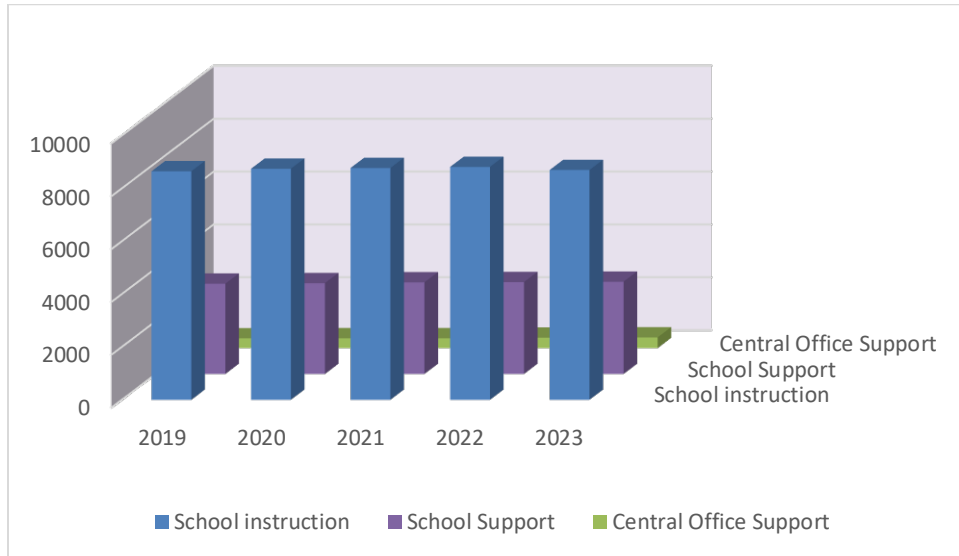

STAFF/STUDENT ENROLLMENT RATIO – GENERAL FUND

School Year	FY2019	FY2020	FY2021	FY2022	FY2023 Projection
General Fund Positions	12,437	12,556	12,617	12,689	12,596
Student Enrollment	111,386	111,760	106,983	106,601	106,732
Staff/Student Ratio	1: 8.87	1: 8.90	1: 8.48	1: 8.40	1: 8.47

EXECUTIVE SUMMARY
FY2023 PERSONNEL RESOURCE CHANGES – GENERAL FUND (Continued)

FY2019

1. A 2.6% Raise for All Eligible Employees
2. A 1.1% Bonus for All Eligible non-238 Day Employees
3. A Decrease to a 236 Day Work Year (with no decrease in salary) for 238 Day Employees
4. Full Salary Step increase for All Eligible Employees

FY2020

1. Salary Increase for all Non-Temporary Employees (range 8.0%-12.6% depending upon Step eligibility)
2. 90 Position Pool
3. School Nurse Steps
4. Campus Officer competitive salary adjustment
5. Full Salary Step Increase for All Eligible Employees

FY2021

1. Full Salary Step Increase for All Eligible Employees
2. 24 Instructional Support Positions
3. Staffing for Cobb Innovation & Technology Academy (CITA) – 12 Positions, and for the Early Learning Center – 10 Positions
4. 13 Custodian Positions (Based on square footage)

FY2022

1. 26.00 Instructional Support Positions
2. Staffing new Susan Todd Pearson Middle School - 10.1 positions, the Cobb Innovation & Technology Academy (CITA) – 4.00 Positions
3. 6.50 Custodian Positions, 2.00 Technology Customer Care positions
4. Full Salary Step Increase for All Eligible Employees
5. Salary Increase for All Non-Temporary Employees – (Salary increase range 4.0% - 8.6% depending upon step eligibility)

FY2023

1. Add 107.30 Instructional Support Positions
2. Add 10 School Psychologists; add 5.0 Custodian Positions (Based on square footage)
3. Full Salary Step Increase for All Eligible Employees
4. Salary Increase for All Non-Temporary Employees – (Salary increase range 8.5% - 13.1% depending upon step eligibility)



**EXECUTIVE SUMMARY
FY2023 PERSONNEL RESOURCE CHANGES – OTHER FUNDS**



(In FTE Basis)

OTHER FUNDS	FY2019 Revised Budget	FY2020 Revised Budget	FY2021 Revised Budget	FY2022 Revised Budget	FY2023 Approved Budget
SPLOST 4	0.00	0.00	0.00	0.00	0.00
SPLOST 5	34.62	34.12	34.12	33.05	33.05
Title I	194.35	179.60	170.60	169.60	171.10
IDEA	310.90	333.40	322.60	312.00	312.00
CTAE	0.00	0.00	0.00	0.00	0.00
Title II - A	10.98	10.99	10.99	10.98	10.98
CARES Act Relief Fund	0.00	0.00	0.00	0.00	0.00
Homeless Grant	0.00	0.00	0.00	0.00	0.00
American Rescue Plan Act	0.00	0.00	0.00	215.00	215.00
Federal Funded Grants	0.00	0.00	0.00	0.00	0.00
Title III – A (LEP)	7.20	7.50	6.05	6.05	6.05
Title IV – A & B	1.00	2.50	3.40	3.36	3.36
Adult Education	7.00	7.00	7.00	7.00	7.00
GNETS	56.35	46.25	46.25	38.25	38.25
Venue Management	2.00	2.00	2.00	4.00	0.00
After School Program	4.10	4.10	4.10	4.10	4.10
Tuition School	1.00	1.00	1.00	1.00	1.00
Public Safety	21.00	21.00	21.00	21.00	21.00
Adult High School	2.60	2.60	2.60	2.60	2.60
Pre-Kindergarten (Lottery)	1.38	1.00	1.00	6.00	8.00
School Nutrition Service	1,218.00	1,216.00	1,216.00	1,216.00	1,216.00
Self-Insurance	5.00	5.00	5.00	5.69	5.69
Purchasing	15.90	15.90	17.00	0.00	0.00
Flexible Benefits	1.00	1.00	1.00	0.00	0.00
Grand Total – Other Funds Positions	1,894.38	1,890.96	1,871.71	2,055.68	2,055.18

The District FY2023 Personnel total 14,651.56 (in FTE basis) including General Fund and Other Funds positions.



**EXECUTIVE SUMMARY
COBB COUNTY SCHOOL DISTRICT
FIVE YEARS GENERAL FUND FORECAST**

Type	Category	FY2022 Board Approved Revised Budget	FY2023	FY2024	FY2025	FY2026	FY2027	FY2028	Assumptions	
1 Local	Property Tax Revenue	\$564,026,799	\$629,045,845	\$660,498,137	\$693,523,044	\$728,199,196	\$764,609,156	\$802,839,614	<u>Property Digest Information</u> FY2023 Projected Digest 10.49% FY2024 Projected Digest 5.00% FY2025 Projected Digest 5.00% FY2026 Projected Digest 5.00% FY2027 Projected Digest 5.00% FY2028 Projected Digest 5.00%	
2	Other Tax Revenue	\$66,872,353	\$77,043,779	\$77,043,779	\$77,043,779	\$77,043,779	\$77,043,779	\$77,043,779		Constant
3	Other Local	\$4,578,960	\$4,515,173	\$4,515,173	\$4,515,173	\$4,515,173	\$4,515,173	\$4,515,173		Constant
4 State	Miscellaneous State Grant	\$6,208,120	\$5,599,461	\$5,599,461	\$5,599,461	\$5,599,461	\$5,599,461	\$5,599,461		Constant
5	QBE	\$535,357,204	\$578,512,537	\$578,512,537	\$578,512,537	\$578,512,537	\$578,512,537	\$578,512,537		Constant
6 Federal	Indirect Cost	\$4,006,460	\$5,606,481	\$4,517,147	\$4,517,147	\$4,517,147	\$4,517,147	\$4,517,147		Constant
7	ROTC	\$1,204,272	\$1,239,971	\$1,072,281	\$1,072,281	\$1,072,281	\$1,072,281	\$1,072,281	Constant	
8	MedAce	\$1,117,141	\$1,138,479	\$985,295	\$985,295	\$985,295	\$985,295	\$985,295	Constant	
9	Medicaid	\$689,545	\$707,716	\$557,630	\$557,630	\$557,630	\$557,630	\$557,630	Constant	
10	Revenue Total	\$1,184,060,854	\$1,303,409,442	\$1,333,301,440	\$1,366,326,347	\$1,401,002,499	\$1,437,412,459	\$1,475,642,917		
11	Reserve Available	\$71,687,571	\$29,851,087	\$-	\$-	\$-	\$-	\$-		
	Total Funds Available	\$1,255,748,425	\$1,333,260,529	\$1,333,301,440	\$1,366,326,347	\$1,401,002,499	\$1,437,412,459	\$1,475,642,917		
12 Base	FY22 Revised Budget	\$1,255,748,425								
13	FY23 Proposed Budget		\$1,333,260,529							
14	Prior Year Continuation Budget			\$1,333,260,529	\$1,348,786,065	\$1,364,521,984	\$1,380,971,442	\$1,398,137,641		
15 Salary/Benefits	Annual Step Increase			\$14,025,536	\$14,235,919	\$14,449,458	\$14,666,200	\$14,886,193	Annual Step Increase for All Eligible Employees Estimated based on historical trends	
16	Increased Benefit Cost			\$1,500,000	\$1,500,000	\$2,000,000	\$2,500,000	\$3,000,000		
12 Base	FY22 Loan to SPLOST6	\$3,464,951								
	Expenditure Total	\$1,259,213,376	\$1,333,260,529	\$1,348,786,065	\$1,364,521,984	\$1,380,971,442	\$1,398,137,642	\$1,416,023,834		
	Forecasted (Deficit)/Surplus	(\$3,464,951) \$-		(\$15,484,625)	\$1,804,363	\$20,031,058	\$39,274,818	\$59,619,083		

Conservative Budget Practices – Cobb County School District utilizes realistic, but conservative, budgeting practices when developing the annual budget, in both Revenue and Expenditure estimates. Regarding revenues, these estimates could include budgeting the lower amount of a given range of estimated receipts or being cautiously optimistic about the amount of revenues to be received from a given source, among other factors. For expenditures, these assumptions could include budgeting for all positions to be filled for the full year, assuming all new employees will elect health insurance coverage, and budgeting Teachers' salaries at an average amount. Due to the conservative nature of CCSD's budgeting practices, budgeted expenditures may exceed budgeted revenues in a given fiscal year, resulting in a forecasted usage of fund balance.

**EXECUTIVE SUMMARY
COBB COUNTY SCHOOL DISTRICT
OTHER FUNDS FORECAST**

Fund	Beginning Fund Balance July 1, 2021	FY2022			FY2023			FY2024			FY2025			FY2026			Forecast Assumptions and Comments	
		Budget Revenue	Budget Expenditures	Ending Fund Balance June 30, 2022	Budget Revenue	Budget Expenditures	Ending Fund Balance June 30, 2023	Budget Revenue	Budget Expenditures	Ending Fund Balance June 30, 2024	Budget Revenue	Budget Expenditures	Ending Fund Balance June 30, 2025	Budget Revenue	Budget Expenditures	Ending Fund Balance June 30, 2026		
SPECIAL REVENUE FUNDS																		
Federal Aid																		
402	Title I	\$0	\$24,977,323	\$24,977,323	\$0	\$21,541,138	\$21,541,138	\$0	\$21,541,138	\$21,541,138	\$0	\$21,541,138	\$21,541,138	\$0	\$21,541,138	\$21,541,138	\$0	Grants are initially budgeted with last year amount
404	Special Education IDEA	\$0	\$27,939,790	\$27,939,790	\$0	\$21,945,218	\$21,945,218	\$0	\$21,945,218	\$21,945,218	\$0	\$21,945,218	\$21,945,218	\$0	\$21,945,218	\$21,945,218	\$0	Grants are initially budgeted with last year amount
406	Vocation Education CTAE	\$0	\$868,526	\$868,526	\$0	\$780,716	\$780,716	\$0	\$780,716	\$780,716	\$0	\$780,716	\$780,716	\$0	\$780,716	\$780,716	\$0	Grants are initially budgeted with last year amount
414	Title II - A	\$0	\$3,914,234	\$3,914,234	\$0	\$2,799,744	\$2,799,744	\$0	\$2,799,744	\$2,799,744	\$0	\$2,799,744	\$2,799,744	\$0	\$2,799,744	\$2,799,744	\$0	Grants are initially budgeted with last year amount
420	CARES Act	\$0	\$805,265	\$805,265	\$0	\$0	\$0	\$0	\$0	\$0	\$0	\$0	\$0	\$0	\$0	\$0	\$0	COVID 19 Relief Grant of FY2021
432	Homeless	\$0	\$709,599	\$709,599	\$0	\$83,380	\$83,380	\$0	\$83,380	\$83,380	\$0	\$83,380	\$83,380	\$0	\$83,380	\$83,380	\$0	Grants are initially budgeted with last year amount
448	American Rescue Plan Act	\$0	\$168,135,914	\$168,135,914	\$0	\$0	\$0	\$0	\$0	\$0	\$0	\$0	\$0	\$0	\$0	\$0	\$0	COVID 19 Relief Grant of FY2022
460	Title III - A	\$0	\$1,936,629	\$1,936,629	\$0	\$1,568,146	\$1,568,146	\$0	\$1,568,146	\$1,568,146	\$0	\$1,568,146	\$1,568,146	\$0	\$1,568,146	\$1,568,146	\$0	Grants are initially budgeted with last year amount
462	Title IV - B	\$0	\$4,104,479	\$4,104,479	\$0	\$2,403,073	\$2,403,073	\$0	\$2,403,073	\$2,403,073	\$0	\$2,403,073	\$2,403,073	\$0	\$2,403,073	\$2,403,073	\$0	Grants are initially budgeted with last year amount
478	USDA Fruit & Vegetable	\$0	\$183,211	\$183,211	\$0	\$183,211	\$183,211	\$0	\$183,211	\$183,211	\$0	\$183,211	\$183,211	\$0	\$183,211	\$183,211	\$0	Grants are initially budgeted with last year amount
600	School Nutrition	\$5,693,961	\$62,783,010	\$59,998,771	\$8,478,200	\$58,345,000	\$62,859,167	\$3,964,033	\$58,345,000	\$62,859,167	(\$550,134)	\$58,345,000	\$62,859,167	(\$5,064,301)	\$58,345,000	\$62,859,167	(\$9,578,468) *	Pending on Federal COVID rescue fund amount Project using 0% Student Growth
Special Programs																		
549	Donations	\$939,188	\$240,161	\$1,179,450	(\$101)	\$0	\$0	(\$101)	\$0	\$0	(\$101)	\$0	\$0	(\$101)	\$0	\$0	(\$101)	Donations are budgeted as received
550	Venue Management	\$466,101	\$823,809	\$908,809	\$381,101	\$1,500,000	\$1,500,000	\$381,101	\$1,500,000	\$1,500,000	\$381,101	\$1,500,000	\$1,500,000	\$381,101	\$1,500,000	\$1,500,000	\$381,101	Continue FY2023 Budget (balanced)
551	After School Program	\$2,152,420	\$7,814,902	\$8,504,634	\$1,462,688	\$10,774,828	\$10,774,828	\$1,462,688	\$10,774,828	\$10,774,828	\$1,462,688	\$10,774,828	\$10,774,828	\$1,462,688	\$10,774,828	\$10,774,828	\$1,462,688	Project using 0% Student Growth
552	Performing Arts	\$369,830	\$420,177	\$420,177	\$369,830	\$422,760	\$422,760	\$369,830	\$422,760	\$422,760	\$369,830	\$422,760	\$422,760	\$369,830	\$422,760	\$422,760	\$369,830	Continue FY2023 Budget (balanced)
553	Tuition School	\$2,250,317	\$1,399,702	\$1,399,702	\$2,250,317	\$1,399,702	\$1,399,702	\$2,250,317	\$1,399,702	\$1,399,702	\$2,250,317	\$1,399,702	\$1,399,702	\$2,250,317	\$1,399,702	\$1,399,702	\$2,250,317	Continue FY2023 Budget (balanced)
554	Public Safety	\$69,518	\$1,940,865	\$1,940,865	\$69,518	\$1,940,865	\$1,940,865	\$69,518	\$1,940,865	\$1,940,865	\$69,518	\$1,940,865	\$1,940,865	\$69,518	\$1,940,865	\$1,940,865	\$69,518	Continue FY2023 Budget (balanced)
556	Adult High School	\$425,008	\$300,470	\$300,470	\$425,008	\$300,470	\$300,470	\$425,008	\$300,470	\$300,470	\$425,008	\$300,470	\$300,470	\$425,008	\$300,470	\$300,470	\$425,008	Continue FY2023 Budget (balanced)
557	Art Career & Cultural Explore	\$16,325	\$2,600	\$2,600	\$16,325	\$2,600	\$2,600	\$16,325	\$2,600	\$2,600	\$16,325	\$2,600	\$2,600	\$16,325	\$2,600	\$2,600	\$16,325	Continue FY2023 Budget (balanced)
580	Miscellaneous Grants	\$158,803	\$390,535	\$390,535	\$158,803	\$145,000	\$145,000	\$158,803	\$145,000	\$145,000	\$158,803	\$145,000	\$145,000	\$158,803	\$145,000	\$145,000	\$158,803	Misc grants are budgeted as received
State Aid																		
510	Adult Education	\$0	\$1,236,800	\$1,236,800	\$0	\$1,164,700	\$1,164,700	\$0	\$1,164,700	\$1,164,700	\$0	\$1,164,700	\$1,164,700	\$0	\$1,164,700	\$1,164,700	\$0	Grants are initially budgeted using last year's
532	GNETS	\$182,931	\$4,143,934	\$4,143,934	\$182,931	\$3,839,122	\$3,839,122	\$182,931	\$3,839,122	\$3,839,122	\$182,931	\$3,839,122	\$3,839,122	\$182,931	\$3,839,122	\$3,839,122	\$182,931	Project using 0% Student Growth
560	Pre-Kindergarten (Lottery)	\$0	\$309,982	\$309,982	\$0	\$378,944	\$378,944	\$0	\$378,944	\$378,944	\$0	\$378,944	\$378,944	\$0	\$378,944	\$378,944	\$0	Continue FY2023 Budget (balanced)
TOTAL OF SPECIAL REVENUE FUNDS		\$12,724,402	\$315,381,917	\$314,311,699	\$13,794,620	\$131,518,617	\$136,032,784	\$9,280,453	\$131,518,617	\$136,032,784	\$4,766,286	\$131,518,617	\$136,032,784	\$252,119	\$131,518,617	\$136,032,784	(\$4,262,048)	
DEBT SERVICE FUND																		
200	Debt Service	\$0	\$0	\$0	\$0	\$0	\$0	\$0	\$0	\$0	\$0	\$0	\$0	\$0	\$0	\$0	\$0	<u>Debt Payoff Comment</u> School District Bonded Debt was paid off FY2007
INTERNAL SERVICE FUNDS																		
691	Unemployment	\$6,431	\$300,000	\$300,000	\$6,431	\$300,000	\$300,000	\$6,431	\$300,000	\$300,000	\$6,431	\$300,000	\$300,000	\$6,431	\$300,000	\$300,000	\$6,431	Continue FY2023 Budget (balanced)
692	Self Insurance	\$6,841,829	\$6,150,765	\$7,204,189	\$5,788,405	\$6,150,765	\$6,150,765	\$5,788,405	\$6,150,765	\$6,150,765	\$5,788,405	\$6,150,765	\$6,150,765	\$5,788,405	\$6,150,765	\$6,150,765	\$5,788,405	Continue FY2023 Budget (balanced)
693	FNS Catered Food Services	\$17,722	\$70,000	\$70,000	\$17,722	\$24,000	\$24,000	\$17,722	\$24,000	\$24,000	\$17,722	\$24,000	\$24,000	\$17,722	\$24,000	\$24,000	\$17,722	Continue FY2023 Budget (balanced)
TOTAL OF INTERNAL SERVICE FUND		\$6,865,982	\$6,520,765	\$7,574,189	\$5,812,558	\$6,474,765	\$6,474,765	\$5,812,558	\$6,474,765	\$6,474,765	\$5,812,558	\$6,474,765	\$6,474,765	\$5,812,558	\$6,474,765	\$6,474,765	\$5,812,558	
CAPITAL PROJECTS FUNDS																		
	SPLOST and District-Wide	\$41,847,843	\$204,127,207	\$129,462,021	\$116,513,029	\$161,674,343	\$124,598,996	\$153,588,376	\$152,169,440	\$135,275,478	\$170,482,338	\$173,456,855	\$136,305,241	\$207,633,952	\$177,795,061	\$135,029,804	\$250,399,209	
TOTAL OF CAPITAL PROJECT FUNDS		\$41,847,843	\$204,127,207	\$129,462,021	\$116,513,029	\$161,674,343	\$124,598,996	\$153,588,376	\$152,169,440	\$135,275,478	\$170,482,338	\$173,456,855	\$136,305,241	\$207,633,952	\$177,795,061	\$135,029,804	\$250,399,209	
TOTAL OF OTHER FUNDS		\$61,438,227	\$526,029,889	\$451,347,909	\$136,120,207	\$299,667,725	\$267,106,545	\$168,681,387	\$290,162,822	\$277,783,027	\$181,061,182	\$311,450,237	\$278,812,790	\$213,698,629	\$315,788,443	\$277,537,353	\$251,949,719	

Note: The Georgia Legislature passed a law allowing school districts to establish a one-cent sales tax that would be used for capital projects or debt retirement. The passage of this sales tax assists the school district in building new schools, supplying additional classrooms and equipment and technology needs of a growing school district. Cobb County Citizens voted to approve SPLOST 1 (1999-2003), SPLOST 2 (2004-2008), SPLOST 3 (2009-2013), SPLOST 4 (2014-2018), SPLOST 5 (2019-2023), SPLOST 6 (2024-2028). SPLOST 5 was approved on March 21, 2017 for another five year plan starting from January 1, 2019, ends on December 31, 2023. SPLOST 6 was approved on November 2, 2021 for another five year plan starting from January 1, 2024, ends on December 31, 2028. SPLOST 5 Tax Revenue Forecast is presented on the next page.



**COBB COUNTY SCHOOL DISTRICT
SPECIAL PURPOSE LOCAL OPTION SALES TAX REVENUES**

	2019	2020	2021	2022	2023	2024
Jan		15,102,258	15,328,660	15,601,300	15,880,696	16,137,960
Feb	11,448,617	11,691,230	11,866,495	12,077,557	12,293,848	
March	11,862,832	12,114,222	12,295,829	12,514,527	12,738,643	
April	12,808,680	13,045,759	13,257,231	13,496,132	13,729,586	
May	12,534,357	12,766,359	12,973,300	13,207,086	13,435,540	
June	12,978,130	13,218,345	13,432,614	13,674,676	13,911,219	
July	12,786,570	12,992,281	13,215,435	13,456,812	13,681,375	
Aug	12,966,263	13,174,865	13,401,154	13,645,924	13,873,643	
Sept	12,790,472	12,996,246	13,219,467	13,460,918	13,685,549	
Oct	13,140,680	13,328,075	13,561,878	13,813,035	14,035,120	
Nov	12,775,751	12,957,941	13,185,252	13,429,435	13,645,351	
Dec	12,850,301	13,033,555	13,262,191	13,507,798	13,724,975	
Yr. Total	138,942,653	156,421,136	158,999,506	161,885,200	164,635,545	16,137,960
						797,022,000



CARLA JACKSON

Tax Commissioner

HEATHER WALKER

Chief Deputy

June 23, 2022

Mr. Chris Ragsdale
Superintendent
Cobb County Board of Education
PO Box 1288
Marietta, GA 30061

Dear Mr. Ragsdale:

This letter is to certify the 2022 School Digest as follows:

Net M & O Digest	
Real Property	\$31,676,677,845
Personal Property	\$2,249,722,843
Motor Vehicle	\$181,230,170
Mobile Homes	\$12,984,231
Public Utilities	\$975,747,139
Timber 100% Value	\$15,000
Heavy Duty Equipment	\$3,336,782
Net Total	\$35,099,714,010

If you have any question, please do not hesitate to contact me.

Sincerely,

Carla Jackson
Tax Commissioner

NOTICE

The Cobb County Board of Education does hereby announce that the school district's millage rates will be set at a meeting to be held at 514 Glover Street, Marietta, Georgia in the Board Room on July 14, 2022 at 7:00 PM and pursuant to the requirements of O.C.G.A. 48-5-32, does hereby publish the following presentation of the current year's tax digest and levy, along with the history of the tax digest and levy for the past five years.

CURRENT 2022 TAX DIGEST AND 5-YEAR HISTORY OF LEVY - GENERAL FUND

<u>COUNTY SCHOOL</u>	<u>2017</u>	<u>2018</u>	<u>2019</u>	<u>2020</u>	<u>2021</u>	<u>2022</u>
Real & Personal	31,424,436,506	34,209,208,121	36,305,830,271	38,245,775,536	40,710,912,324	45,731,320,884
Motor Vehicles	583,963,950	424,772,870	332,095,090	266,071,610	210,910,680	181,230,170
Mobile Homes	12,038,537	11,963,700	12,700,651	13,109,955	13,008,126	12,984,231
Timber - 100%	73,877	117,408	0	0	0	15,000
Heavy Duty Equipment	2,281,434	1,888,857	2,277,113	2,373,911	1,799,537	3,336,782
Gross Digest	32,022,794,304	34,647,950,956	36,652,903,125	38,527,331,012	40,936,630,667	45,928,887,067
LESS M&O Exempt	(7,146,009,352)	(7,729,704,572)	(8,270,157,266)	(8,766,733,703)	(9,471,117,883)	(10,829,173,057)
Net M&O Digest	24,876,784,952	26,918,246,384	28,382,745,859	29,760,597,309	31,465,512,784	35,099,714,010
Gross M&O Millage	18.90	18.90	18.90	18.90	18.90	18.90
LESS Rollbacks						
PLUS Increases						
Net M&O Millage	18.90	18.90	18.90	18.90	18.90	18.90
Net Taxes Levied	470,171,236	508,754,857	536,433,897	562,475,289	594,698,192	663,384,595
Net Taxes \$ Increase/Decrease	28,595,608	38,583,621	27,679,040	26,041,392	32,222,902	68,686,403
Net Taxes % Increase/Decrease	6.48%	8.21%	5.44%	4.85%	5.73%	11.55%

**EXECUTIVE SUMMARY
COBB COUNTY SCHOOL DISTRICT
MILLAGE RATE TRENDS**

Metro Atlanta Millage Rate Comparison

Metro Atlanta System	General Fund Millage	Bond Millage	Total Millage	Standard Homestead Exemption
Atlanta (APS)	20.740	0.000	20.740	\$50,000
Cobb	18.900	0.000	18.900	\$10,000
Dekalb	23.080	0.000	23.080	\$12,500
Fulton	17.796	0.000	17.796	\$2,000
Gwinnett	19.700	1.650	19.700	\$4,000

Based on FY2022 (2021 Digest) millage rates adopted by Metro Atlanta school districts.

Property Tax Rates – Cobb County School District

Note: Taxes are levied on real and personal property. Based on a millage levy of 1.00 Mill, a homeowner would pay \$1.00 per \$1,000 on 40% of the assessed value.

Fiscal Year	General Fund Millage Rate	Bond Fund Millage Rate	Total Millage Rate
2003	19.00	0.90	19.90
2004	19.00	0.90	19.90
2005	19.00	0.90	19.90
2006	19.00	0.90	19.90
2007	19.00	0.90	19.90
2008	18.90	0.00	18.90
2009	18.90	0.00	18.90
2010	18.90	0.00	18.90
2011	18.90	0.00	18.90
2012	18.90	0.00	18.90
2013	18.90	0.00	18.90
2014	18.90	0.00	18.90
2015	18.90	0.00	18.90
2016	18.90	0.00	18.90
2017	18.90	0.00	18.90
2018	18.90	0.00	18.90
2019	18.90	0.00	18.90
2020	18.90	0.00	18.90
2021	18.90	0.00	18.90
2022	18.90	0.00	18.90
2023	18.90	0.00	18.90

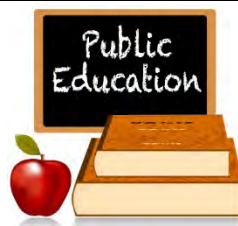

Organizational Section

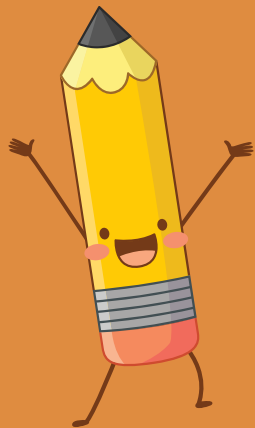

All matters relating to education and operations in the Cobb County School District are governed and controlled by the Board of Education as provided by Georgia law. The Board has the responsibility to maintain a uniform system of public schools providing quality education for all young people of Cobb County. With the advice of the superintendent, the Board must determine the policies and prescribe the rules and regulations for the management and administration of the school system.

Generally, the Board holds public meetings twice a month to conduct normal business with special sessions as needed. The Board is composed of seven members who are each elected for four years from one of seven geographical districts in the county. The Board elects a chairman and vice-chairman from the seven members to govern the body for a one year period. As of June 30, 2022, the members of the Board and their term expiration dates are as follows:

<u>Title</u>	<u>Name</u>	<u>Term Expires</u>
Chair	Mr. David Chastain	December 31, 2022
Vice-Chair	Mr. David Banks	December 31, 2024
Board Member	Mrs. Charisse Davis	December 31, 2022
Board Member	Dr. Jaha Howard	December 31, 2022
Board Member	Mr. Leroy Tre' Hutchins	December 31, 2024
Board Member	Mr. Randy Scamihorn	December 31, 2024
Board Member	Mr. Brad Wheeler	December 31, 2024

**COBB COUNTY SCHOOL DISTRICT
ELECTED OFFICIALS AND SUPERINTENDENT OF SCHOOLS
JUNE 30, 2022**



**RANDY
SCAMIHORN**

POST 1

10 Years Served



**DR. JAHA
HOWARD**

POST 2

4 Years Served



**LEROY TRE'
HUTCHINS**

POST 3

2 Years Served



**DAVID
CHASTAIN**

POST 4

8 Years Served

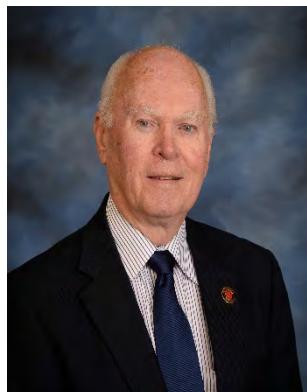

DAVID BANKS

POST 5

14 Years Served



CHARISSE DAVIS

POST 6

4 Years Served



BRAD WHEELER

POST 7

10 Years Served



CHRIS RAGSDALE

SUPERINTENDENT

COBB COUNTY SCHOOL DISTRICT SCHOOL BOARD POST AREAS

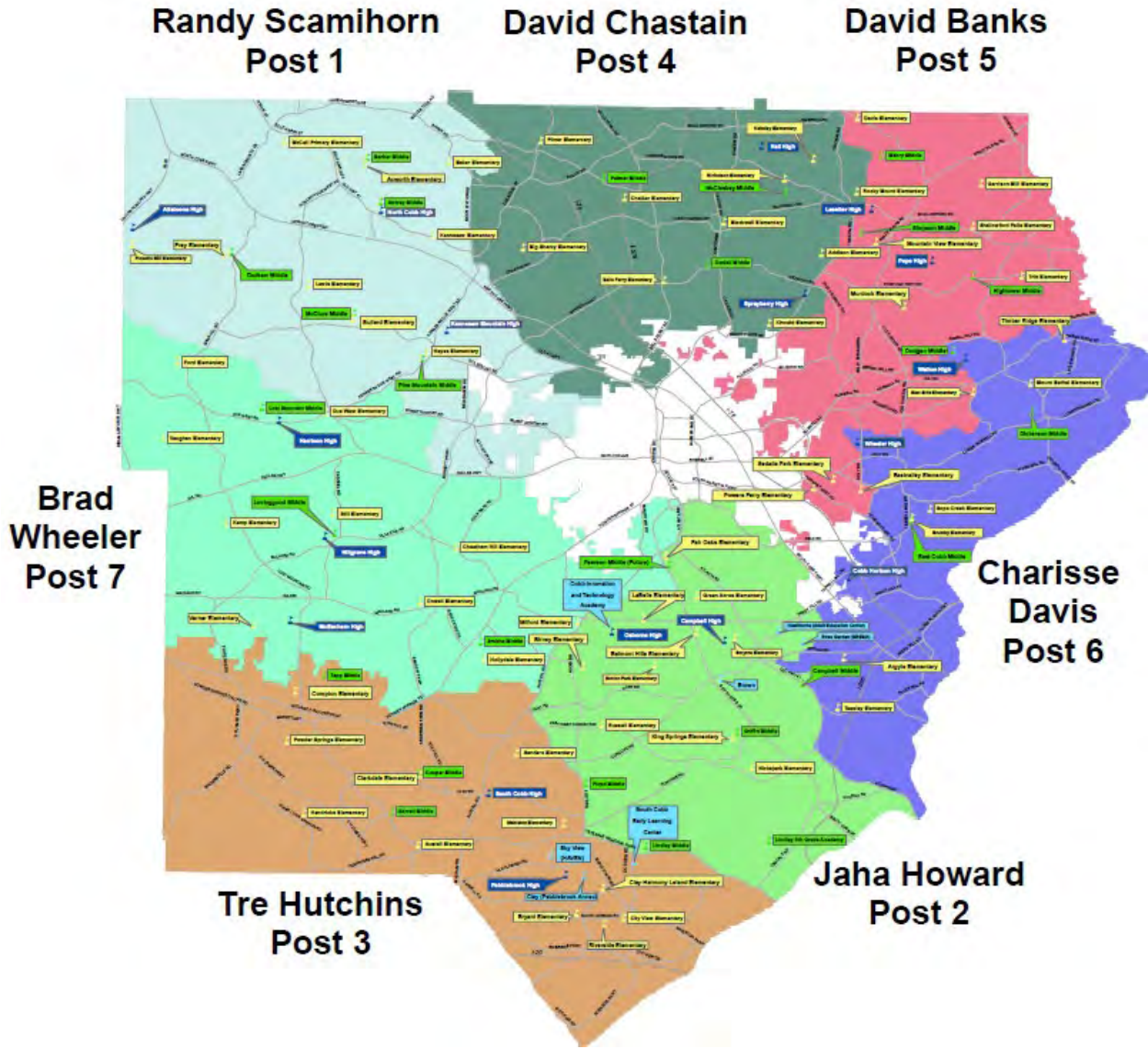

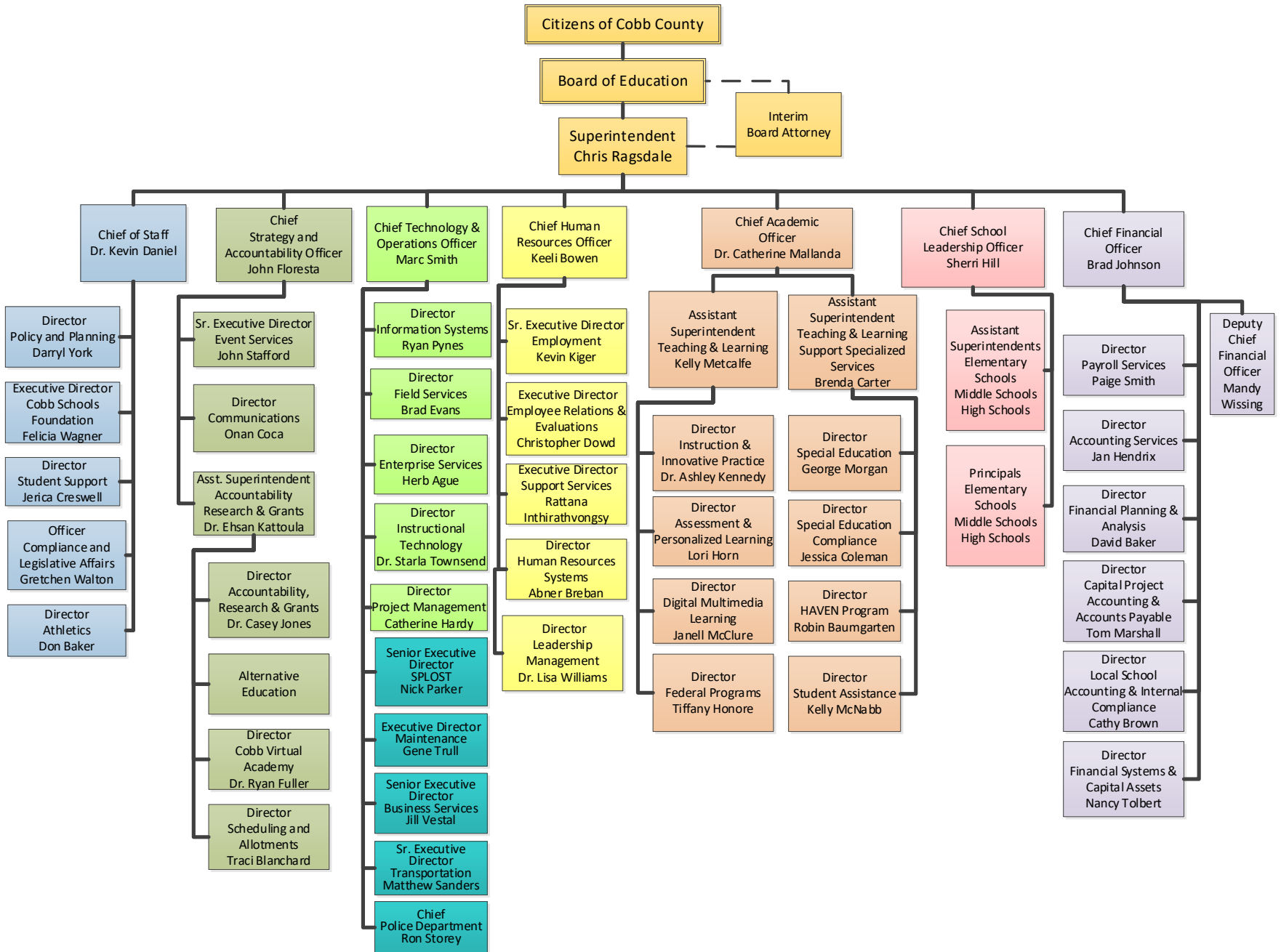

COBB COUNTY SCHOOL DISTRICT SCHOOL DISTRICT ENTITY

Cobb County School District

The Cobb County School District is the 2nd largest school system in Georgia and the 25th largest in the United States. Our student population is approximately 107,000. The purpose and responsibility of the District is to provide a thorough and efficient educational system for the children enrolled in public schools within its boundaries whereby each child has access to programs and services that are appropriate to his or her educational needs.

We strive to maintain a positive, purposeful, and active relationship with the families of our students, and with the wider community in which we operate. We do this by working with the Parent Teacher Association (PTA), the Cobb Chamber of Commerce, civic organizations, local school councils, and other groups to build the community support vital to the success of our schools.

In partnership with the Cobb Chamber of Commerce, local businesses and organizations are paired with Cobb County schools to provide volunteer support, extra funding or unique services matched to individual school needs.

With approximately 14,000 full-time employees including over 8,700 classroom teachers and 3,500 school personnel in the General Fund, the School District is the largest employer in Cobb County. Salaries range from \$52,970 for a beginning teacher with a bachelor's degree to \$111,612 for a teacher with 30 years of experience and a doctorate degree.

Board of Education and Administration

The Cobb County Public School District is the basic unit of governmental organization established to provide educational services to the citizens of Cobb County, Georgia, excluding the city of Marietta which operates its own school district. By Article VIII, Section V, Paragraph 1, of the Constitution of the State of Georgia, "authority is granted to counties to establish and maintain public schools within their limits." Under this legal provision, the Cobb County Schools are operated.

The school district functions under the regulation of the State Board of Education of Georgia and the State Department of Education. From these sources come standards for all educational services of the School District. Through a network of regulations and services, the State Board and the State Department of Education assist Cobb County and other Georgia school systems in the educational process at the local level.

The Georgia Constitution requires that an elected board of education oversee each public school system. Those Boards of Education are elected by the public and are accountable to the public for the fiduciary and stewardship responsibility of the wise use of public funds and public trust.

The Cobb County Board of Education is composed of seven members who are elected to four-year staggered terms in individual posts. The Chairman and Vice Chairman of the Board are elected by a majority of the Board and serve one-year terms. Mr. Chris Ragsdale currently serves as the Superintendent of the District. The first recorded minutes of a governing board of

COBB COUNTY SCHOOL DISTRICT SCHOOL DISTRICT ENTITY (Continued)

schools in Cobb County is dated June 7, 1881. In that year, the schools were operated on an income of less than \$5,000. From this modest beginning we have developed an educational enterprise including 112 schools serving approximately 107,000 students with a total annual budget of \$1.5 billion in all funds.

The Board is mandated by the State of Georgia with responsibilities to establish general policies, approve expenditures, set the tax rate for local school funds, approve personnel appointments, make decisions on school sites and construction and appoint special consultants.

These governing powers are singularly vested in the Cobb County Board of Education (Board) and may not be delegated to others. However, the responsibility for the successful supervision and management of the educational and operational functions of the Cobb County School District (District) is delegated (conferred) to the Superintendent, who shall serve as the Chief Executive Officer (CEO) of the District on behalf of the Board. The Superintendent and eight administrative divisions: Academics, Accountability & Research, Leadership, Operational Support, Technology Services, Chief of Staff, Human Resources, and Financial Services are responsible for the administration of the School District, but final responsibility rests with the Board.

A strong concern for, and support of, education has long been a tradition of Cobb citizens. This concern has been paralleled by the quality and enthusiasm of the professional educators who work in the school system. The cooperation between local citizens and educators that has marked the success of education in Cobb County in the past will continue to increase educational opportunities for young people in the coming years.



COBB COUNTY SCHOOL DISTRICT ABOUT THE DISTRICT

112 Schools

Elementary Schools – 66
 Middle Schools - 26
 High Schools - 17
 Special Education Centers – 1
 Early Learning Center– 1
 Adult Education Center - 1



Employees: 17,000+

CCSD is the Largest Employer in Cobb County (All Funds)

Enrollment: 107,000+

White 34.4%
 Black 30.2%
 Hispanic 24.4%
 Asian 5.8%
 Multi-Racial 4.5%
 American Indian < 1%
 Pacific Islander < 1%



CCSD Operational and Financial Credit Ratings

Aaa	Long-Term Rating	Standard & Poor's
A-1	Short Term Rating	Standard & Poor's
AAA	Long-Term Rating	Moody's
MIG1	Short-Term Rating	Moody's
AAA	Long-Term Rating	Kroll Bond Rating
K1+	Short Term Rating	Kroll Bond Rating



Mission & Goal

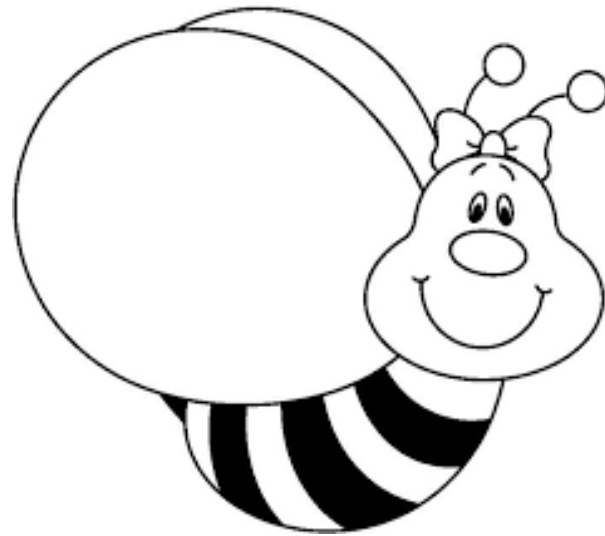

**COBB COUNTY SCHOOL DISTRICT
DISTRICT MISSION STATEMENT**



One Team. One Goal: Student Success.

**COBB COUNTY SCHOOL DISTRICT
DISTRICT CORE VALUES, BELIEFS AND GOALS**

Our Core Values, Beliefs, and Goals

Our Core Values

Achievement - aspiring to the highest level of excellence

Integrity - demonstrating honesty, consistency, taking responsibility for action, being worthy of trust

Creativity/Innovation - supporting flexibility, adaptability in keeping up with changes in education and technology

Accountability - taking responsibility for actions, outcomes, and expectations

Our Beliefs

We believe successful schools are a foundation of community stability, growth, and prosperity.

We believe family and community engagement is critical to student and district success.

We believe in a constant and purposeful focus on what is best for students.

We believe creativity and innovation are encouraged and embraced by all stakeholders.

We believe in cultivating a positive environment where students are provided pathways for success.

Our Goals

Vary learning experiences to increase success in career paths.

Differentiate resources for areas/schools based on needs.

Develop stakeholder involvement to promote student success.

Recruit, hire, support, and retain employees for the highest levels of excellence.



District Direction for Continuous Improvement

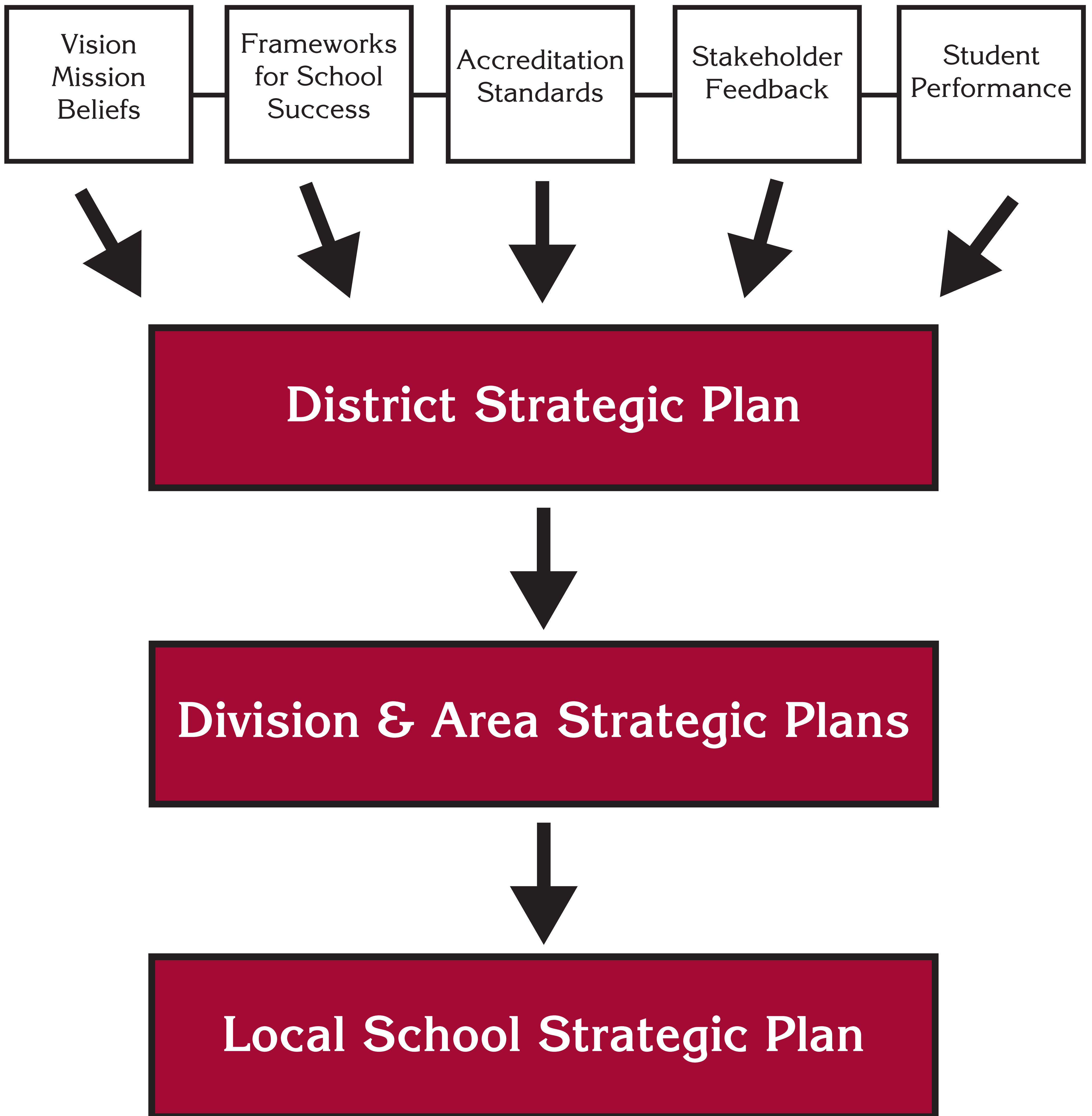

Pay for Priorities



**COBB COUNTY SCHOOL DISTRICT
NUMBER OF PERSONNEL AND RATIO OF PUPILS TO PROFESSIONAL PERSONNEL
LAST TEN FISCAL YEARS**

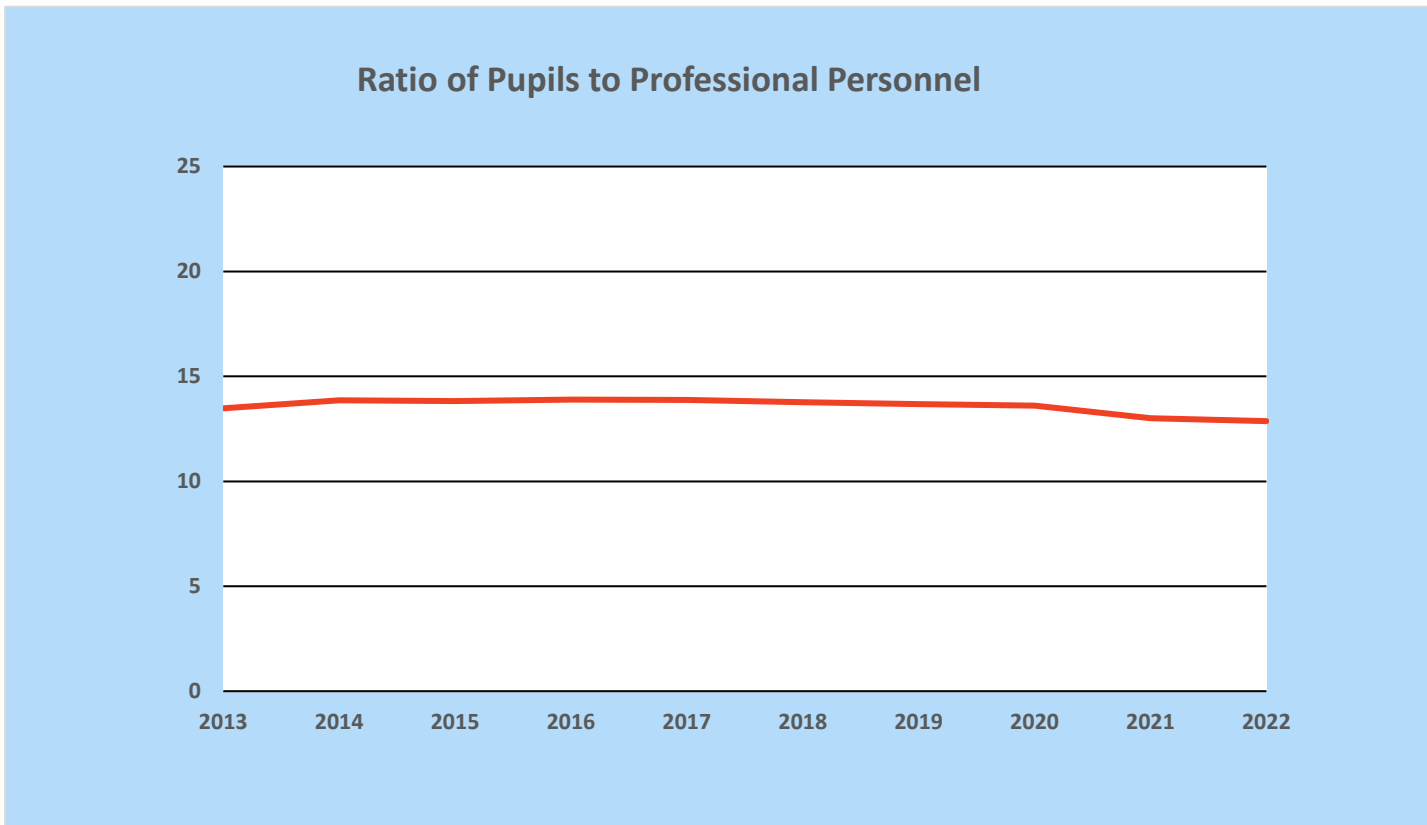

Fiscal Year	Professional Personnel (a)	Other Operating Personnel (b)	Service Personnel (c)	Total Personnel	Active Student Enrollment	Ratio of Pupils to Professional Personnel
2013	8,008	2,896	2,813	13,717	107,914	13.5
2014	7,907	2,821	2,834	13,562	109,529	13.9
2015	8,036	2,769	2,949	13,754	111,060	13.8
2016	8,050	2,943	2,599	13,592	111,848	13.9
2017	8,099	2,953	2,613	13,665	112,412	13.9
2018	8,092	2,587	2,927	13,606	111,482	13.8
2019	8,141	2,604	2,895	13,640	111,386	13.7
2020	8,217	2,932	2,632	13,781	111,760	13.6
2021	8,224	2,888	2,417	13,529	106,983	13.0
2022	8,284	2,872	2,328	13,484	106,601	12.9

(a) Professional personnel consists of all certified personnel including teachers, librarians, counselors, supervisors, consultants, coordinators, principals, assistant principals, and other leadership personnel.

(b) Other operating personnel includes non-certified leadership personnel, classroom aides, secretarial and clerical employees, and other technicians.

(c) Service personnel includes food service personnel, custodial employees, bus drivers, and maintenance/warehouse employees.

Source: District Records

**COBB COUNTY SCHOOL DISTRICT
OPERATING STATISTICS
LAST TEN FISCAL YEARS**

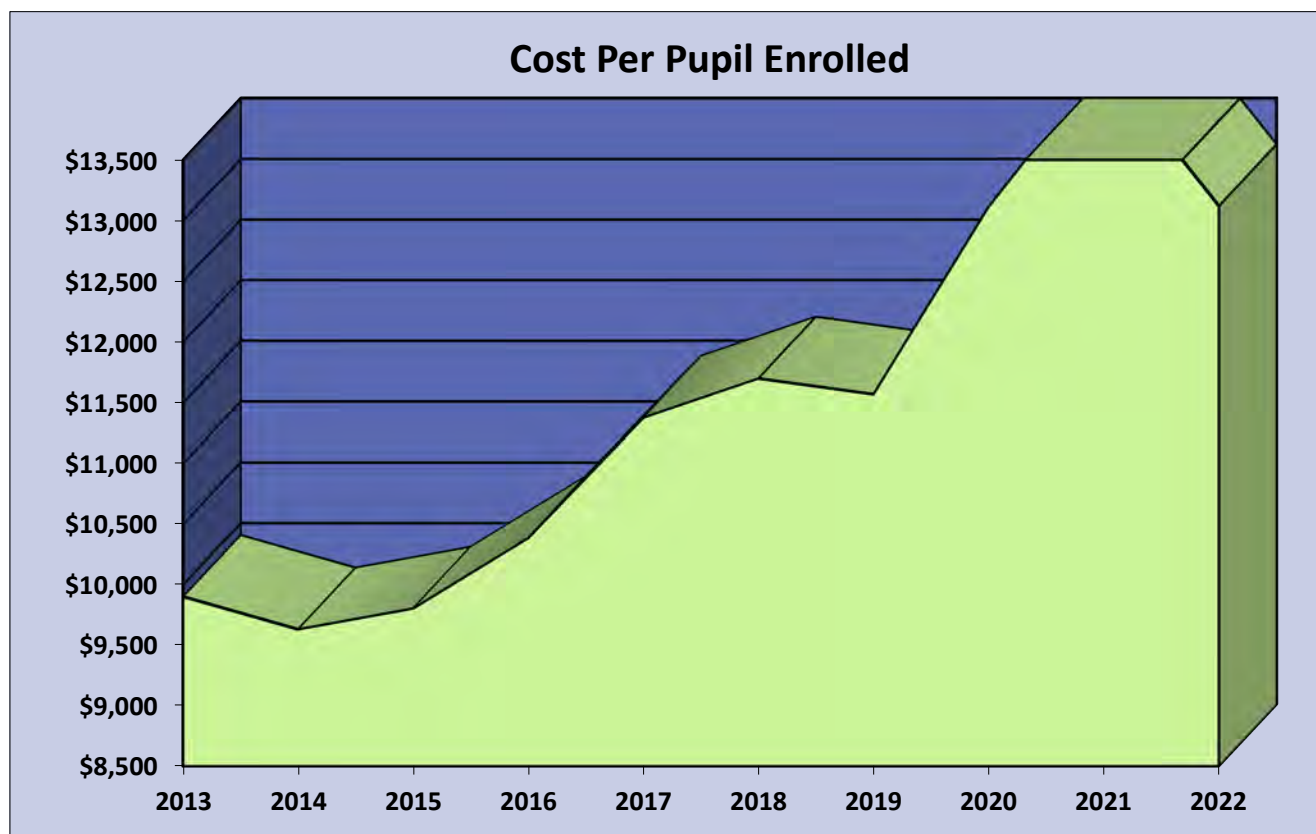

Fiscal Year	Active Student Enrollment	Cost Per Pupil Enrolled	Percentage of Change	Professional Personnel	Ratio of Pupils to Professional Personnel
2013	107,914	9,901	1.83%	8,008	13.5
2014	109,529	9,631	-2.73%	7,907	13.9
2015	111,060	9,803	1.79%	8,036	13.8
2016	111,848	10,385	5.94%	8,050	13.9
2017	112,412	11,373	9.52%	8,099	13.9
2018	111,482	11,696	2.84%	8,092	13.8
2019	111,386	11,566	-1.11%	8,141	13.7
2020	111,760	13,113	13.37%	8,217	13.6
2021	106,983	14,314	9.16%	8,224	13.0
2022	106,601	13,121	-8.34%	8,284	12.9

Note: Professional personnel consists of all certified personnel including teachers, librarians, counselors, supervisors consultants, coordinators, principals, assistant principals and other leadership personnel.

Source: District Records

**COMPARISON OF COBB AND STATE TEACHER SALARY
FY2022 - FY2023**

COBB STEP	STATE STEP	COBB CIT4	STATE T-4	Local Supplement	% Higher than State	COBB CIT5	STATE T-5	Local Supplement	% Higher than State	COBB CIT6	STATE T-6	Local Supplement	% Higher than State	COBB CIT7	STATE T-7	Local Supplement	% Higher than State
1-3	E	52,970	39,092	13,878	35.5%	58,568	44,206	14,362	32.5%	65,657	49,303	16,354	33.2%	72,559	54,176	18,383	33.9%
4	1	54,765	40,115	14,650	36.5%	60,327	45,382	14,945	32.9%	67,625	50,632	16,993	33.6%	74,737	55,651	19,086	34.3%
5	2	55,442	41,168	14,274	34.7%	62,316	46,593	15,723	33.7%	70,420	52,001	18,419	35.4%	78,165	57,171	20,994	36.7%
6	3	56,380	42,253	14,127	33.4%	64,184	47,841	16,343	34.2%	72,531	53,411	19,120	35.8%	80,511	58,736	21,775	37.1%
7	4	58,632	43,743	14,889	34.0%	66,556	49,555	17,001	34.3%	74,804	55,347	19,457	35.2%	83,035	60,885	22,150	36.4%
8	5	60,394	44,905	15,489	34.5%	68,552	50,892	17,660	34.7%	77,049	56,857	20,192	35.5%	85,525	62,562	22,963	36.7%
9	6	63,112	46,701	16,411	35.1%	71,640	52,957	18,683	35.3%	80,309	59,191	21,118	35.7%	88,754	65,152	23,602	36.2%
10-11	7	65,003	47,952	17,051	35.6%	73,789	54,396	19,393	35.7%	82,717	60,817	21,900	36.0%	91,415	66,957	24,458	36.5%
12-13	L1	66,951	49,241	17,710	36.0%	76,003	55,878	20,125	36.0%	85,202	62,492	22,710	36.3%	94,156	68,816	25,340	36.8%
14-15	L2	68,961	50,568	18,393	36.4%	78,284	57,404	20,880	36.4%	87,755	64,217	23,538	36.7%	96,983	70,730	26,253	37.1%
16-17	L3	71,030	51,935	19,095	36.8%	80,632	58,976	21,656	36.7%	90,387	65,994	24,393	37.0%	99,891	72,702	27,189	37.4%
18-19	L4	73,164	53,343	19,821	37.2%	83,050	60,595	22,455	37.1%	93,100	67,824	25,276	37.3%	102,888	74,733	28,155	37.7%
20-21	L5	75,600	54,793	20,807	38.0%	85,825	62,263	23,562	37.8%	96,220	69,709	26,511	38.0%	106,340	76,825	29,515	38.4%
22-23	L6	77,530	56,287	21,243	37.7%	88,057	63,981	24,076	37.6%	98,744	71,650	27,094	37.8%	109,145	78,980	30,165	38.2%
24-26	L6	78,168	56,287	21,881	38.9%	88,723	63,981	24,742	38.7%	99,481	71,650	27,831	38.8%	109,946	78,980	30,966	39.2%
27-29	L6	78,816	56,287	22,529	40.0%	89,431	63,981	25,450	39.8%	100,222	71,650	28,572	39.9%	110,767	78,980	31,787	40.2%
30+	L6	79,483	56,287	23,196	41.2%	90,170	63,981	26,189	40.9%	101,023	71,650	29,373	41.0%	111,612	78,980	32,632	41.3%

Cobb - Scale up 8.5% (Salary raise plus Full Salary Step Increase)

State - Scale up \$2,000 from FY2022

IMPROVEMENT OPPORTUNITIES IN THE BUDGET PLANNING PROCESS

FINDING EFFICIENCIES

Cobb County School District sees a direct connection between success through continuous improvement and the performance in efficiencies. The personnel and operational expenditure adjustments are included in the annual budget process. The evaluation of miscellaneous expenditures allows the District to focus on its core business - educating students - successfully and without waste. Even the smallest efficiencies are identified and adjusted in the budget. The following efficiencies were identified and adjusted as part of the FY2023 Budget.



Highlight of FY2023 Efficiency Identification on Position and Expenditure Adjustments

Position Enhancement Costs	
Add School Psychologists	\$1.3M
Add Custodians for Square Footage	\$0.3M
Reinstate Library Media Parapro	\$0.5M
Upgrade Elementary School Clerks	\$0.8M
Salary Adjustments	
8.5%-13.1% Raise for all Non-Temp employees (Depending on Salary Step Eligibility)	\$86.7M
Miscellaneous Expenditure Adjustments	
Expenditure Adj Utilities	\$1.5M
Expenditure Adj Operational /Safety	\$1.6M

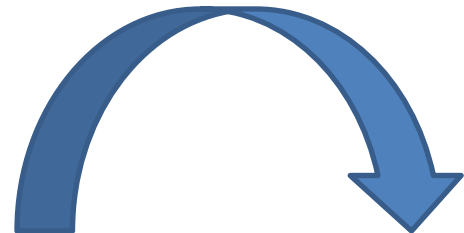

Position Pool Adjustment	
Position Pool Adj to Accommodate the Pandemic Decrease in Students	(\$6.9M)
Miscellaneous Expenditure Adjustments	
Adj Budget for Revenue Estimates: Cell Towers, MedACE, Medicaid & Grants	(\$0.7M)
Supply Allotment/Workdays	(\$0.4M)

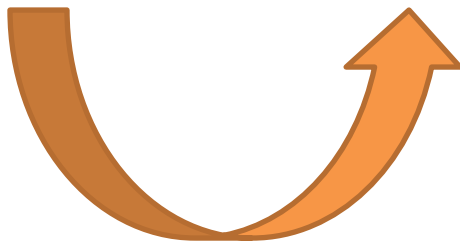

Policy, Procedure, & Process



PLANNING, PROGRAMMING, BUDGETING SYSTEM
(Policy Index DB)

The Cobb County Board of Education (Board) shall annually adopt a budget according to the laws of the State of Georgia and the regulations of the State Board of Education. The budget shall be adopted at a public meeting of the Board.

Furthermore, the Board expects the Superintendent to assure that the Cobb County School District (District) maintains a multi-year financial plan and to establish financial guidelines and procedures that:

- Protect the District's fiscal soundness; and
- Support the fulfillment of the District's priorities.

A. FINANCIAL PLANNING:

1. The District will prepare a one year preliminary General Fund Budget forecast of projected revenues and projected expenditure appropriations on an annual basis. Financial planning for any fiscal year, or the remaining part of any fiscal year, will:
 - a. Clearly and directly support the District's priorities as established in the District Strategic Plan in response to student achievement data and by Board Policy DA (Fiscal Management Goals and Objectives);
 - b. Ensure the District's fiscal soundness;
 - c. Support the fulfillment of the District's multi-year financial plan;
 - d. Fulfill the requirements of Board Policy DI (Accounting and Reporting);
 - e. Contain sufficient information to enable credible projections of revenues and expenses;
 - f. Disclose planning assumptions for the General Fund.

2. Multi-Year Financial Plan:

The District will prepare a five year General Fund Budget forecast of projected revenues and projected expenditure appropriations on an annual basis. This multi-year financial plan shall:

- a. Include a total projected obligation and cost of multi-year programs; and
- b. Be updated whenever significant change occurs.

B. BUDGET DEVELOPMENT:

1. General Provisions:

a. Revenue:

Each General Fund revenue account shall be analyzed during the budget development process to develop reasonable budget assumptions, projections, and detailed documentation for each revenue account category.

b. Expenditure Appropriations:

- (1) Position counts will be calculated by Division and classification based on Local School Allocation Formulas and a continuation of prior year positions in school support departments.
- (2) Proposals for incremental budget appropriation increases or decreases shall be presented to the Superintendent annually for consideration in the budget development process.

PLANNING, PROGRAMMING, BUDGETING SYSTEM (continued)

c. General Budget Development Methodology:

- (1) The budget will be developed utilizing a structural balanced budget philosophy where recurring revenue equals recurring expenditure appropriations. If one time funds are used from fund balance to assist in balancing the General Fund budget, the expenditure appropriations associated with those one time funds shall be identified as part of the budget approval process and the Board will identify recurring funds for these expenditure appropriations in the immediate subsequent budget development year. The Board shall maintain the objective to keep the General Fund reserve at a level of at least 8.33% (One Month Reserve) of General Fund Expenditure Appropriations.
- (2) The budget will be developed utilizing a Budget Calendar where each budget event is identified along with a person responsible for completion of that event.
- (3) All budget development budget calculations shall be presented along with assumptions utilized in projecting budget estimates.

2. Budget Development Process:

- a. The District will utilize an annual budgeting process that includes:
 - (1) A credible projection of revenues and expenses;
 - (2) Separation of capital and operational items;
 - (3) Cash flow;
 - (4) Disclosure of planning assumptions upon which District leadership based its planning;
 - (5) Total projected obligation and cost of new and proposed multi-year programs; and
 - (6) Annual and remaining obligation and cost of existing multi-year programs.
- b. As part of the budget adoption process, the Superintendent will present to the Board of Education and make public those budget items pre-approved by the Board from specific approval in the spending authority of the Superintendent. (see Board Policy DI ([Accounting and Reporting])).
- c. The District shall not create long-term obligations of employment, compensation, or benefits for employees, consultants, contract workers or volunteers, that extend beyond reliable revenue projections.
- d. The District shall not treat Board approved budget adjustments during the fiscal year as carry-overs to be included in the initial budget amount for the subsequent fiscal year. Rather, the subsequent fiscal year budget process shall:
 - (1) Identify both the original amount included in the current year budget and the amount of any adjustment approved by the Board during the current fiscal year; and
 - (2) Identify adjustments needed for recurring expenses as budget enhancements in the subsequent fiscal year budget process.
- e. **General Fund Budget Development Events:**
 - (1) Administration will develop an annual Budget Forecast for Revenues and Expenditure Appropriations.
 - (2) Administration will develop a Budget Calendar.
 - (3) Administration will seek budget input from the Board of Education.
 - (4) Administration will prepare a tentative, balanced budget for consideration by the Board of Education prior to the Board's review of the budget.

PLANNING, PROGRAMMING, BUDGETING SYSTEM (continued)

(5) The Board will conduct budget meetings as necessary to review and finalize the tentative, balanced budget.

(6) The Board will approve the Budget before June 30 each year.

f. Continuing Budget Management:

(1) All General Fund, fund balanced budget adjustments must be approved by the Board during the fiscal year of July 1 through June 30.

(2) Administration shall provide financial and budget information as requested by the Board during the fiscal year.

3. Public Notice:

a. Advertisement:

The Board shall advertise at least one time in a newspaper of general circulation in Cobb County the proposed budget for each fiscal year. The advertisement shall be made prior to the meeting of the Board of Education at which the District budget for the fiscal year is to be finally adopted and shall follow the form required by the State Board of Education.

b. Hearings:

Before the budget is officially adopted, the Board shall hold a public hearing to explain the proposed budget and invite questions and discussion from the administration and public relative to the budget.

4. Millage Rate:

a. The Board shall annually recommend to the County Commissioners the tax millage for the county to be collected for school purposes only and in compliance with Article 8, Section 6, Paragraph I(a), of the Georgia Constitution which provides that the millage rate shall not be greater than 20 mills.

b. The Board shall approve the General Fund millage rate annually by July 1 and shall conduct millage rate hearings as required by State of Georgia law.



LOCAL TAX REVENUES (Policy Index DFA)

Tax Allocation Districts

The Georgia Redevelopment Powers Law, O.C.G.A. § 36-44-1, et seq., provides means for the redevelopment of economically and socially depressed areas through the creation of tax allocation districts by political subdivisions. O.C.G.A. § 36-44-8. The creation of a tax allocation district (TAD) permits the use of actual or anticipated increase in ad valorem tax revenues resulting from redevelopment activities to fund activities in furtherance of that redevelopment. Implicit in this financing method (which involves a commitment of public resources to what are generally private endeavors) is the expectation that but for the infusion of the public commitment, the increased property tax revenue would not occur.

Typically, a large proportion of the total tax millage rate for a county is levied for county school district purposes. The Georgia Constitution and the Redevelopment Powers Law provides that the school district component of tax revenue can be included in the computation of tax allocation increments if the board of education consents to such inclusion by resolution duly adopted by the board.

The Cobb County Board of Education (Board) has a fiduciary obligation of the highest order to ensure that the Cobb County School District (District) component of ad valorem property tax levies is used in a manner that is clearly and convincingly beneficial to the District and its students. This Statement of Policy is intended to permit the District to support appropriate redevelopment under the Redevelopment Powers Law without detriment to the constitutional mission of education.

A. GENERAL PROVISIONS:

The Board shall:

1. Carefully and fully consider all applications for participation in a tax allocation district (TAD) requiring consent of the Board under O.C.G.A. § 36-44-9(c);
2. Not consent to the creation of a (TAD) unless, following careful review of the application, the evidence is clear and convincing that:
 - a. The redevelopment activities described in the redevelopment plan will occur;
 - b. But for the use of TAD financing, the redevelopment activity and tax increment would not occur; and
 - c. The redevelopment activities will provide benefits to the District commensurate with the dedication of the District component of the tax increment ("district benefit").
3. "District benefit" shall mean additional revenues resulting from a TAD that would otherwise be received by the District (with or without regard to the existence of the TAD) are ultimately received or restored to the District within a time and under terms and conditions set forth in the consent documents or, if not, such other benefits as would warrant any deferral or adjustment of receipt of increased tax revenues resulting from the TAD;
4. Look with significantly greater favor upon applications for consent that involve specific projects, defined as projects with detailed descriptions, including information as to the:
 - a. Identity of the project redevelopment participants;

LOCAL TAX REVENUES (continued)

- b. Affected real property;
 - c. Property improvements;
 - d. Redevelopment costs;
 - e. Method of financing;
 - f. Nature and status of participation and financing commitments; and
 - g. Such other information as may be required by the Board.
5. Applications that do not involve specific projects as described above shall not be approved unless the following criteria are clearly satisfied:
- a. The characteristics of the proposed district are such that the proposed described redevelopment offers unique opportunities for assured substantial increases in the assessed value of the proposed TAD;
 - b. Financial projections are detailed and supported by documented information, reliable models, and analysis from sources with recognized expertise;
 - c. There are identified special benefits, direct or indirect, for the District beyond those projected as resulting solely from the increase in assessed value of the property in the TAD;
 - d. There are sound reasons why designation of a TAD and Board consent cannot await the creation of specific projects;
 - e. The projected time frames for milestones for the redevelopment are of such length and sufficiently credible as to minimize risk to District interests;
 - f. There are safeguards in place to:
 - (1) Assure the opportunity for Board scrutiny and involvement in decisions as the redevelopment occurs, including, at a minimum, the opportunity to approve specific projects; and
 - (2) Protect the use of the Board share of accumulated tax increments pending use for redevelopment costs.

B. PROCEDURES:

- 1. The Board adopts and incorporates the current TAD Policy and Guidelines adopted by the Cobb County Board of Commissioners to the extent applicable, except as provided herein.
- 2. Applicants seeking the Board's consent to a TAD shall:
 - a. Provide the District with two copies of all materials submitted to the Cobb County government (including the required Redevelopment Plan) at the time of that submission;
 - b. Submit a completed Application for School Board Consent to a Tax Allocation District (Application) in a form prescribed by the District; and
 - c. Provide such other information required by the District.
- 3. Applications for Board consent shall be submitted no later than August 1 of the year prior to the year in which the proposed TAD is to take effect. This requirement may be waived by the Board for good cause shown.
- 4. Applicants shall be responsible for all costs and fees associated with the review of the application. Payment shall be made before the application is filed and shall be nonrefundable.
- 5. Any conditions to Board consent to a TAD shall be included in a binding intergovernmental agreement or other contract containing terms sufficient to carry out this Policy.

ACCOUNTING AND REPORTING
(Policy Index DI)

The Board of Education (Board) expects the Superintendent to assure that the Cobb County School District (District) establishes financial guidelines and procedures that comply with generally accepted accounting principles, State Department of Education rules, and District expectations established in Board Policy DB (Planning, Programming, Budgeting System).

A. PERSONNEL BUDGET:

1. To protect the mutual trust between the Board of Education, the Superintendent, and employees of the District, the Superintendent shall, in Executive Session provided that this action does not attempt to violate any provision of the Georgia Open Meetings Act, discuss all personnel budget issues including any proposed changes to the compensation/structure including proposed bonuses, pay increases, and the addition or deletion of employee groups.
2. In considering the implementation of specific personnel options (for instance the adequate staffing of a leadership academy, offering an enriched staff development program, or other improvements), the Superintendent must:
 - a. Disclose to the Board the potential financial and programmatic impact of such actions;
 - b. Identify other initiatives, including reaching target reserve levels, which may be jeopardized as a result of funding proposed personnel issues.
 - c. Require specific Board action to hire in excess of those positions provided in the budget.

B. LOANS:

1. Short-Term Loans:

- a. The District may incur indebtedness only when approved by the Board and then only in an amount specifically approved by the Board.
- b. **Procedures:**
 - (1) The Board, as it deems necessary, may vote to approve a resolution authorizing the borrowing of money for District purposes. The aggregate amount of all such loans outstanding at any one time shall not exceed 75% of the total income of the Board from taxes collected by the Board in the preceding year.
 - (2) In accordance with O.C.G.A. § 20-2-391, the resolution authorizing the borrowing of funds shall, as a minimum, state:
 - (a) The amount to be borrowed;
 - (b) The length of time it is to be used;
 - (c) The rate of interest to be paid;
 - (d) The purpose for which it is borrowed; and
 - (e) The institution from which it is to be borrowed.
 - (3) Such loans shall be payable on or before December 31 of each year.
 - (4) The Board Chair and Superintendent shall execute the note(s) for money that is authorized to be borrowed under the resolution passed by the Board (Board Policy BBA [Board Officers]) and Board Policy ABB [Board Powers and Duties]). (see O.C.G.A. § 20-2-395)

2. Loans to Schools:

a. Eligibility:

ACCOUNTING AND REPORTING (continued)

Before a loan can be made to a school, the school must demonstrate that all borrowed funds shall be used for curricular, co-curricular or extra-curricular activities which are related to an educational program.

b. **Guidelines:**

The following guidelines shall apply to loans:

- (1) Loans will be used for the purpose of assisting the program specified;
- (2) The maximum loan to a local school will not exceed \$50,000; and
- (3) Loans will be repaid within five years with one-fifth of the loan due on each anniversary of the loan date.
- (4) Loan requests should follow Financial Services procedures.

3. **Loans to Organizations other than Schools:**

The Board may not authorize a loan of District funds to private organizations, such as Booster Clubs, PTAs, or other school support organizations (Administrative Rule KG-R [Use of School Facilities]).

C. **FUND BALANCE:**

1. In accordance with Governmental Accounting Standards Board (GASB) Statement 54, the Board recognizes the following five categories of fund balances for financial reporting purposes:

- a. *Non-spendable Fund Balance* – non-cash assets such as inventories or prepaid items.
- b. *Restricted Fund Balance* – funds legally restricted for specific purposes, such as grant funds.
- c. *Committed Fund Balance* – amounts that can only be used for specific purposes pursuant to a formal vote of the Board. The Board, as the government's highest level of decision-making authority, may authorize expenditures from the committed fund balance by a formal vote prior to the District's fiscal year-end for that fiscal year. Future modification or rescission of committed funds must likewise be accomplished by a formal vote of the Board prior to fiscal year-end. A majority Board vote is required to approve a commitment and a majority Board vote is required to remove a commitment.
- d. *Assigned Fund Balance* – amounts intended by the Board for specific purposes. The Board expressly delegates to the Superintendent, through the Chief Financial Officer, the authority under this policy to assign funds for particular purposes. Such assignments cannot exceed the available fund balance in any particular fund.
- e. *Unassigned Fund Balance* – residual spendable fund balance after subtracting all above amounts.

2. **Spending Prioritizations:**

- a. When an expenditure is incurred that would qualify for payment with either restricted or unrestricted funds, it will be paid from restricted funds.
- b. When an expenditure is incurred that qualifies for payment from either of the three unrestricted fund balance categories, it will be applied in the following order:
 - (1) Committed,
 - (2) Assigned, and
 - (3) Unassigned.

ACCOUNTING AND REPORTING (continued)

3. **Minimum Unassigned Fund Balance:**

The District will strive to maintain a minimum unassigned fund balance in its General Fund of at least 8.33% of budgeted expenditures. This minimum fund balance is to protect against cash flow shortfalls related to timing of projected revenue receipts and to maintain an emergency funding source.

4. **Replenishing Unassigned Fund Balance Deficiencies:**

When the Unassigned Fund Balance falls below the minimum of 8.33%, the District will replenish shortages/deficiencies using the following budget strategies and timeframe:

- a. The following budgetary strategies shall be utilized by the District to replenish fund deficiencies:
 - (1) The District will reduce recurring expenditures to eliminate any structural deficit;
 - (2) The District will increase recurring or one-time revenues or pursue other funding sources; or
 - (3) Some combination of the two options listed above.
- b. Minimum Unassigned Fund Balance deficiencies shall be replenished within the following time period:
 - (1) Deficiency resulting in a minimum Unassigned Fund Balance of less than 8.33% shall be replenished over a period not to exceed two (2) years.

5. **Total Fund Balance:**

Should the Total Fund Balance of the General Fund ever exceed 15% of budgeted expenditures, the District will:

- a. Utilize excess funds for one-time expenditures that are non-recurring in nature and which will not require additional future expense outlays for maintenance, additional staffing or other recurring expenditures; or
 - b. Consider transferring excess funds to a separate Capital Accumulation Fund (Committed Fund Balance).
6. Pursuant to the provisions of GASB Statement 54, the Board hereby commits substantially all of the revenue received by the following Special Revenue funds to be used exclusively for each respective program's operating expenditures.

<u>Special Revenue</u>	<u>Committed Revenue Source</u>
Donations	Donations by individuals or organizations to benefit school programs
After School Program	Attendance and registration fees of After School Program (ASP)
Performing Arts	Voluntary student contributions to fund Performing Arts Program
Tuition School	User tuition charges
Facility Use	User rental fees
Adult High School	User tuition/GED fees
Public Safety	Student Parking Permit Fees
Artists at School	Donations to fund artist workshops at local schools

ACCOUNTING AND REPORTING (continued)

Local Schools Funds earned or donated at local schools are to be used by local principals to benefit students and faculty subject to District policy.

D. DEBT MANAGEMENT:

1. Objectives:

The primary objective is to ensure prudent debt management practices which:

- a. Maintain financial stability
- b. Preserve public trust
- c. Minimize costs to taxpayers
- d. Minimize borrowing costs
- e. Demonstrate adequate administrative oversight of debt programs to credit rating agencies

2. State of Georgia Law Debt Limit:

The District will manage its debt in compliance with O.C.G.A. § 20-2-390 *et seq.*

3. Short Term District Debt:

- a. Definition – For purposes of this policy, short-term debt refers to debt with a repayment term of one (1) year or less.
- b. Short Term Debt Mitigation – The District will strive to maintain a minimum unassigned fund balance in its General Fund of at least 8.33% of budgeted expenditures (one-month reserve). This minimum fund balance is to protect against cash flow shortfall related to timing of projected revenue receipts and to maintain an emergency funding source.
- c. Authorized Short Term Debt – In the event of short term cash needs, the district is authorized to issue short-term debt in compliance with O.C.G.A. § 20-2-390 *et seq.*

4. Long Term District Debt:

- a. Definition – For purposes of this policy, long-term debt refers to debt with a repayment term of greater than 1 year.
- b. Long Term Debt Mitigation – The District will strive to be free of Long Term Debt. The District's participation in the Special Purpose Local Option Sales Tax (SPLOST) revenue program will continue to be the District's primary source of funding to provide for school facilities, technology and capital needs.
- c. Authorized Long Term Debt – In the event of long term cash needs, the District is authorized to issue long-term debt in compliance with O.C.G.A. § 20-2-390 *et seq.*

E. FINANCIAL ADVISOR SERVICES:

The District shall have the option of retaining a Financial Advisor to provide independent financial advice to the Chief Financial Officer and the Board. The various financial advice topics are:

1. Short Term Borrowing;
2. Long Term Borrowing;
3. Financial Project Coaching; and
4. Financial Investment Advice

ACCOUNTING AND REPORTING (continued)

F. FINANCIAL PRACTICES:

1. On-time Payments:

The District shall:

- a. Settle payroll and debts in a timely manner;
- b. File accurate and on-time tax and other government ordered payments and financial filings.
- c. Not acquire real property for investment purposes; and
- d. Aggressively pursue receivables after a reasonable grace period.

2. Procedures:

The procedures developed and implemented by the Superintendent or designee shall:

- a. Provide for the consistent accountability of all District funds;
- b. Require that District personnel have itemized receipts for cash purchases and that other purchases be supported by purchase orders or contracts with payment made only upon receipt of original invoices;
- c. Require that District personnel not collect funds from students for expenditures that are included in the District budget;
- d. Require District personnel to maintain a clear audit trail from receipt of funds to disbursement of funds;
- e. Provide for an annual audit of student activity funds by either an internal or external auditor;
- f. Account for the disposition of surpluses or deficits from completed projects; and
- g. Provide for an annual audit of all District funds and the payment of costs for external auditors from the funds being audited.

3. Line Items Transfers:

The Superintendent will request Board approval of all budget transfers in accordance with state budgeting amendment procedures. Budgeted funds assigned to Department heads and Principals can be transferred between their line item accounts with the exception of salary and fringe benefit accounts. To implement these budgeting procedures the Superintendent and staff will develop, review and maintain up-to-date Financial Services Regulations governing budget transfers of all District funds to ensure good fiscal responsibility.

4. Investment of District Funds:

Effective cash management is recognized as essential to good fiscal management. The extent to which the cash manager can obtain investment returns on funds not immediately required can provide additional needed financial resources. This requires that investments be well founded and uncompromisingly applied in legal, vendor, and administrative aspects.

a. Depositories:

All District central funds shall be deposited to the credit of the District. The bank depository for the District's daily operating central funds will be selected through standard bidding procedures and approved by the Board Chair.

b. Investment Authority:

- (1) The Board delegates the authority to invest the District's idle funds to the Chief Financial Officer (CFO) or designee;

ACCOUNTING AND REPORTING (continued)

- (2) The CFO or designee:
 - (a) Has the authority to sign all paperwork required by investment or banking institutions to open investment accounts unless additional signatures are required; and
 - (b) Will provide a quarterly investment report to the Board.

c. Guidelines:

- (1) The District will emphasize the preservation of investment principal and conform with Federal and State legal requirements.
- (2) The financial administration will maintain sufficient liquidity to meet funding needs.
- (3) Investments will be diversified to avoid incurring unreasonable risks regarding specific investments or individual banks.
- (4) Investments will be made that will attain the best market rate of return considering liquidity based on projected expenditure needs.

G. PROCUREMENT PRACTICES:

1. Purchases:

Purchases are defined as the obtaining of goods or services via purchase orders, check requests, performance contracts, construction contracts, other contracts, or procurement cards.

2. General Provisions:

The Board expects the Superintendent and his/her staff to establish procedures for the procurement of supplies, equipment and services for the District that complies with generally accepted purchasing principles, District procedures and Georgia Department of Education Rules, Georgia laws and federal laws. Specifically, the District shall make purchases that are consistent with the purchasing principles of:

- Acceptable quality at lowest price;
- Transparency in use of public funds;
- Protection against conflict of interest;
- Maximization of competition;
- Equal and fair competition; and
- Legal/regulatory compliance.

3. Solicitation Process:

- a. All purchases are subject to the competitive solicitation process if the anticipated annual cost is \$10,000 or more and an Exception to Full and Open Competition as defined in the District Purchasing Regulations does not apply.
- b. The Superintendent or designee shall set solicitation dates and opening time according to District procedures and State rules. The District shall be represented by appropriate staff members at all bid openings including at least one representative from Procurement Services. The Procurement Services staff member representing the District shall call the time for receiving solicitation responses closed at the time specified in the solicitation document(s). Solicitation responses will not be accepted after the time specified in the solicitation document has been called.

4. Board Approval:

Specific Board approval shall be required for all purchases greater than \$200,000 except those purchases specifically pre-approved by the Board and/or those purchases that are within a Board approved bid/RFP. The Board may change its list of

ACCOUNTING AND REPORTING (continued)

pre-approved items at any time (see Board Policy DB [Planning, Programming, Budgeting System]).

5. **Contracts:**

a. **Contracts for Good and Services:**

All District Standard Contracts for Goods and Services, including purchase orders and performance contracts, require the following approval:

- (1) All District generated contracts for the purchase of non-construction goods and services on the Board pre-approved list shall be approved and executed by the Director of Procurement Services.
- (2) All District generated contracts for the purchase of non-construction goods and services in excess of \$200,000 annually and not on the Board pre-approved list shall be approved by the Board. Upon approval by the Board, the Director of Procurement Services shall execute the contract.
- (3) A copy of each standard contract form used by the District shall be filed in the office of the attorney and shall be reviewed annually by the attorney and the Director of Procurement Services.
- (4) Contracts other than those of District standard form shall be reviewed by the attorney and Director of Procurement Services.

b. **Construction Contract Approval:**

All District generated contracts for construction and construction related services require the following approval:

- (1) Construction contracts in the amount of \$25,000 or less shall be approved by the appropriate Division head and executed by the Superintendent or designee;
- (2) Construction contracts in the amount of \$25,001 to \$200,000 will be approved and executed by the Superintendent or designee;
- (3) Construction contracts in excess of \$200,000 will be recommended by the Superintendent and approved by the Board of Education. Superintendent or designee to execute contract.

6. **Vendor Evaluation:**

Vendor performance, including those vendors providing contracted services, will be routinely evaluated using procedures outlined in District Procurement Regulations.

H. **BOARD OF EDUCATION REPORTS:**

The Superintendent or designee shall:

1. Provide the Board quarterly reports of the financial activities of the District;
2. Notify the Board of the following:
 - a. Expenditures greater than \$100,000;
 - b. Budget line item increases of both 20% or more, and at least \$100,000.
3. Provide a year-end, pro forma, general fund financial statement for the preceding fiscal year no later than the October Board Work Session each year.

GRANTS
(District Administrative Rules DFF-R)

RATIONALE/OBJECTIVE:

The Cobb County School District (District) seeks to maximize its sources of revenue for the benefit of students, employees and taxpayers.

RULE:

The District recognizes and appreciates that organizations and/or individuals may wish to award grants, contribute gifts, make donations or provide sponsorships to the schools in the District. The system reserves the right to determine if the grant, gift, donation, or sponsorship is appropriate and may reject those it deems inappropriate or unsuitable.

A. General Provisions:

To be acceptable, a grant, gift, donation, or sponsorship must:

1. Have a purpose consistent with the beliefs/philosophy of the school system;
2. Not bring undesirable or hidden costs to the school system;
3. Place no undesirable restrictions on the Board;
4. Not be inappropriate or harmful to the best education of students;
5. Not imply endorsement of any business or product or belief; and
6. Not be in conflict with any Board Policy, Administrative Rule, state law, or District financial procedures.

B. Grant Application:

The District, including schools and District divisions, are encouraged to apply for competitive grant funding from sources including local, state, and federal government as well as non-governmental agencies and organizations. For the purpose of this Rule, competitive grants are defined as those grants that are awarded through an application process in which multiple grant applications are solicited through a grants notice or request for proposal.

1. Office of Grants Administration:

Employees considering applying for a grant in the amount of \$10,000 or more should first contact the District's Office of Grants Administration for guidance and to insure compliance with Administrative Rules related to the approval process;

2. Required Compliance:

- a. The District shall comply with all local, state and federal rules and regulations concerning these grant programs;
- b. All grants applied for shall comply with Board of Education (Board) Policy, District Administrative Rules and District procedures including but not limited to the following:
 - (1) Board Policy DB (Planning and Budgeting);
 - (2) Board Policy DI (Accounting and Reporting);
 - (3) Board Policy CEB (Superintendent Duties);
 - (4) Board Policy KB (Public Information Program);
 - (5) Administrative Rule GBRG-R (Non-school Employment);
 - (6) Administrative Rule GAKA-R (Reduction in Force)
 - (7) Administrative Rule FEAE-R (Construction on District Property Funded by Others)

GRANTS (continued)

- c. Prior to submission of each competitive grant application with an award of \$10,000 or more, participation in basic District Policies & Procedures for Grants training must be completed by the local school staff and any participating Central Office Staff.

C. District Approval:

1. Administrative:

- a. Grant applications in the amount of \$10,000 or more:
Prior to submission, all grant applications in the amount of \$10,000 or more shall have the approval of:
 - (1) The applicant's principal, department head and/or division head;
 - (2) Other District office personnel as appropriate;
 - (3) The Office of Accountability;
 - (4) The Senior Staff and/or Superintendent.
- b. Grant applications in an amount under \$10,000:
All grant applications in an amount under \$10,000 shall have the approval of the local school principal.
- c. Grant Applications that require a contract (see Section D below):
Prior to submission, all grant applications of any amount that require a contract shall have the approval of:
 - (1) The applicant's principal, department head and/or division head;
 - (2) Other District office personnel as appropriate;
 - (3) The Office of Accountability;
 - (4) The Senior Staff and Superintendent.

2. Board:

a. Initial:

The Superintendent and/or Board shall approve any grant that:

- (1) Requires a special appropriation from the General Fund prior to the acceptance of the grant's funding; or
- (2) Specifically requires Board approval.

b. Continuing:

In subsequent years:

- (1) These funds shall be disclosed in the District's annual budget in compliance with Board Policy DB (Financial Planning and Budgeting) requirements regarding non-recurring project funds; and
- (2) The continuing acquisition of these funds shall be based on Board approval of the annual budget.

D. Legal Review:

Once a grant has been awarded, any required contract must be reviewed and approved by the Board Attorney, Superintendent and/or Board in compliance with Board Policy BBA (Board Powers and Responsibilities).

E. Matching Funds:

Any grant application which requires "Matching Funds" which are not currently budgeted must be presented to Senior Staff for review and approval. It will be the

GRANTS (continued)

determination of the Senior Staff to send the “request for matching funds” to the Board along with appropriate documentation to request the additional funds needed for the final grant approval. This final decision will be made only AFTER a pre-award has been granted by the grantor.

F. Grant, Gift and Donation Expenditures:

All grant, gift, and donation expenditures must follow District financial procedures.

G. Quarterly Report of Competitive Grants:

Quarterly reports will be submitted to the Board in the form of a written report outlining all competitive grants of more than \$10,000 received on behalf of the Cobb County School District.



AUDITS
(District Administrative Rules DID-R)

RATIONALE/OBJECTIVE:

Internal Audit is an independent appraisal function established within the Cobb County School District (District) to document financial integrity and to promote efficiency, effectiveness and economy in District operations.

RULE:

A. RESPONSIBILITIES:

Internal Audit shall:

1. Perform independent audits, examinations and investigations and report results and outcomes;
2. **Verify compliance with:**
 - a. Laws and regulations;
 - b. Board Policies;
 - c. District Administrative Rules; and
 - d. Written departmental procedures;
3. **Evaluate internal controls and seek improvements that will:**
 - a. Enhance the District's performance;
 - b. Reduce the risk of fraud and other corrupt/illegal conduct (Administrative Rule DIE-R [Fraud Prevention]); and
 - c. Increase accountability to the public.

B. AUTHORITY:

1. **Scope:**

All District schools, departments, programs and functions are subject to audit by Internal Audit;

2. **Access:**

Internal Compliance shall have full, free and unrestricted access to all District functions, records, and property.



FRAUD PREVENTION
(District Administrative Rules DIE-R)

RATIONALE/OBJECTIVE:

The Cobb County School District (District) has a responsibility to uphold the public trust. Internal Compliance is an independent auditing and assessment function established to promote and document efficiency, effectiveness, economy, and financial integrity in District operations.

RULE:

District employees are subject to the requirements of the Georgia Professional Standards Commission Code of Ethics for Educators (Administrative Rule GAGC-R [Employee Ethics]). In addition to the professional requirements, the District identifies the following actions as examples of prohibited conduct, and establishes the following guidelines for reporting their occurrence or suspected occurrence:

A. MISCONDUCT:

This includes, but is not limited to:

1. Any crime defined in Title 16 of the Official Code of Georgia Annotated (O.C.G.A.) or any applicable federal law involving dishonesty or fraud.
2. Inappropriate conduct or the appearance of inappropriate conduct that does not rise to the level of criminal activity including, but not limited to:
 - a. Approving, encouraging or participating in any financial or business transaction or activity which presents, or could be reasonably interpreted to present, a real or potential conflict of interest, whether as defined in District Administrative Rules GAG-R and GAGC-R, or otherwise;
 - b. The failure to provide or withholding of information that could affect a financial or business decision under consideration by the District or that results in an undue loss or expense to the District, which loss or expense could have been avoided or mitigated had such information been disclosed;
 - c. Abuse, misuse, or destruction of District property, funds, or other resources; and
 - d. Violations of the Code of Ethics.

B. NOTIFICATION:

1. An employee who knows of or suspects financial fraud, or other financial misconduct shall immediately report such suspicions to Internal Compliance.

2. Audit Procedures:

Internal Compliance shall:

- a. Refer the financial misconduct matter to Human Resources Employee Relations for resolution and action;
- b. As appropriate, audit financial records and transactions and document the facts and findings of such audit in a written report and forward to Human Resources Employee Relations.

3. Reprisals:

No action shall be taken or threatened against any employee for reporting the occurrence or suspected occurrence of any of the above conduct unless the complaint was made with the knowledge the allegation was false.

STUDENT ACTIVITIES FUNDS MANAGEMENT
(District Administrative Rules DK-R)

RATIONALE/OBJECTIVE:

The Cobb County Board of Education (Board) Policy DI (Accounting and Reporting) establishes the expectation that the Cobb County School District (District) will establish financial guidelines and procedures that comply with generally accepted accounting principles, State Department of Education rules, and District expectations established in Board Policy DB (Planning, Programming, Budgeting System). Board Policy DI necessitates the establishment of clearly stated and understood guidelines for the consistent accountability of these funds.

RULE:

A. GENERAL PROVISIONS:

1. Revenues:

Funds collected from students and other sources for student activities shall be committed for the intended purpose of the school-related program and/or activity in accordance with the District's Local School Accounting Standard Operating Procedures Manual.

2. Expenditures:

All payments and purchases must be authorized by the Principal or Principal's designee as prescribed in the District's Local School Accounting Standard Operating Procedures Manual and purchasing regulations.

3. Reporting:

Financial Services shall make a quarterly report of all receipts and disbursements of each local school to the Board.

B. ATHLETIC GATE RECEIPTS/TICKET SALES:

Schools finance the operations of athletic programs through gate receipts from regular season competitions, gate receipts from playoff competitions in accordance with Georgia High School Association rules, donations from Booster Organizations, or from corporate partnerships.

Guidelines and procedures for athletic/special event gate receipts/ticket sales may be found in the District's Local School Accounting Standard Operating Procedures Manual.

C. ATHLETIC CONCESSION MONIES:

District guidelines for the accounting and reporting of high school athletic concession monies are as follows:

1. School Receives Proceeds:

If the school is the direct recipient of the monies received from the sale of athletic concessions, the monies shall be handled in accordance with procedures specified by the Financial Services Division.

2. Booster Club Received Proceeds:

Booster Organization monies shall be handled in accordance with Administrative Rule LEC-R (Booster Organizations)

PUBLIC INFORMATION PROGRAM

(Policy Index KB)

With respect to the community, the Cobb County Board of Education (Board) expects the Superintendent to actively encourage input and engagement, especially with parties that are directly affected by Cobb County School District (District) operations.

Accordingly, without limiting the above, the Superintendent shall establish procedures to:

1. Be responsive, whether directly or through appropriate staff, in timely communications with parents/guardians.
2. Utilize personal communications.
3. Seek evaluative feedback from persons directly affected by (District) operations.
4. Seek input from parents/guardians into major changes in District operation.
5. Inform parents/guardians about major changes in the District. This includes:
 - a. Programmatic changes; and
 - b. Notification of owners of property contiguous to the involved District property that the Board has approved an outside facility construction project for said property. The notice shall be by certified and first class mail and shall be mailed at least five days prior to the start of the actual construction project. Projects requiring notice include, but are not limited to, the following:
 - (1) Building additions;
 - (2) Telecommunications facilities/Cellular towers (See Administrative Rule FJA [Construction of/Improvements to Facilities on District Property by Community Organizations or Individuals]);
 - (3) Property-line fencing;
 - (4) Parking lot changes;
 - (5) Retention ponds; and
 - (6) Re-roofing.
6. Establish and maintain processes to engage, and a variety of opportunities to involve, citizens in the education of Cobb County children.
7. Encourage the parents and guardians of students attending District schools to actively participate in their respective school's PTA/PTSA.
8. Promote the visibility of the Board when representing the District at external functions and with elected leaders on political issues.



PARTNERS IN EDUCATION
(Policy Index LE-R)

RATIONALE/OBJECTIVE:

The Cobb County School District (District) recognizes that community partnerships enable the District and individual schools to reach beyond their immediate financial, personnel, physical and curriculum resources to provide options for student learning that may not otherwise be available. The District also recognizes that community partnerships expose business and industry owners and employees, professionals and community leaders to the schools and the broad range of intellectual and social experiences that occur within them. Lastly, the District acknowledges that community partnerships help meet basic student support needs, thereby improving students' ability to learn and raising their aspirations.

RULE:

A. MISSION:

The mission of the Partners in Education Program is to establish and support partnerships that utilize community resources to enrich and extend the education opportunities for Cobb County students.

B. COBB CHAMBER OF COMMERCE:

The Cobb Chamber Partners in Education Program (Program) is coordinated by the Cobb Chamber of Commerce's Education Department (Chamber). Contacts for the Program are as follow:

1. The Chamber contact is the Education Department Manager;
2. The District contact is the Chief of Staff.

C. PARTNERSHIPS:

1. Establishing Partnerships:

Businesses interested in becoming Partners in Education should contact the Chamber directly or indicate their interest to the Principal of the school with which they would like to become a Partner. Additionally:

- a. Partnerships may be established at any time;
- b. Partners do not have to be members of the Chamber; and
- c. Principals should review information regarding potential Partners in order to make informed decisions regarding the establishment of a Partnership.

2. Partners in Education Coordinator:

Principals shall appoint a staff member to serve as the school's Partner in Education Coordinator (Coordinator). The Coordinator should:

- a. Serve as the school's contact person for the Partner;
- b. Facilitate ongoing communication between the school and the Partner;
- c. Assist in the development of Partnership Plan/s as described below; and
- d. Schedule time and place for Partnership activities.

3. Ending Partnerships:

- a. Partnerships may be ended by either the school or the Partner.
- b. If the Principal determines that a Partnership is not working for the for any reason, he/she should notify the Partner that the school will not be renewing the Partnership at the end of the school year or at another time in the discretion of the Principal with consultation with the Assistant Administrator, Office of the Superintendent. The Chamber will assist with this communication if requested by the Principal.

PARTNERS IN EDUCATION (continued)

D. PARTNERSHIP PLAN:

1. Each school participating in the Program collaborate with each of its Partners to develop a Partnership Plan (Plan). The Plan is valid for two years and should:
 - a. Be viewed by both the school and the Partner as a starting point for partnership activities and should not limit the activities of the partnership;
 - b. Highlight the most significant activities/contributions planned as a result of the partnership;
 - c. Include at least one such activity/contribution per quarter of the calendar year;
 - d. Anticipate that additional needs may arise; and
 - e. Include activities that the school can do for their Partner as well as activities the Partner is doing for the school.
2. Copies of the completed Plan are to be submitted to the Chamber of Commerce and the appropriate Area Assistant Superintendent.
3. The Chamber will notify Partners and/or schools when it is time to renew the Plan.

E. EXPECTATIONS/LIMITATIONS:

All Partners in Education are subject to all Policies and Rules of the District and the school. These include, but are not limited to, the requirements found in Administrative Rule KM-R (Visitors to School); Administrative Rule KG-R (Advertising in the Schools); and Administrative Rule KJ-R (Use of School Facilities).



AUTHORIZATION OF ENHANCED SECURITY

(Policy Index GAMB)

The Cobb County Board of Education (Board) is committed to maintaining a safe and secure working and learning environment. Unless authorized by the Board or Superintendent accordance with this policy, or specifically authorized by state law, employees shall be prohibited from bringing weapons on any property or in any building owned or leased by the Cobb County School District (District), at school functions, and on school buses or other transportation furnished by the District, as those terms are defined by O.C.G.A. 16-11-127.1. Employees in violation of this policy shall be subject to disciplinary action, up to and including termination of employment.

Pursuant to O.C.G.A. § 16-11-130.1, the Superintendent may authorize certain personnel to possess or carry weapons on any property or in any building owned or leased by the District, at a school function, in school safety zones, or on a bus or other transportation furnished by the District (as those terms are defined by O.C.G.A. 16-11-130.1), subject to the following conditions:

- Personnel whose primary responsibility is classroom supervision will not be authorized to possess or carry weapons.
- Personnel who have been authorized in writing to have in such person's possession or use within a school safety zone, at a school function, or on a bus or other transportation furnished by a school a weapon will be provided written verification which will specify the weapon or weapons which have been authorized and the time period during which the authorization is valid.
- Training of approved personnel shall occur prior to their authorization to carry weapons. The training shall be approved in advance by the Superintendent and shall, at a minimum, include training on judgment, pistol shooting, marksmanship, and a review of current laws relating to the use of force for the defense of self or others. The Superintendent may substitute for certain training requirements an individual's prior military or law enforcement service if he or she has previously served as a certified law enforcement officer or has had military service which involved similar weapons training.
- An approved list of the types and quantity of weapons and ammunition authorized to be possessed or carried shall be prepared and maintained by the Superintendent.
- Selection of personnel to possess or carry a weapon shall be done strictly on a voluntary basis and no personnel will be terminated or otherwise retaliated against for refusing to possess or carry a weapon. The final appointment will be made by the Superintendent consistent with the requirements of this policy. Each employee appointed must be licensed under the laws of the state to carry a firearm and shall be subject to an annual criminal history background check. Approval will not be granted for any employee who has had an employment or other history indicating any type of mental or emotional instability as determined by the Superintendent after review of relevant documentation and information. The Superintendent shall be able at any time to remove or suspend the authority granted to any employee under this policy.

AUTHORIZATION OF ENHANCED SECURITY (Continued)

- Weapons possessed or carried by personnel under this paragraph shall be secured as follows: Concealed weapons are permitted if they are carried on the person and not in a purse, briefcase, bag, or similar other accessory which is not secured on the body. If maintained separate from the body, the weapon shall be maintained in a secured lock safe or similar lock box that cannot be easily accessed by students or unauthorized individuals.

In addition to those employees appointed pursuant to this policy, the Board recognizes that other exceptions exist under O.C.G.A. §16-11-127.1. All records regarding the appointment of individual employees and the implementation of this program shall be exempt from production under the Open Records Act as specified in Georgia law.

The Superintendent is authorized to develop procedures consistent with this Policy.



FY2023 BUDGET DEVELOPMENT PROCESS

BUDGET PROCESS SUMMARY

A local government budget is a financial plan that details the government's projected revenues and expenditures on specified programs, functions, activities, or objectives.

The budget process is the procedure used by local government to develop the annual budget. It includes the details of schedules and who is responsible for information gathering or review.

Cobb County School District budget preparation process extends for a period of approximately twelve months beginning on July 1. All funds are budgeted by the District on an annual basis. The fiscal year (July 1 through June 30) budget must be submitted to the seven members of the local Board of Education. Budget sessions with the Board and official public budget meetings are conducted. After the Board's legal adoption, the new fiscal year budget is submitted to Georgia DOE by the required deadline, typically October 31 for a formal approval.

General Budget Development Methodology

The budget will be developed utilizing a **structural balanced budget** philosophy where actual recurring revenue equals recurring expenditure appropriations. If one-time funds are used from fund balance to assist in balancing the General Fund budget, the expenditure appropriations associated with those one-time funds shall be identified as part of the budget approval process and the Board will identify recurring funds for these expenditure appropriations in the immediate subsequent budget development year. The Board shall maintain the objective to keep the General Fund reserve at a level of at least 8.33% (One Month Reserve) of General Fund Expenditure Appropriations. (Board Policy DB section B.1.c)

Conservative Budget Practices

Conservative budget development practices will continue to allow for extra budget flexibility in future budgets. Practices include the utilization of average teacher salaries even when beginning teachers are hired, revenue estimates based on the most recent data, conservative projections of revenue and expenditures; strict budget development policies, etc.

Budget Reduction

The Cobb School Board has clearly demonstrated the courage to make expenditure reductions when necessary to balance the General Fund during previous fiscal years. Successful historical performance of position cuts and expenditure cuts assisted in the budget balancing process while minimally impacting the instruction of students yet maintaining student performance.

Student Achievement Driven Funding Analysis

Continually analyze existing instruction and support functions to see if adequate results have been achieved. The budget development process has frequently redeployed funding from less successful programs to new innovative programs which assist in student achievement.

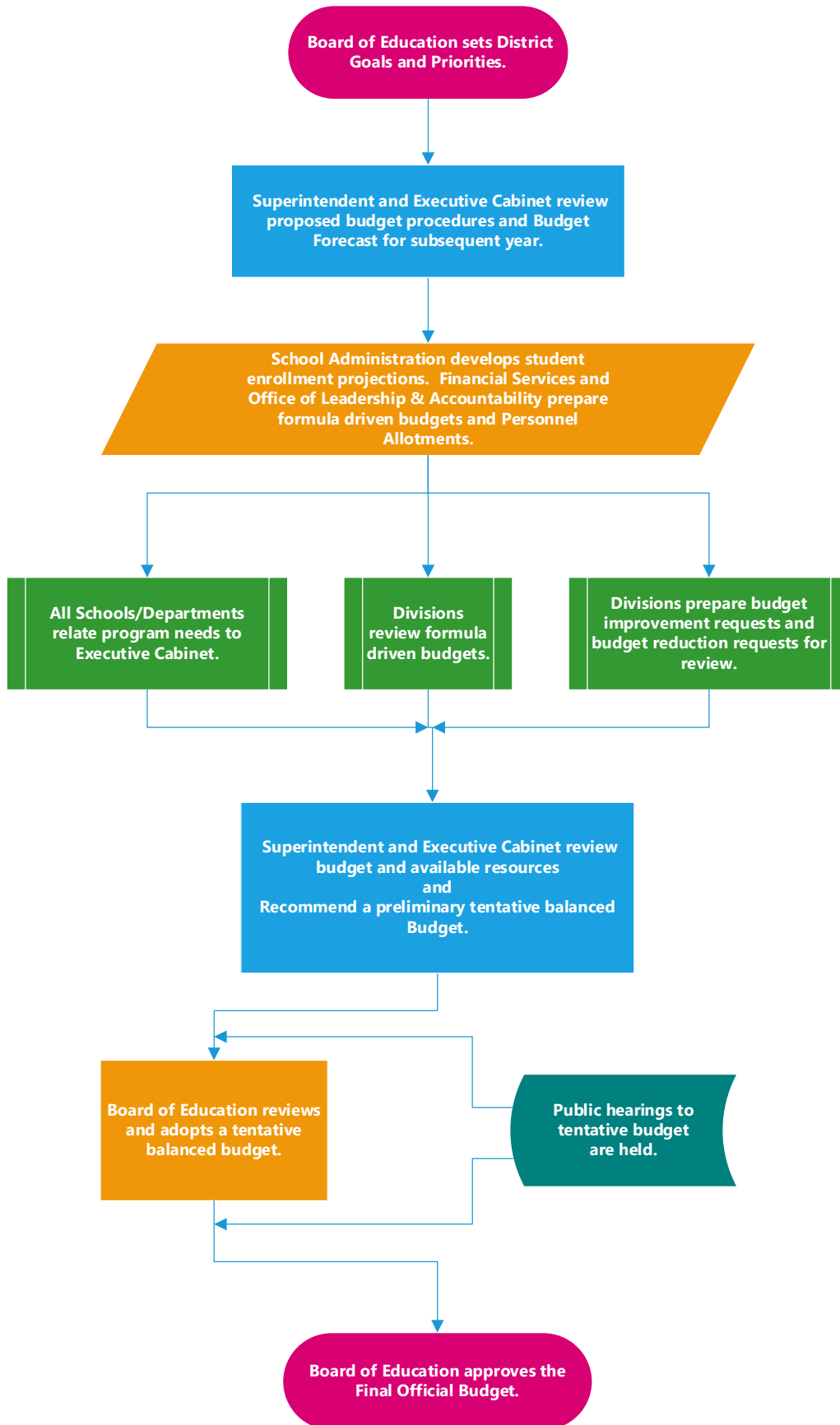

FY2023 BUDGET DEVELOPMENT TIMELINE AND CALENDAR

The budget preparation process extends for a period of approximately twelve months beginning in July. All funds are budgeted by the district on an annual basis. The fiscal year (July 1 through June 30) budget must be submitted to the local seven-member Board of Education prior to June 30 for legal adoption. The following are the major budget process elements included in the school district budget process:



BUDGET AMENDMENT PROCEDURES

General Guidelines

The chief administrator of each department is responsible for the initiation of a budget amendment. A budget amendment is required when a department head desires to deviate from the original board approved budget. Each budget administrator is responsible for being knowledgeable about his or her assigned accounts and for the management of his or her assigned accounts. Department budget administrators CANNOT exceed their budgets. The State of Georgia does not permit deficit budgets. Additionally, strict QBE requirements necessitate timely budget adjustments so that account expenditures may be properly monitored for QBE compliance.

Budget Amendment Justification

All budget amendments must have proper documentation to explain why money is being moved. If there is a budget adjustment for the transfer of funds from one account to another, there must be an explanation for the use of the funds.

MUNIS System Budget Amendment Procedure

The Budget Transfer and Amendment program performs current year budgetary transactions. This may reduce one budget line and increase the other or subtract from the bottomline budget amount for either revenue or expense accounts.

- Workflow settings and business rules are established for the transfer and amendment process.
- The budget amendment initiator has the appropriate user and account permissions to access and enter the budget transaction. Supporting documents must be attached to the transaction.
- This transaction will be released through a workflow process that requires each approver to review and take appropriate action (Approve, Reject, Forward, Hold).
- Once final approval has been granted, the transaction will be posted to the budget account by Financial Planning & Analysis (FP&A).

MUNIS Budget Rollup Codes

In the Munis Financial System, expenditures are controlled by account groupings called **Budget Rollup Codes**. The District's Accounting Services department creates and maintains the General Ledger Chart of Account segments. The office of Financial Planning & Analysis (FP&A) uses the existing segments to create accounts. FP&A also creates and associates Rollup Codes for accounts to accommodate related appropriations.

Budget Rollup code classifications allow flexibility to spend budgeted funding throughout all accounts within the grouping. A budgeted amount is assigned and loaded to major expenditure accounts during the creation of the initial school budget. During the budgeted year, the actual operations may require the need for additional accounts to ensure proper expenditure recording within this roll up. A budget administrator may ask FP&A to set up zero budget accounts within their scope of responsibility to purchase items that were previously not budgeted, providing that the expense is kept within its Budget Rollup limits. The system will accept expenditures to any account line within the Budget Rollup group (including non-budgeted or zero budget accounts).

BUDGET AMENDMENT PROCEDURES (Continued)

Capital Projects Budget Amendments

All budget adjustments for SPLOST related funds are prepared by the Capital Projects Accounting Department. Any budget adjustment necessary as a result of a purchase order or a change order to a capital project must accompany the order document for approval. No encumbrances or expenditures will be processed until a budget adjustment has been approved and signed by all appropriate administrators.

Grant Budget Amendments

All grants are the responsibility of the grant administrator. It is the policy of Financial Services to continue recurring grant budgets at the previous year's dollar amount. If the grant administrator is aware of upcoming federal/state appropriation increases or decreases, it is his/her responsibility to adjust the budgets as soon as possible. These preliminary budgets are "Estimates" only. The grant administrator is responsible for adjusting these budget estimates to the current year grant approved amounts for revenue and expenditures as soon as the approved amounts are ascertained, and proper document received. The grant administrator should be in constant contact with the grant agency to ensure all rules and procedures relating to the grant are followed. The grant administrator is required to be proactive to ascertain the current grant procedures and current approved grant amounts. The grant administrator is responsible for budget over-expenditures and under-expenditures. Before a grant application is submitted to the Board or State/Agency, the grant administrator is required to provide a copy of the grant for review by the grant accountant.



BUDGET AMENDMENT PROCEDURE (Continued)

Budget Amendment Process Flow Chart

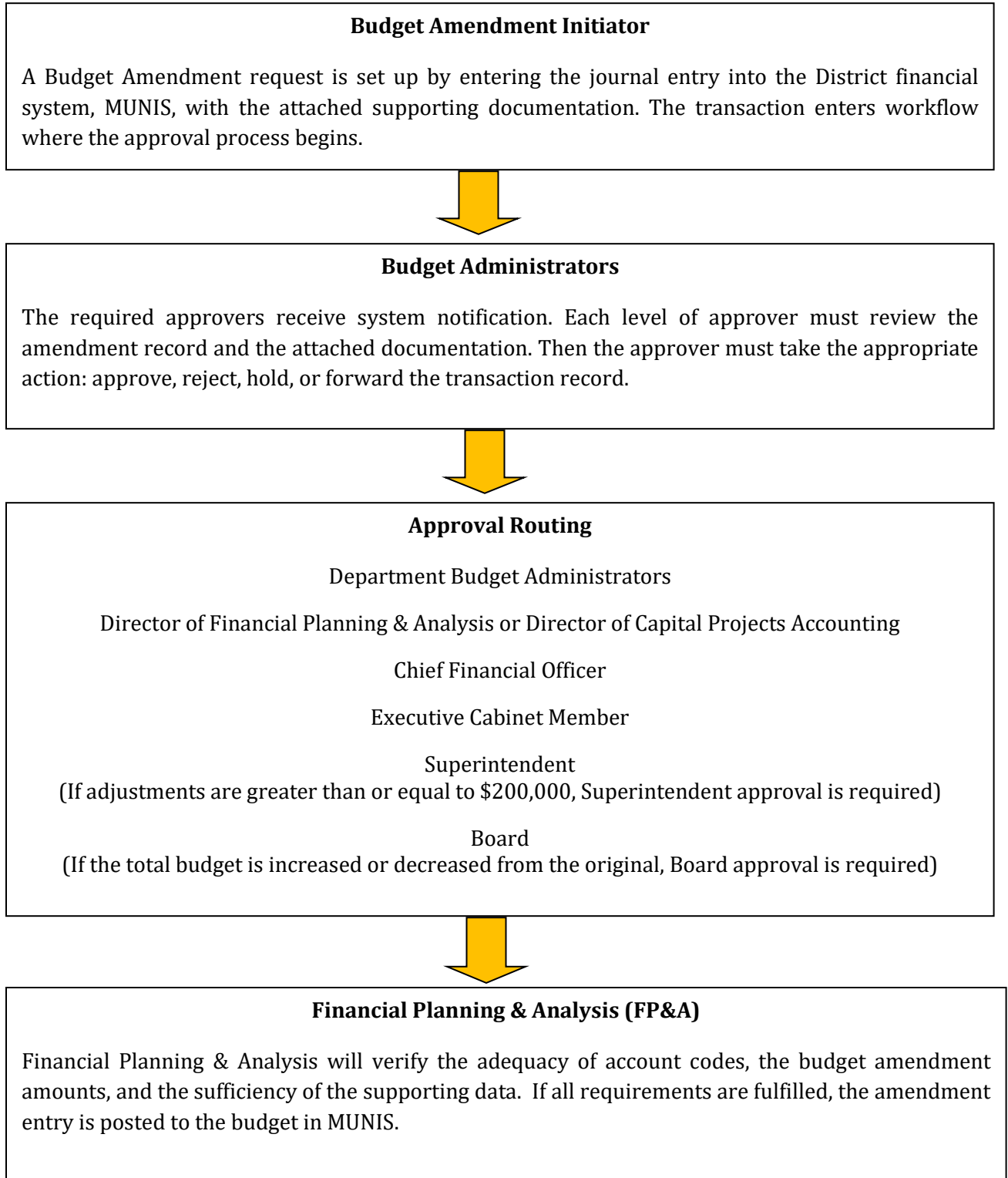

CAPITAL BUDGET DEVELOPMENT PROCESS

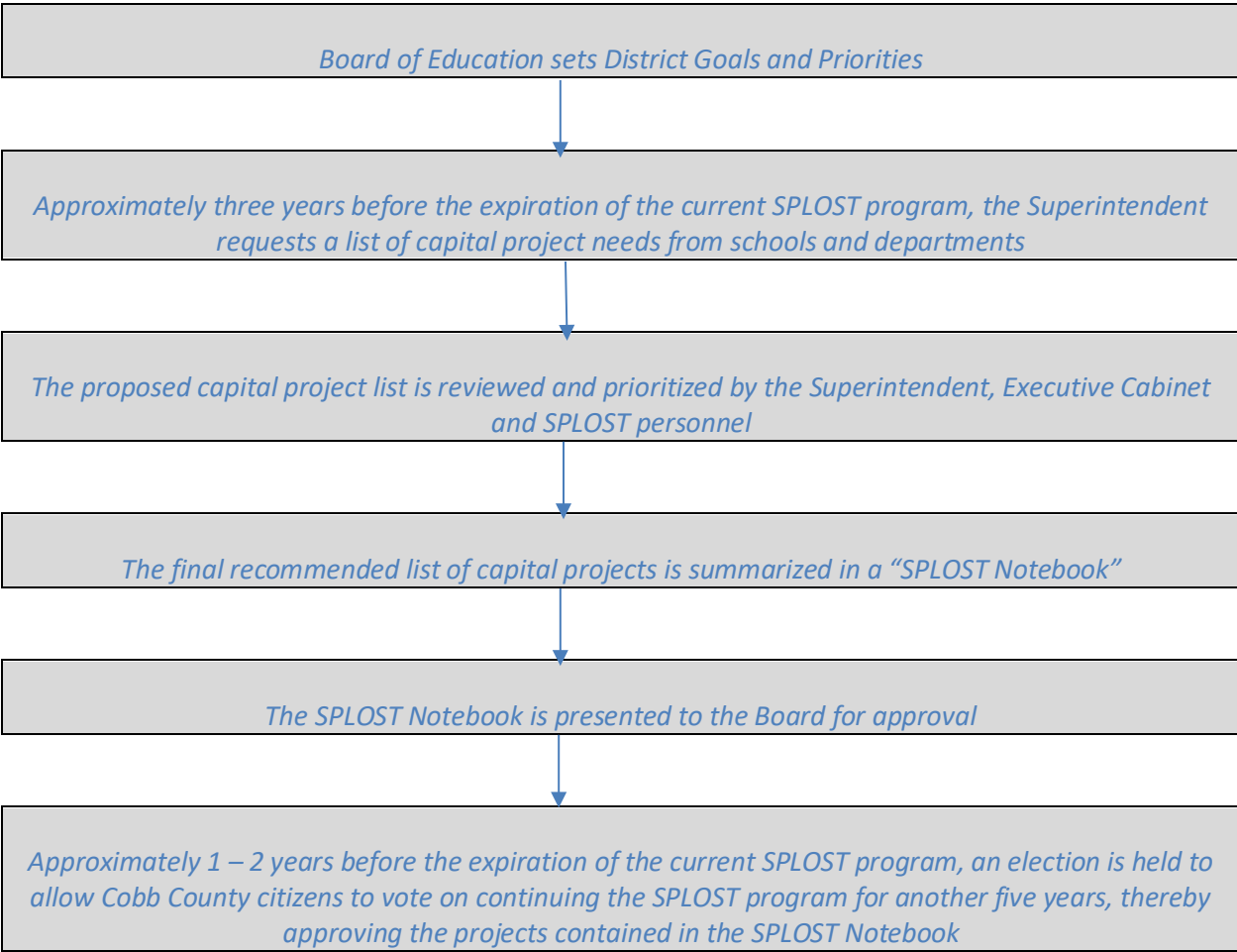

CAPITAL PROJECTS APPROVAL AND BUDGET ADJUSTMENT GUIDELINES

Reviewer & Approvers

		Capital Projects Manager, Assistant Director or Director	SPLOST Director of Accountability	Administrator in Charge of the Project / Program (Non Construction)	Executive Director SPLOST Program
1	Initial Budget Adjustment SPLOST Setup in the Munis System and reconcile with the SPLOST Master Cash Flow.	X	X		X
2	Budget Adjustment where funds already distributed to an Administrator program are reallocated to another initiative within that program.	X	X	X	X
3	Budget Adjustment for a program that is under budget where the amount under budget is moved to a contingency account.	X	X		X
4	Budget Adjustment for a program that is over budget where decisions are made on how to fund the overage either using available revenue or contingency.	X	X	X	X
5	Budget Adjustments between \$25,000 and \$200,000 that were referenced on a Staff Coordination Record. (Attach the Staff Coordination Record to the Budget Adjustment which reflects approval).	X	X		X
6	Budget Adjustments over \$200,000 (Attach the Board Agenda Item which reflects approval).	X	X		X
7	Budget Adjustments to reallocate funds within a project/initiative.	X	X		
8	Budget Adjustments in the District Building Fund (Fund 0353).	X	X		X
9	Revenue Adjustments under \$200,000.	X	X		
10	Revenue Adjustments over \$200,000.	X	X		X

Division and Department Information



DIVISION RESPONSIBILITIES

The Georgia Constitution requires that an elected board of education oversees each public-school system. The Cobb County School District is governed by a seven-member board; each member is elected by the public and serves a four-year term. The Board appoints a Superintendent of schools to serve as the Chief Executive Officer (CEO). The Superintendent is responsible for implementing educational programs and running the day-to-day operations of the school district.

DIVISION ORGANIZATION

The Superintendent's Division is sub-divided into functional areas of responsibility. The following chart illustrates the structure of this division:

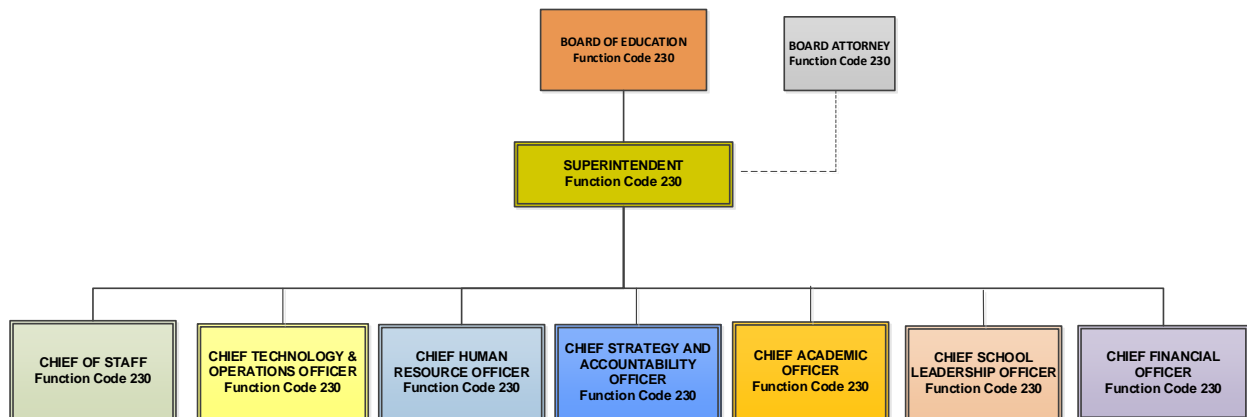

MAJOR DEPARTMENT TASKS

Board Attorney - Each year the Board retains the services of an external attorney to provide legal advice and to handle legal matters for the school district.

The **Chief of Staff, Chief Strategy & Accountability Officer, Chief Human Resources Officer, Chief School Leadership Officer, Chief Academic Officer, Chief Technology & Operations Officer, and Chief Financial Officer** assist the Superintendent in supervising all activities and operating functions of the school district.

WORKLOAD INDICATORS

INDICATOR	FY 2020 RESULTS	FY 2021 RESULTS	FY 2022 RESULTS
Board Meetings - Meet once per month with a day Work Session and an evening Voting Session	12 Board Meetings	12 Board Meetings	12 Scheduled Board Meetings
Local School Principal Advisory Council - Six members from each school provide advice and recommendations to the principal and, as appropriate, to the Board.	Most schools have school principal advisory councils. Each council contains: 2 teachers 2 parents 2 business representatives and the principal.	Most schools have school principal advisory councils. Each council contains: 2 teachers 2 parents 2 business representatives and the principal.	Most schools have school principal advisory councils. Each council contains: 2 teachers 2 parents 2 business representatives and the principal.
Facility & Technology Committee – 15 appointed members (1 by the Superintendent and 2 per Board Member) meet to oversee the SPLOST spending.	4 F&T Committee Meetings were held in FY2020. Meetings are held quarterly.	4 F&T Committee Meetings were held in FY2021. Meetings are held quarterly.	4 F&T Committee Meetings were held in FY2022. Meetings are held quarterly.
Superintendent’s Principal Advisory Council – 12 appointed members by level assistant superintendents.	Due to the COVID-19 Pandemic, only 2 meetings were held during FY2020	Due to the COVID-19 Pandemic, 4 virtual meetings were held during FY2021	4 scheduled Leadership & Learning meetings were held during FY2022
Superintendent’s Teacher Advisory Council – 14 appointed members by level assistant superintendents from pool of current Teachers of the Year.	Due to the COVID-19 Pandemic, only 2 meetings were held during FY2020	Due to the COVID-19 Pandemic, the Superintendent did not meet with this advisory group during FY2021	Due to the COVID-19 Pandemic, the Superintendent did not meet with this advisory group during FY2022
Business and Community Advisory Committee – 14 members appointed by Superintendent.	Due to the COVID-19 Pandemic, only 2 meetings were held during FY2020	Due to the COVID-19 Pandemic, the Superintendent did not meet with this advisory group during FY2021	The Superintendent met with this advisory group 3 times during FY2022

DIVISION RESPONSIBILITIES

- Ensures effective operations of the Superintendent's Office;
- Provides comprehensive support to assigned areas;
- Provides strategic communications counsel to the Superintendent;
- Serves as a credible representative of the Superintendent within the district, in the community, and at state and national levels.

DIVISION ORGANIZATION

The Chief of Staff Division is sub-divided into functional areas of responsibility. The following chart illustrates the structure of this division:

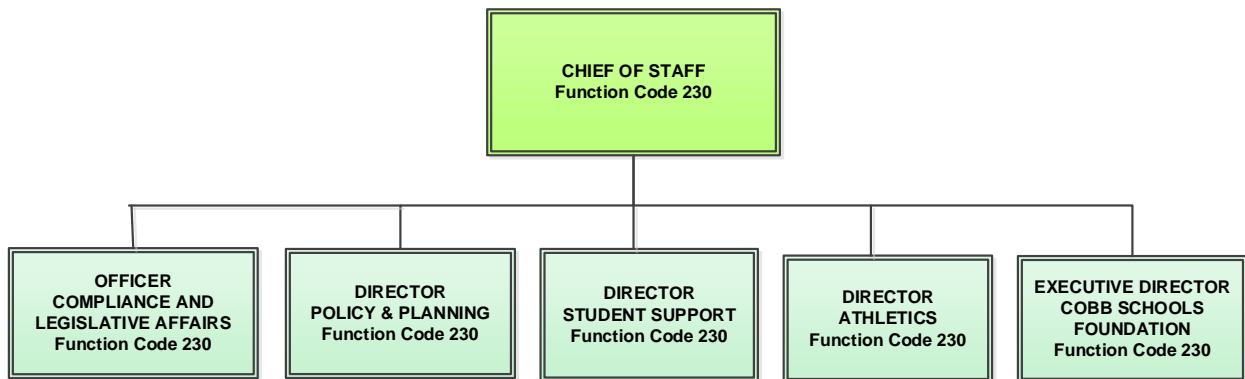

MAJOR DEPARTMENT TASKS

Policy and Planning – Policy and Planning is responsible for the development, interpretation, and implementation of Board Polices and Administrative Rules in addition to handling issues such as student transfers, student record requests, subpoenas, and open records, and serving as the District's Title IX office.

Policy Development:

- Development, coordination and distribution of Board Policies and Administrative Rules
- Contact for school administrators for interpretation and implementation of Board Policies and Administrative Rules
- Maintaining on-line policy manual

Planning:

- Calendar Development
- School Choice Transfers
- Hardship Transfers
- Children of Employee Transfers
- Reports to the Board

Open Records:

- Open Records requests
- Subpoenas
- Request for the Production of Documents
- Assist local schools regarding FERPA requests

Title IX:

- Title IX Investigations

Student Support – Student Support serves as the legal liaison for student discipline, enrollment, custody, and guardianship issues as well as general student discipline issues. Other responsibilities include School Health Services and School Social Work.

Student Support:

- Student Enrollment
- Guardianship
- Custody Issues
- Contact for school administrators on Code of Conduct interpretation and application
- Enrollment of students with discipline orders from other districts
- Legal Liaison for discipline issues
- Training for administrators participating in discipline hearings
- Monthly discipline summary reports

Student Discipline:

- Conduct student discipline due process hearings
- Review of suspension/expulsion letters
- Scheduling student due process discipline hearings
- Conduct student due process discipline hearings
- Preparation of Board appeal materials

School Health Services:

- Assess and manage acute illnesses, chronic health illnesses, and emergencies
- Provide direct care for medically fragile students
- Provide administration of medications (routine and emergency)
- Provide health education training for staff, students, and parents
- Orientation, training, and professional development of School Nurses and Clinic Substitutes
- Development, implementation, and interpretation of procedures and forms for clinic/student health
- Medical consultation for Section 504 plans for eligible students; RTI
- Collaborate with Cobb and Douglas Public Health and Georgia DPH, including surveillance of absenteeism and infectious illness
- Maintain clinic/student health data
- Oversight of immunization audit compliance
- Support student health and academic success by contributing to a healthy and safe school environment.

School Social Work:

- School Social Workers
- Community Resource Specialists
- DFCS Reporting
- Truancy Prevention Program

Community Relations - The Cobb County School District strives to maintain a positive, purposeful, and active relationship with the families of its students, and with the wider community in which it operates. We do this by working with the Parent Teacher Association (PTA), the Cobb Chamber of Commerce, civic organizations, local school councils, and other groups to build the community support vital to the success of our schools.

Athletics - The main task of the Athletics Office is to manage the interscholastic activity program in the Cobb County School System. The program provides opportunities for learning experiences in athletics which teaches attitudes of responsible team play and cooperation. It is also a vehicle for learning mental and physical self-discipline, loyalty, personal pride in the school, respect for the rights of others, and the will to win.

Cobb Schools Foundation - Founded in 1999, the Cobb Schools Foundation was established by a group of Cobb community and business leaders to enhance the mission of the Cobb County School District. An initial grant of \$1,000,000 from Cobb Energy was used to fund a portion of the athletic stadiums at Pope and Harrison High Schools, and used to build stadiums at Kennesaw Mountain and Kell High Schools. The Foundation is a nonprofit organization governed by a volunteer Board of Trustees separate from the Cobb County School District.

The Cobb Schools Foundation is dedicated to supporting, rewarding, and enhancing the schools, staff, and students of Cobb County School District by:

- Recognizing and rewarding excellence in teaching and learning
- Promoting innovative instruction through grants to our teachers and schools
- Ensuring a successful educational environment for all students
- Providing an opportunity for the community to actively contribute to public education

Compliance and Legislative Affairs – The Compliance and Legislative Affairs Office serves to ensure compliance with federal and state mandates and procedures while working with staff and community members to advocate for the legislative interests of the school board.

Legislative Priorities - Each year, the Cobb County School District meets with members of the Cobb legislative delegation to present its approved list of legislative priorities. With the variety of comprehensive issues related to state funding and school-related legislation, CCSD is well served by keeping local legislators apprised of important education issues.

WORKLOAD INDICATORS

INDICATOR	FY 2020 RESULTS	FY 2021 RESULTS	FY 2022 RESULTS
<u>Policy & Planning:</u>			
Policy/Rule/Form Revisions/ Creations/Deletions:			
Board Policies	1	7	1
Administrative Rules	20	65	8
Forms/Attachments	12	61	4
House Bill 251 Transfers:			
Requested	2,412	1,412	1,216
Selected/Approved	1,652	1,180	918
Administrative Transfers:			
Requested	327	76	485
Approved	145	48	127
Child(ren) of Employee Transfers:			
Requested	1,498	1,387	1,211
Approved	1,215	1,050	1,004
Continuation of Enrollments Transfers:			
Requested	1,064	1,272	1,713
Approved	809	1,105	955
Records/Subpoenas:			
Records Requests	53	25	39
Subpoenas for Records	40	23	26
Directory Information/Verification	29	24	15
Production of Documents	7	30	45
Other Record Requests	7	7	7
Open Records Requests: (9/15/15 – Open Records moved from Communications to Policy, Planning & Student Support)	382	339	508
<u>Student Support:</u>			
Student Discipline:			
Hearings	122	121	294
Hearings Waived by Parent/Guardian	175	107	179
<u>School Health Services:</u>			
Student Visits to the Clinic:			
Illness Visits	323,182	115,186	341,848
Injury Visits	130,923	45,621	126,516
Total Visits	454,105	160,807	468,364
Number of students remaining at School after Clinic Visit	292,647	143,568	260,406
School (Local) Medical Training:			
Total number of trainings provided by Consulting Nurses	199	330	190
Total number of school staff participants	5,358	6,956	6,313

INDICATOR	FY 2020 RESULTS	FY 2021 RESULTS	FY 2022 RESULTS
District Medical Trainings:			
Total number of trainings provided by Nursing Supervisor and/or Consulting Nurses			
• Online	56	150	102
• Face-to-Face	109	29	N/A
• Blended	14	38	8
Total number of school staff participants			
• Online	680	3,132	2,406
• Face-to-Face	2,972	712	N/A
• Blended	N/A	102	20
Professional Development Trainings:			
Preplanning/PLDs and other training provided by Nursing Supervisor and Consulting Nurses			
• Total of continuing education hours provided	2,378	1,163	944
• Total number of Nursing participants	1,972	1,568	1,394
• Number of Medical Training	21	24	34
Total number of school nurse participants Face-to-Face	258	N/A	240
Scoliosis Nursing Rescreens Referred to Physician	Info not available from Public Health	N/A Georgia DPH waived screenings during the 2020-21 school year.	Info not available as of 8/29/22 from DPH
Medical Healthcare Plans including Medical 504s	1,010	779	1,001
Significant Communicable Disease Data	COVID-19 Pandemic Measles Influenza epidemic Pertussis Scabies Varicella Fifth's Disease Strep, Staph Norovirus Impetigo	COVID-19 Pandemic Measles Influenza epidemic Pertussis Scabies Varicella Fifth's Disease Strep, Staph Norovirus Impetigo	COVID-19 Pandemic Measles Influenza epidemic Pertussis Scabies Varicella Fifth's Disease Strep, Staph Norovirus Impetigo Monkeypox

INDICATOR	FY 2020 RESULTS	FY 2021 RESULTS	FY 2022 RESULTS
School Social Work:			
New Cases Referred	8,448	5,284	12,288
Contracts/Services Rendered	58,491	31,578	76,960
Athletics:			
Number of GHSA Activities Participated	260	260	286
Number of Students Participated GHSA Activities	11,682	11,025	12,366
Cobb Schools Foundation:			
Local School Foundation Oversight	30	19	19
Local School Foundation Totals	\$365,300	\$465,488	\$459,166
Local School Assessment Total	\$8,100	\$15,213	\$18,286
Senior Scholarships Awarded (now included in Total Scholarships/Programs)	\$69,950	\$0	\$32,746
Total Scholarships/Programs	N/A	\$201,085	\$80,281
Gimme 5 (plus Unrestricted Funds)	Discontinued *	Discontinued*	Discontinued*
All In Campaign	N/A	\$29,721	\$46,588
Golf Tournament	Cancelled *	\$29,138	\$32,571
Teacher Grants Awarded	\$16,400	N/A	N/A
ASP Scholarships Awarded (Kids First)	\$5,261	\$17,041	\$17,041
Project 2400 Funding	Discontinued *	Discontinued*	Discontinued*
Reach for the Stars Funding	\$141,232	Discontinued*	Discontinued*
Volunteer of the Year Awards	\$20,297	Discontinued*	Discontinued*
Foundation Fund Balance	\$716,550	\$795,285	\$816,674
Compliance & Legislative Affairs:			
Due Process Filings	7	7	7
Resolutions	7	7	7
Hearings	1	1	1
Legislative Priorities			
Bills Requiring Action	23	23	23
Committee Presentations	6	6	6
Education Advocacy Meetings	21	21	21

*Temporarily discontinued or cancelled due to COVID-19 pandemic.

DIVISION RESPONSIBILITIES

The **Operations Division** is led by the **Chief Technology & Operations Officer**, comprised of departments that provide the District with services and support for daily operations, maintenance, transportation, public safety, business services, and SPLOST for the school system’s students, employees, and schools.

DIVISION ORGANIZATION

The Operational Support Division is sub-divided into functional areas of responsibility. The following chart illustrates the structure of this division:

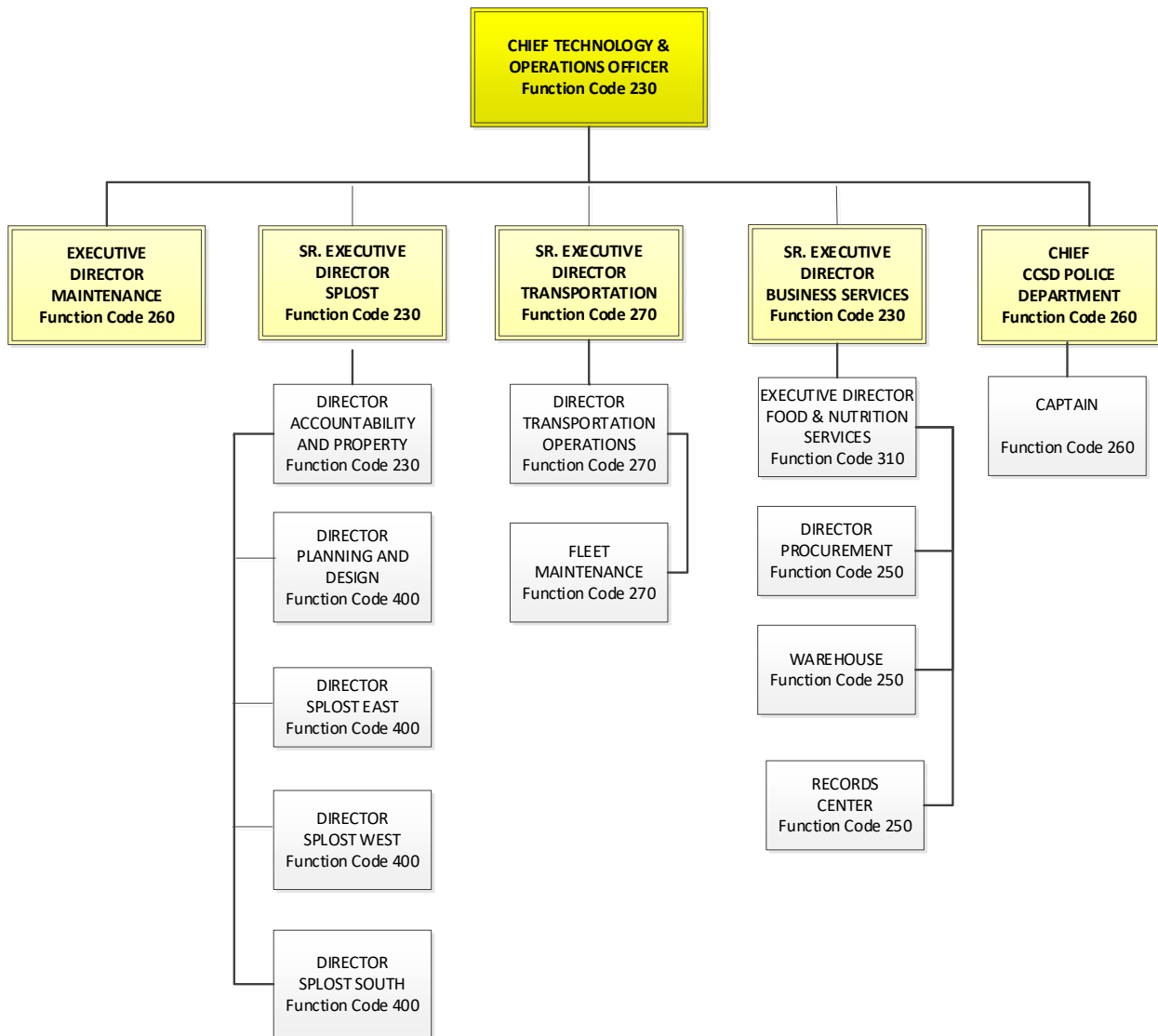

MAJOR DEPARTMENT TASKS

Chief Technology & Operations Officer is responsible for overseeing the services and support for the District’s Maintenance Services, CCSD Police Department, Transportation Services, Business Services and SPLOST Department.

The **Maintenance Services Department** provides this support through a staff of 15 administrators, supervisors, and clerical personnel in addition to a work force of 147 hourly employees. The department's primary objective is the maintenance of existing facilities, their grounds, and equipment not under manufacturer's warranty. These responsibilities involve 127 schools and support facilities that encompass 3,139 acres and 18,637,988 square feet throughout Cobb County.

The majority of support and repair requests submitted to Maintenance Services fall within the following areas:

- Heating and air conditioning
- Plumbing
- Electrical
- Paint touch-up
- Minor carpet and floor tile repair
- Security & fire alarm systems
- Intercom systems
- Custodial equipment
- Carpentry
- Roofing
- Grounds
- Glass replacement
- Keys and locks security
- Clocks
- Indoor environmental quality issues
- Kitchen and refrigeration equipment

Maintenance Services also supervises vendor contracts related to pest control, waste management, the cleaning of portables, elevator maintenance, fire extinguisher servicing, maintenance, research and installation of its equipment.

In addition, the department supports 628 custodians including evaluating their cleaning effectiveness, making equipment purchases, ordering supplies, training, and making recommendations in custodial shift staffing.

The **Transportation Services Department** employs over 1,100 professional school bus drivers, school bus monitors, fleet technicians, and support staff to provide safe and efficient transportation service to more than 70,000 riders of the District's eligible students each day. Our four fleet service centers maintain a fleet of 1,483 vehicles. The district has the second largest fleet of school buses in the state covering 38,533 bus stops daily. In FY2022, our school bus fleet traveled over 9,512,396 miles during an amended and shortened face-to-face instruction school year.

The District leads the state with our safety education program called S.O.A.R. (Safe, Orderly, And Respectful). The program educates elementary school students in a hands-on program as an at-school field trip, and middle school students in an assembly format. The Safe Rider Program is our student management program which assists in a safe ride and keeps students focused on safe bus riding behavior. Bus referrals have been reduced up to 55% since the program began in 2009.

All buses are equipped with telematics technology and digital video recording devices on the inside. The department will continue to offer air conditioning to all new school bus purchases as well as beginning a new program to embrace alternative fuels. We will utilize our SPLOST budget allocations as well as seek State and Federal funding sources to reduce the over 1,500,000 gallons of diesel fuel used annually. CCSD will not only start to see maintenance cost reductions, but also will reduce the amount of NOx emissions in our area.

Special Purpose Local Option Sales Tax (SPLOST) is a one-cent sales tax on all consumer goods that must be approved by Cobb County voters in a referendum. SPLOST revenues can be used only for specific school related capital outlay improvement projects. On March 21, 2017, Cobb County voters approved the **SPLOST V (2019-2023)** referendum that allowed for the continuation of the one-cent sales tax to fund a diverse list of school projects. Current **Ed-SPLOST V** will expire on December 31, 2023.

The SPLOST Department led by the Senior Executive Director of SPLOST, is responsible for all aspects of the planning, implementation, and completion of all SPLOST projects and activities. It is also the division's responsibility to monitor the bidding process to ensure design and construction stay within budget and the scope of the projects conform to the voter referendum.

Program managers coordinate the design of projects with consultants and local school administrators. It is also the responsibility of program managers to inform the community of planned improvements and solicit input on the plans during public forums held during the design phase.

Construction managers provide plan review and cost estimating services to the program management staff during design and manage the construction phase to assure on-time and on-budget project delivery.

Logistic managers are responsible for managing the purchase and installation of furniture, fixtures and equipment for new schools and addition projects. Logistic managers also provide coordination for project vendors, local school staff, central office administrators and other entities.

Director, Accountability and Property provides leadership and oversight related to the SPLOST department's financial transactions and property matters. Coordinates and oversees the management of the SPLOST budget and cashflow. Administers the management of growth and replacement requests. Participates in long term planning and program development. Assists in the development of school attendance zones. Liaison to the Cobb Board of Elections. Manages the District's communication towers and facilities agreements.

Director, Planning and Design facilitates and oversees the development of a quality management program (QA/QC) for the design phase of projects, as well as establishes and maintains project standards through oversight of CCSD design requirements and educational standards. Participates in long term planning and program development. Oversees and maintains the archive documents for all facilities. Administers the review and approval of FEAE-R projects. Assists in the selection and evaluation of design professionals and promotes communication/coordination across SPLOST departmental teams.

The **CCSD Police Department** is committed to serve our community, students and staff by providing a positive law enforcement presence. The Department enforces all laws in a fair and impartial manner to provide a safe and secure environment free from any obstruction of the educational process. Security programs are developed and maintained by the Department for all schools, school system facilities and property. Law enforcement officers are provided for the schools and they monitor overall safety of school campuses.

The **Business Services Department** is comprised of the departments of Procurement Services, Food and Nutrition Services, Warehouse Operations, Records Management, Mailroom and Courier Services and is a vital part of the Operational Support division of the Cobb County School District.

The **Procurement Services Department** works with schools and end-user departments to establish and maintain contracts for day-to-day supply and operational needs for the benefits of the educational process, accomplished through cost-effective, moral, ethical, and prudent purchasing practices. Procurement Services also handles construction (or capital project) solicitations. Assists schools and departments in purchasing goods/services not already on active contract and ensures that purchases of goods and services are consistent with public procurement principles and in compliance with District policies and applicable state/local/federal laws.

CCSD Food and Nutrition Services is responsible for providing nutritious meals daily for CCSD students and school staff in compliance with District policies as well as applicable local, state and federal guidelines. Meal service provided by FNS at each location varies, but may include breakfast, lunch and/or After School Program snacks.

Warehouse Operations manages the District’s internal mail collection and distribution as well as the disposal or redistribution of excess and surplus property. Responsibilities also include pick-up and delivery of testing and curriculum materials, maintaining a limited inventory of furniture for growth and replacement needs and assisting with textbook distribution.

The **Office of Records Management** is responsible for providing direction and coordinating the District’s records management plan including maintaining, archiving and appropriately disposing of CCSD student, staff, financial and other records.

Mailroom and Courier Services provide intra-District mailroom and delivery support for all Central Office departments and schools.

WORKLOAD INDICATORS

INDICATOR	FY 2020 RESULTS	FY 2021 RESULTS	FY 2022 RESULTS
Maintenance			
Building space sq. footage	18,583,402 for 127 Facilities	18,358,891 for 128 Facilities	18,637,988 for 126 Facilities
Work Orders (electrical, plumbing, roofing, floors, preventative maint., etc.)	51,744	45,659	47,124
CCSD Police Department			
Fighting	420	76	601
Drugs	126	3	76
Weapons	76	30	138
Gang-Related Incidents	12	1	7

WORKLOAD INDICATORS

INDICATOR	FY 2020 RESULTS	FY 2021 RESULTS	FY 2022 RESULTS
Transportation			
Number of students transported one - way	72,448	53,532	52,918
Ridership ratio	65%	49%	48%
Regular buses	821	806	802
Special Education buses	277	237	255
Bus stops per day	38,533	19,095	18,042
Field trips	3,584	1,688	3,377
Bus referrals	1,012	381	300
# of accidents	184	146	233
Fleet Maintenance			
Fleet	1,522 (1,098 buses)	1,473 (1,045 buses)	1,483 (1,059 buses)
Support vehicles	424	428	424
Bus fleet traveled	8,778,221 miles	5,795,481 miles	9,512,396 miles
Fuel usage	1,553,146 gallons	1,121,116 gallons	1,783,324 gallons
Fueling transactions	62,343	47,868	69,939
Buses serviced	All buses inspected monthly and annually	All buses inspected monthly and annually	All buses inspected monthly and annually
Average miles per bus	7,594	5,546	8,982
SPLOST			
# Projects started	9	43	41
# Projects completed	11	19	19
# ADA Projects	9	5	7
# Portables relocated	15	0	1
# FEAE-R Projects*	87	119	116
*(District property funded by others)			
Planning			
# Population growth survey conducted	0	0	1
# School attendance zone redistricted	4	3	3
# Land purchased (Parcels)	2	3	0
# Approved Easements	10	11	7
# Cell tower sites established	0	0	0

WORKLOAD INDICATORS

INDICATOR	FY 2020 RESULTS	FY 2021 RESULTS	FY 2022 RESULTS
Food Service Lunches	(134 serving days) *when students on-site	(170 serving days) *no charge meals after 9/1, with hybrid learning and meal kits	(177 serving Days) *no charge meals for all students for SY21-22
Full price meals served	3,423,200	16,415*	0*
Reduced price meals served	694,998	12,670*	0*
Free meals served	4,153,437	6,128,681	11,260,658
Adult & contracted meals served	239,827	143,432	207,716
Equivalent meals from extra sales	3,220,847	574,149	1,340,380
Elementary participation	83%*	54%	96%
Middle School participation	86%*	43%	90%
High School participation	68%*	28%	56%
Procurement Services			
Purchase orders processed	9,891	9,586	10,301
Dollar value of purchase orders	\$91,764,483	\$66,303,149	\$144,260,905
Average dollar per purchase order	\$9,277	\$6,916	\$14,005
Requests for Proposals			
Newly Issued and/or Awarded	18	27	38
Requests for Extension	43	47	46
Non-Awarded	4	1	2
Sealed bids			
Newly Issued and/or Awarded	42	23	40
Requests for Extensions	51	48	48
Non-Awarded	4	2	2
Quotes			
Newly Issued and/or Awarded	32	46	41
Requests for Extensions	25	33	42
Non-Awarded	4	7	6
Procurement cards	751	781	792
Dollar value of procurement card purchases	\$27,458,696	\$20,726,944	\$22,316,069
Total number of procurement card transactions	75,772	68,216	92,582
Average dollar per purchase	\$362	\$304	\$241
Warehouse Operations			
Total Surplus requests	2,116	2,317	2,639
Items picked up	32,953	34,565	48,759
Items delivered	22,480	30,420	35,782
Surplus Revenue (Net)	\$308,465	\$239,750	\$425,196
New Inventory Requests (OC)	175	383	181
New Inventory Shipped	5,419	18,432	4,426
New Inventory Value	\$371,516	\$291,200	\$308,051

INDICATOR	FY 2020 RESULTS	FY 2021 RESULTS	FY 2022 RESULTS
Records Management Center			
Record Movement Transactions	932	916	664
Transcript / Verification Requests	6,640	8,317	9,301
Carton of Records Retained & Managed	5,831	5,794	5,626
Records Center Revenue	\$44,652	\$53,994	\$60,662

TECHNOLOGY SERVICES DIVISION

SUBDIVISION RESPONSIBILITIES

Technology Services' mission is to provide the resources necessary to ensure all CCSD schools reach a consistent technology standard that enhances the teaching and learning process within each classroom through the effective use of technology. It also supports the operation of the District through the integration of all technologies for administrators, teachers, students, and parents. Major initiatives are led by Technology Services Departments which are Field Services, Network Services, Infrastructure Services, Instructional Technology, Information Systems and Project Management.

SUBDIVISION ORGANIZATION

The Technology Services Subdivision is divided into six functional areas of responsibility. The following chart illustrates the structure of this subdivision:

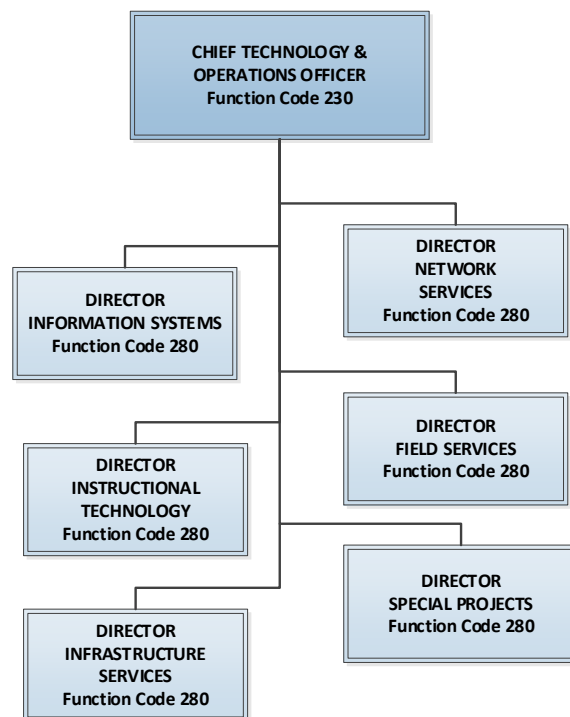

MAJOR DEPARTMENT TASKS

Technology Services' major tasks include the following areas:

Field Services – provides local school and administrative building support for Windows & Apple hardware (desktops and laptops) and software, local servers, printers, copiers, and interactive classroom devices. Also, the Lifecycle Management Team provides the administration and deployment of all software, maintains all software license compliance and usage statistics, manages mobile device integration, supervision and security, and creates and executes training of and support for technology throughout the District. These services include, but are not limited to software testing and approval, software updates, inventory maintenance, next level support, system management, vendor interaction, VPP integration, professional development, enterprise server support, online documentation, and protocol development.

TECHNOLOGY SERVICES DIVISION (Continued)

Network Services – provides centralized data center services and support for Directory Services, user provisioning, storage area networks, servers, core networking infrastructure, email and internet services, and Bring Your Own Device. Provides monitoring, reporting and prevention for enterprise network and data security anomalies and malicious activity. Also includes Business Continuity and Disaster Recovery services. Network Services collaborates with all District-wide departments and schools to provide input and resolution to many different types of technical initiatives.

Also included is the district's Customer Care Center (CCC) which receives first line support calls from all district employees, students and parents and escalates to other Technology departments as appropriate. The CCC may also support outside vendor or other parties as needed.

Infrastructure Services – is responsible for design, implementation and support of fiber optic cabling for Local Area Network and Wide Area Network in all existing, renovated, and newly constructed facilities. Installation and maintenance of all network equipment at all schools and administrative offices including all infrastructure cabling, switches, WAPs, Distance Learning devices and network closets. Support and maintain the District's audio-visual solutions as well as IPTV. Maintain Technology's Depot for hardware warranty, parts, and uninterrupted power supply (UPS) maintenance. Manage the District's telecom service, including VoIP telephones, servers, and Intercom systems at all sites. Manages the 30e dashboard for all hand washing stations. Manages the Centegix Crisis Alert system.

Instructional Technology – is responsible for assisting in the implementation and facilitation of District and local school technology initiatives; integrating 21st Century College/Career Readiness Skills for students into the K-12 curriculum; collaborating with District and local school personnel to provide professional development and strategic planning; partnering with the Cobb County School District (CCSD) Technology and Teaching & Learning Divisions to leverage technology for learning and student success; developing, coordinating, and/or delivering professional development programs utilizing District approved hardware and software to support the local school strategic plan and/or District strategic plan.

The InTech team supports teachers in effectively using technology to differentiate instruction, provide rigorous and engaging learning experiences, and ensure student success as demonstrated through student assessments. The InTech Team informs teachers/schools of emerging technologies and work cooperatively with classroom teachers to develop and implement effective instructional technology strategies and digital age learning environments. Team members model technology strategies when working with teachers and students to ensure appropriate technology integration and digital citizenship. InTech's goal is preparing all learners for success in a global, ever-changing society.

Information Systems – provides support, development, analysis, and training services for all District technology resources related to Student, Business, and District/local school website computer-based systems. For Student Systems, this includes support services for software that pertains to student enrollment, scheduling, grade book, attendance, assessment, discipline, health, federal & state reporting, and special education. In the area of Business Systems, the IS team maintains and supports the enterprise software for Financial Services and Human Resources/Payroll. The primary District websites, as well as each local school website, are developed, maintained, and monitored by the IS team. Information Systems provides custom development resources for web and mobile applications that cannot be served through purchased software. The department is also responsible for building and maintaining the District's Generation 3 data warehouse.

TECHNOLOGY SERVICES DIVISION (Continued)

Project Management – provides support, intervention, review and oversight for the District on all E-Rate processes and reimbursement request with USAC. Vendor management, administrative support, billing processes, payment request, data analysis and product management for all WAN, wireless telecom devices and land line telecom within the District. Operational telecom management for FirstNet wireless. Provides operational, administrative and budgetary divisional management reports to the Technology management team. Delivers special project services for product evaluations, RFP’s, Bid’s, training or other technology initiatives. Responsible for the planning, initiation, execution, monitoring and completing of CCSD approved technology initiatives.

WORKLOAD INDICATORS

INDICATOR	FY 2020 RESULTS	FY 2021 RESULTS	FY 2022 RESULTS
Technology Services			
<ul style="list-style-type: none"> Total number of instructional computers supported, total number of administrative computers supported (based on Georgia Dept. of Education Report) 	102,864	104,296	136,623
<ul style="list-style-type: none"> Total computers in district 	102,864	104,296	150,170
<ul style="list-style-type: none"> Total servers in district 	993	1,024	1,017
<ul style="list-style-type: none"> Total number of phone lines in schools 	2,094	2,137	2,100
Number of service requests handled by Service Center staff (help desk) annually	59,395	71,294	83,442
Number of e-mail accounts	134,947	145,750	141,582
Average availability for IT Data Center resources	99.77%	99.98%	98.59%
Ratio of Instructional Tech personnel per school	5:112	5:112	5:112
Number of schools receiving interactive devices from SPLOST IV & V	112	112	112

DIVISION RESPONSIBILITIES

Human Resources' goal is to attract, employ and retain the most qualified applicants for all school district positions and to improve delivery of services rendered by the division to all applicable groups and individuals.

DIVISION ORGANIZATION

The Human Resources Division is sub-divided into five functional areas of responsibility. The following chart illustrates the structure of this division:

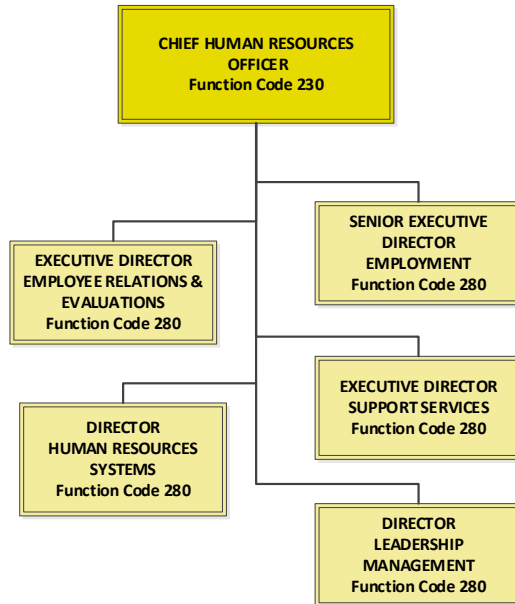

MAJOR DEPARTMENT TASKS

Under the Chief Human Resources Officer's supervision, the Human Resources Division has the following Departments and Offices provide services to District employees and prospective candidates for employment.

The Employment Department encompasses several functions including: **Employment, Teacher Recruitment, Compensation & Certification, Absence Management, and Student Teachers.**

Employment directs the employment activities for over 18,000 full-time, part-time, and temporary Classified and Certified employees (excluding Administrators). Primary responsibilities include receiving job requisitions and posting job vacancies to the website, supervising the application, directing the employee transfer and reassignment procedures; managing the daily operations of employment, problem solving HR issues with school and central office administrators which require a thorough knowledge of HR policies, law and practices; processing resignations and retirements; developing a recruitment strategy and providing substitute teacher training and support to local schools; issuing employment contracts to all Certified Employees.

Teacher Recruitment The office builds relationships with schools to recruit future educators and to coordinate student teachers. HR hosts Recruitment Fairs in multiple campuses. For FY2022-2023, over 7,000 certified instructor contracts were issued, and 98% of Cobb school educators signed up to teach in the new school year. The numbers reflect that Cobb County Schools continue to be the best place to teach, lead, and learn.

Compensation & Certification is responsible for ensuring pay structures and incentives are designed to compensate employees for their skills, abilities, performance and years of experience. This includes evaluating experience and certification documents for step placement; processing employee transfers, reassignments and terminations; developing and rolling out incentive programs; updating employee work calendars; administering salary increases and revising salary schedules; conducting job evaluations and approving job descriptions; and managing salary surveys to ensure salary rates are leveraged competitively. Provides guidance to all employees on laws and district policy.

The District's goal is to have a compensation program that attracts, retains, and motivates a highly qualified and competent work force, and to provide employees with a total compensation plan that is competitive with other school districts.

The department is also responsible for managing the certification process for educators, service professionals, and paraprofessionals including initial certification, renewals and upgrades; ensures certified staff meet requirements of Georgia Department of Education ESSA requirements; and reporting all district staff to the Georgia Department of Education through the Certified/Classified Personnel Information (CPI) collection.

The Human Resources Systems Department encompasses several functions including: **HR Technology, Employment Verification, and Records.**

HR Systems (Technology) is responsible for supporting and implementing information systems and processes to ensure the easy management of human resources, business processes, and data. Systems and processes supported are inclusive but not limited to:

- Support of Applicant Tracking System (ATS, TalentEd, Applicant Tracking Enterprise), as well as related processes and data collection.
- Responsible for support of the MUNIS ERP software's HR modules and all involved HR processes.
- Responsible for Document Management system (aXs, PowerSchool's Employee Records) functionality, data maintenance, and processes.
- Responsible for producing HR data reports and high-level data maintenance.
- Support of all HR related system interfaces to ensure proper transfer of HR related data and content.

Records manages the storage and maintenance of employee personnel records, employment verification and responds to requests for information in compliance with the Georgia Open Records Act.

The Support Services Department encompasses several functions including: **Workplace Accommodations, Benefits/Leaves, Retirement, and Risk Management**

Benefits is responsible for the District's comprehensive employee benefits program which includes requesting and evaluating bid proposals for each type of coverage; providing benefits education to new and existing employees; assists with the enrollment process for new hires, assists with status changes, and the open enrollment process; counseling and processing paperwork for retiring employees; managing the Cobb County School District Retirement Plans; coordinating the Catastrophic Illness Leave Bank; managing leaves of absence and responding to employee needs by email, phone and in-person visits. The Benefits Office is also responsible for the payroll deductions associated with all employee benefits; for the collection of payments missed due to unpaid leaves of absence; and for making payments to insurance companies and state agencies for employee benefits. Currently, the Benefits Office administers the following:

State Health Benefit Plan	Dental Insurance
Teachers Retirement System of GA	Vision Insurance
Public School Employees Retirement System	Legal Services
CCSD Retirement Plan	Accident
Board Pay Life Insurance	Hospital Indemnity
Board Pay Long Term Disability	Flexible Spending Account
Short Term Disability	Dependent Care Account
Voluntary Life/ADD	Critical Illness/Cancer
Spousal Life	Spousal C I/Cancer
Child Life	Child C I/Cancer
Catastrophic Illness Leave Bank	Leaves of Absence

Risk Management protects the people and assets of the school district. The office coordinates bid proposals for property, comprehensive crime, and student accident insurance. It also administers the Districts' self-insurance plan for general liability and vehicle accidents, including bus accidents. It receives and processes claims for student injuries, site visitors, and damage or loss to equipment and facilities. The District is self-insured and self-administered in the area of workers' compensation. Risk Management handles all aspects of the worker's compensation claims process. It is responsible for researching and responding to unemployment claims from the Department of Labor. Risk Management also addresses issues of loss control, safety, and accident prevention awareness.

The Leadership Management Department aims to match the available administrative talent (current Cobb employees and out-of-district applicants) to the needs of the District. It further assists the District in meeting the strategic and operational challenges facing it by having the right people in the right places at the right times to do the right things. The vision of Leadership Management is to create a deliberate and systematic effort by the District to ensure leadership continuity in key positions and encourage individual advancement.

Leadership Management in Human Resources directs the employment activities for all local school and central office administrative positions which include: supervising the application, employment, and orientation of all administrative new hires. It further facilitates the Principal Hiring Process and assists the District Leadership Division with the administrative reassignment process. Leadership Management is further responsible for the following:

- To provide a sufficiently large and diverse number of highly qualified candidates to fill local school and central office administrative openings
- Assist principals and central office administrators in their selection of leaders process
- Assist applicants, both internal and external, in completing administrative applications and understanding the system's leadership selection process
- Provide career counseling and guidance through informal office visits, as needed
- To help individuals realize their career objectives in administration
- Forecast replacement needs as a means of targeting necessary training, employee education, and employee development
- Direct the Leadership Academy application and selection process and coordinate the Educational Leadership Degree Program cohorts and partnerships

The Employee Relations Office coordinates investigations related to alleged employee violations of approved Board policies and procedures, State Board Policy, and other state and federal laws. Additionally, the Employee Relations office offers assistance to Administrators and Supervisors with local level investigations, job performance issues and the certified employee contract nonrenewal process and manages background checks and fingerprinting to ensure all employees of the Cobb County School District meet all the expectations provided by the Board. This office also manages the distribution of employee badges and assigns electronic access to all buildings in our district. The Office is responsible for the following areas:

- Employee disciplinary action, i.e. suspension without pay, demotion, termination
- Consultation with supervisors regarding employee job performance and misconduct issues
- Employee misconduct investigations
- Discrimination and sexual harassment investigations
- PSC Code of Ethics violations
- Certified employee contract non-renewals
- Employee complaints and grievances
- Labor relations issues
- Formal Employee Grievances
- Training regarding Employee Discipline and Documentation

The Evaluation Systems Office develops, facilitates, and monitors all evaluations for classified and certified employees. It is the point of contact for the Teacher Keys Effectiveness System (TKES), Leader Keys Effectiveness System (LKES) and the Cobb Keys Evaluation System for all certified and classified employees. As such, it manages the training process, ensuring all administrators are trained and credentialed on the evaluation systems for the District prior to the beginning of each school year. The Office also ensures all required training of administrators is up-to-date. In addition, the Office manages the daily administration of the employee evaluation system for all certified and classified staff, developing and updating all related training materials. The team reviews evaluations for compliance and accuracy to ensure consistent credibility and validity of evaluations. The team advises and consults with school and District Leadership including the Accountability and Research Department; the Leadership Office; and Technology Services, providing support with regard to all aspects of the TKES and LKES evaluation process.

WORKLOAD INDICATORS

INDICATOR	FY 2020 RESULTS	FY 2021 RESULTS	FY 2022 RESULTS
Certified Positions			
High School Hired	215	205	226
Middle School Hired	245	170	321
Elementary Schools Hired	356	258	551
Special Education Hired	223	108	116
Other Cert (Supervisors, Specialists, Social Workers)	14	34	94
Resignations / Terminations / RIFs	800	879	1,039
Supply Teachers	99	484	592
Certified Applications	54,102	37,367	48,216

INDICATOR	FY 2020 RESULTS	FY 2021 RESULTS	FY 2022 RESULTS
Classified / Paraprofessional Positions			
ASP Hired	325	137	283
Bus Drivers/Monitors Hired	232	111	135
Custodians Hired	116	71	177
Maintenance/Warehouse Hired	18	21	53
Food Service/Lunchroom Monitors Hired	239	57	365
Classified Subs Hired	293	283	715
Paraprofessionals/Tutors Hired	270	133	255
Clerical Bookkeepers Hired	70	45	130
Professional/Technical Hired	12	17	40
Nurses Hired	21	11	23
Campus Police Hired	4	5	10
Interpreters Hired	3	4	9
Other Employment Changes	9,175	10,429	4,524
Resignations / Terminations / RIFs	1,082	2,001	2,146
Parapro Re-elects	67	69	215
Classified/Parapro Applications	43,687	23,574	22,915
Risk Management Claims			
Unemployment	1,786	912	217
Vehicles & general liability	544/49	84/41	456/51
Student/site visitor injuries	1,479	556	1,430
Student injured in transit	112	62	1
Workers Compensation	447	311	795
Property thefts	79	53	53
Evaluation Systems			
Elementary Summative Assessment TKES	N/A due to COVID	N/A due to COVID	N/A due to COVID
Middle Summative Assessment TKES data			
High Summative Assessment TKES data			
Leadership Management			
# Aspiring Leaders	19	19	24
# Securing position the following year	5 (26%)	5 (26%)	7 (29%)
<u>Administrative Positions</u>			
New Hire/Rehire	5	4	4
Promotion/Upgrade	72	40	45
Reassign/Transfer	87	29	36
Resign/Retire/Term	33	20	23
Critical Need Subs	21	20	10
Misc./Re-Elect	25	15	8
<u>Applications</u>			
Leadership Academy/New Administrator	4,109	3,008	3,491
Participants	187	83	78

INDICATOR	FY 2020 RESULTS	FY 2021 RESULTS	FY 2022 RESULTS
Insurance Enrollments			
Vol. Life Insurance/Spouse/Child	13,053	13,557	13,624
Dental Insurance: Metlife	10,062	10,003	10,075
Health Insurance:	Gold 1,196 Silver 1,542 Bronze 1,904 BCBS HMO 4,425 UHC HMO 399 KP HMO 1,513 UHC HDHP 270 Tricare 3 N/A	Gold 1,197 Silver 1,541 Bronze 1,942 BCBS HMO 4,413 UHC HMO 402 KP HMO 1,544 UHC HDHP 277 Tricare 2 N/A	Gold 1,325 Silver 1,528 Bronze 1,882 BCBS HMO 4,486 UHC HMO 278 KP HMO 1,544 UHC HDHP 283 Tricare 4 N/A
Cancer	9,708	8,972	8,874
Vision	8,488	8,003	8,438
Short-term disability	8,922	8,329	8,540
Legal services	2,810	1,873	2,225
Hospital	2,079	2,093	2,681
Accident	2,810	2,776	3,519
Critical Illness/Cancer (Added Benefits) Spousal C I/Cancer Child C I/Cancer	Updated Info n/a	Updated Info n/a	Updated Info n/a
Other Benefits			
Short-term leaves			
Long-term leaves			
Flexible Optional spending accounts	4,276	4,762	5,314
Retirements	352	407	367
Hospital Indemnity	2,120	n/a	n/a
Accident	2,852	n/a	n/a

STRATEGY & ACCOUNTABILITY DIVISION

DIVISION RESPONSIBILITIES

The Strategy & Accountability Division includes the following three key areas of responsibility: **Accountability, Research & Grants, the Office of Communications, and the Office of Events & Venue Management.**

DIVISION ORGANIZATION

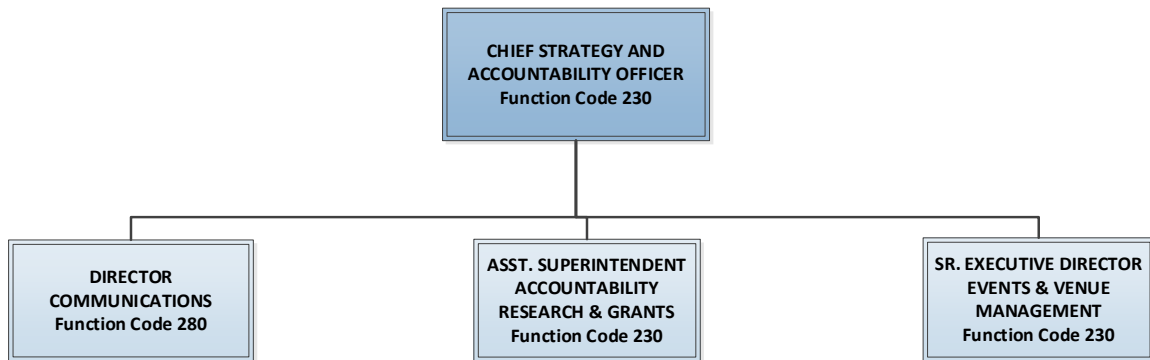

MAJOR DEPARTMENT TASKS

Accountability and Research – provides critical data, data analysis, and data interpretive training for all schools and District-level divisions to inform strategic planning.

The Office of Communications – assists schools with communications needs and promotes open and responsive communication between schools and their respective communities. In addition, the Office of Communications directs system branding and messaging, provides important information to stakeholders, and works daily with the media. The office aims to present a robust communications program that increases understanding of, commitment to, and advocacy for the school district and its mission and goals.

Events Services Office – handles the production of district events and live streaming broadcasts, oversees special locations such as the Lassiter Concert Hall, and is also responsible for the Facilities Use Office which coordinates with the CCSD Community to make meeting space available to the public.

Venue Management Office – responsible for working with non-profit community groups and sports organizations interested in scheduling activities in Cobb County School District facilities and/or on school grounds. While Cobb County School District's first priority is educating children, the District is aware of the importance of allowing community groups and sports organizations to use District facilities during non-school hours. This enables schools to be utilized to their maximum potential as groups adhere to guidelines set forth by the District.

ACCOUNTABILITY, RESEARCH & GRANTS SUBDIVISION

SUBDIVISION RESPONSIBILITIES

The **Accountability, Research & Grants Division** offers direction and support to all stakeholders by providing critical data, analysis, training, and research to improve student learning. These services support the District's vision, mission, and goals as outlined in the District strategic plan.

The Subdivision is comprised of five major departments: **Accountability, Alternative Education Programs, Cobb Virtual Academy, Accreditation and Continuous Improvement.**

SUBDIVISION ORGANIZATION

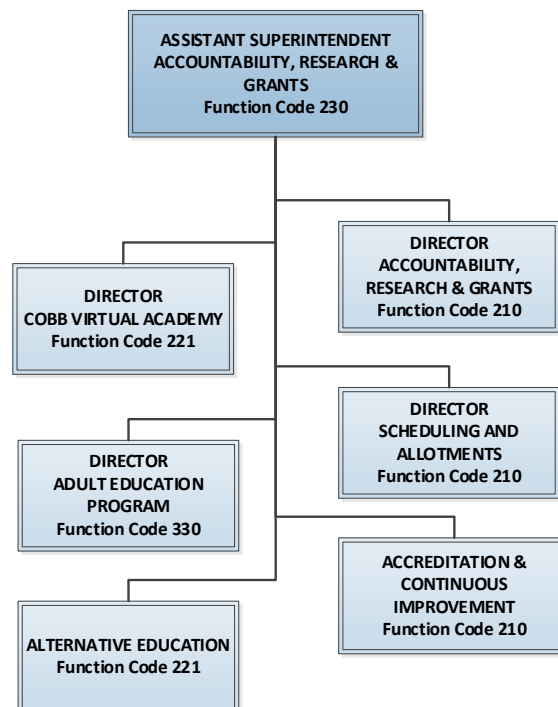

Accountability Department

The Accountability Department provides critical data, data analysis, and data interpretive training for all schools and District-level divisions to inform strategic planning. There are five major areas within this department:

- **State and Student Reporting** – oversees the reporting of student data to the Georgia Department of Education (GaDOE) and the federal government. Student data accuracy impacts funding, teacher allotments, and school and state accountability measures. The department provides training on data accuracy and posts updated web-based resources for school use.
- **Data Processing and Analysis** – processes and reports data from stakeholder surveys, state-required accountability data, district trend data, assessment data, and demographic data. It analyzes data sources and trends to inform parents, schools, the School District, and public agencies. It also assists with data needed for Program Evaluation and District Strategic Planning.

ACCOUNTABILITY, RESEARCH & GRANTS SUBDIVISION (Continued)

- **Scheduling and Allotments** – develops and implements the allotment allocation process for school-level positions and for maximizing utilization of those allotments through strategic master scheduling at the elementary, middle and high school levels. Professional learning is provided to administrators, local school support staff, and central office staff to support and improve the allotment and scheduling processes. By developing innovative and intentional scheduling models that make the most of staffing resources, Scheduling and Allotments works with local school leadership to design a framework to support the greatest possible learning outcomes.
- **Research and Grants** – stewards federal, state, corporate and private grants to support the education needs of the District. Working in tandem with District leadership and the talented efforts of teachers and school administrators, the Cobb County School District has been awarded many grants that have provided innovative programs impacting all students. Additionally, the District receives numerous requests for conducting educational research within the District which are processed according to specified District criteria for approval.

Alternative Education Programs Department

- **Ombudsman Program** – provides a means for students to receive educational services for those who have personal, social, learning, family and environmental challenges that make it harder for them to be successful in a traditional classroom setting.

Ombudsman blended learning approach allows teachers to include technology in their work with individual students and small groups. As a result, students and teachers develop richer, deeper positive interactions and students develop self-confidence. Flexible sessions allow time for family, friends, work, and school. The Program locations in the District include East Cobb, Mableton, and Powder Springs.

- **Adult Education** – teaches adult students the literacy skills necessary to become productive, responsible, well-adjusted members of the community thus improving the quality of life for all Georgians. In order that all students realize their full potential, our mission is to marshal resources and use relevant curriculum to provide education and a supportive, yet challenging, environment that allows for individual, self-paced instruction.

Cobb Virtual Academy

- **Cobb Virtual Academy** – The Cobb County School District is a leader in the integration of technology to provide improved educational opportunities for students. Cobb Virtual Academy is an integral part of this leadership. Completing a meaningful online learning experience allows students to become familiar with key means of increasing their learning skills and knowledge. It will also prepare them for the demands that they will encounter in higher education, the workplace, and in personal life-long learning. While students informally develop technology skills and gain experience through their media rich lives, an online learning experience will require them to complete assignments, meet deadlines, learn appropriate online behavior, and effectively collaborate with others in an instructional setting. In accordance with the Georgia Virtual School legislation signed by the Governor in May 2005, Cobb Virtual Academy offers online courses to students as part of the regular school day. In July 2012, Senate Bill 289 was enacted guaranteeing students the opportunity to take online courses.

ACCOUNTABILITY, RESEARCH & GRANTS SUBDIVISION (Continued)

Cobb Virtual Academy offers high quality, Internet-delivered core high school courses that equip CCSD students to thrive in the complex life and work environment of the 21st Century. Cobb Virtual Academy is an online program that works directly with students and delivers online courses. CVA is not a school -- it is a supplemental program serving students currently enrolled in CCSD schools. Online courses provide a full course education experience in which instruction takes place primarily over the internet, using an online delivery system to provide access to course content. It may be accessed from multiple settings (in school and/or out of school buildings). In this virtual online environment, students follow a course schedule to complete a combination of assignments, tests, quizzes, projects, and assessments that permit a teacher to follow the educational progress of the student. CVA courses are led by certified teachers and the grades earned become part of the student's academic record. All courses are NCAA certified and meet national, state, and Cobb County School District curriculum standards.

In addition to rigorous course content that meets state and district performance standards, Cobb Virtual Academy's online learning environment fosters creativity, critical thinking, communication, and collaboration, as well as mastery of information, media, and technology skills--all of which are essential for preparing students for the future.

Accreditation and Continuous Improvement Department

- **Accreditation** – facilitates the process for on-going District accreditation through Cognia (formerly AdvancEd). It ensures that the Cobb County School District maintains accreditation by overseeing adherence to these international standards and movement towards exceptional status.
- **Continuous Improvement** – manages the ongoing strategic planning process that is critical in every organization. Continuous Improvement develops the process for District strategic planning to ensure that all critical priorities facing the school district are addressed and the planning process is aligned at the local school level. It monitors strategic plans of local schools and divisions at the central office to ensure that key actions are aligned to District priorities, measurements are valid, and results are annually reported to all stakeholders.

ACCOUNTABILITY, RESEARCH & GRANTS SUBDIVISION (Continued)

WORKLOAD INDICATORS

INDICATOR	FY 2020 RESULTS	FY 2021 RESULTS	FY 2022 RESULTS
Adult Education			
Students served	1,433	691	920
Cobb County	469	335	414
(ESOL)	743	217	347
Paulding County	216	126	159
Cobb County Correctional inmates	5	13	0
Number of students taking GED	183	187	233
Number of students taking GED that received the credential	85	35	47
Alternative Education Program			
ESOL Department (Students Served)	11,726*	11,725*	12,923*
Ombudsman	331	174	381
		(CCSD students had the choice of Remote learning or F2F Learning)	(CCSD students had the choice of Remote learning or F2F Learning)
Scheduling & Allotments (FTE Growth)			
All EIP	+8%	+5%	+1.6%
Gifted	+4%	+3%	+3%
REP	+7%	+3%	-2%
Estimated increase in state funds (Cycle 1) for identified programs over Previous SY	\$17,913,945	\$4,397,064	\$3,075,411
All Calculations based on GADOE Earnings (Allotment) Sheets			

Sources:

*Student Record SR025a report – ESOL now under Academics.

ACCOUNTABILITY, RESEARCH & GRANTS SUBDIVISION (Continued)

INDICATOR	FY 2020 RESULTS	FY 2021 RESULTS	FY 2022 RESULTS
<p>Cobb Virtual Academy</p> <p>Courses available on-line to students</p> <p><i>* Each unit represents 1/2 credit, restated to include unique courses</i></p>	<p>Cobb Virtual Academy</p> <p>41 course offerings</p> <p>4,500 students</p> <p>17 High Schools</p> <p>2 Special Schools</p> <p>23 Middle Schools</p> <p>5,000 FTE units*</p> <p>4,450 tuition units</p> <p>Blended Learning</p> <p>Support for blended learning now under Teaching & Learning/CTLS</p> <p>Georgia Virtual School</p> <p>1,891 Students</p> <p>17 High Schools</p> <p>22 Middle Schools</p> <p>1 Special Schools/Programs</p> <p>119 course offerings</p> <p>3,121 FTE units</p> <p>1,201 Tuition Units</p>	<p>Cobb Virtual Academy</p> <p>41 course offerings</p> <p>4,000 students</p> <p>17 High Schools</p> <p>2 Special Schools</p> <p>23 Middle Schools</p> <p>4,500 FTE units*</p> <p>3,300 tuition units</p> <p>Blended Learning</p> <p>Support for blended learning now under Teaching & Learning/CTLS</p> <p>Georgia Virtual School</p> <p>1,408 Students</p> <p>17 High Schools</p> <p>14 Middle Schools</p> <p>1 Special Schools/Programs</p> <p>119 course offerings</p> <p>2,317 FTE units</p> <p>998 Tuition Units</p>	<p>Cobb Virtual Academy</p> <p>44 course offerings</p> <p>4,009 students</p> <p>17 High Schools</p> <p>2 Special Schools</p> <p>23 Middle Schools</p> <p>5,133 FTE units*</p> <p>3,784 tuition units</p> <p>Blended Learning</p> <p>Support for blended learning now under Teaching & Learning/CTLS</p> <p>Georgia Virtual School</p> <p>1,480 Students</p> <p>17 High Schools</p> <p>14 Middle Schools</p> <p>1 Special Schools/Programs</p> <p>125 course offerings</p> <p>2,818 FTE units</p> <p>810 Tuition Units</p>

ACCOUNTABILITY, RESEARCH & GRANTS SUBDIVISION (Continued)

INDICATOR	FY 2020 RESULTS	FY 2021 RESULTS	FY 2022 RESULTS
SAT Scores ¹			
Cobb	1,107	1,150	1,111
Georgia	1,043	1,077	1,052
National	1,030	1,038	1,028
% Tested	n/a	n/a	n/a
Number of Seniors Tested	5,283	3,451	4,813
ACT Cobb Scores			
Composite	23.0	24.6	22.3
English	22.7	24.6	21.9
Mathematics	22.3	23.8	21.2
Reading	23.8	25.5	23.3
Science	22.6	24.1	22.1
Grants			
# competitive grants processed each year	23	36	91
\$ amount awarded for competitive grants	\$2,524,815	\$3,682,970	\$16,782,016
\$ amount awarded to include CARES funds	n/a	\$180,112,966	\$17,497,708
# Seniors*	8,532*	8,660*	8,661*
Number of graduates**	8,360**	7,886**	8,164**
Completion ratio	98%	91%	94%
K-12 dropouts***	2,192 ²	2,227 ²	2,546 ²
Research Applications			
# processed each year	90	77	86
Surveys Administered	Not Available††	Not Available††	Students: 22,332 Parent: 3,473 Staff: 2,918
% Schools Meeting CCRPI Requirements			
Elementary			
Middle			
High			
Total			
Schools Meeting the Strategic Waivers School Systems (SWSS) Evaluation System Requirements on CCRPI	Not Available††	Not Available††	Not Available††

Sources:

* FTE Cycle 1 FT002 report

** Student Record SR057A report

*** Student Record ENR019B report

² Student Record ENR019B report

†† Surveys not given and CCRPI not calculated in FY 2020 due to pandemic

COMMUNICATION SUBDIVISION

SUBDIVISION RESPONSIBILITIES

The Office of Communication produces content to communicate District priorities to the Cobb County community, directs system branding, and works regularly with media. In addition, the Office of Content and Marketing assists schools with communications needs and promotes open and responsive communication between schools and their respective communities.

SUBDIVISION ORGANIZATION

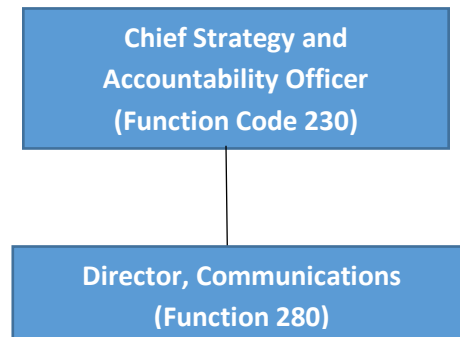

MAJOR DEPARTMENT TASK

The Office of Communications – tasked with a wide array of communications-related issues. Communications handles all incoming media requests from news outlets, supports all of our local schools as well as other departments in dealing with communications tasks, creates media across multiple platforms to market and support the district, and are intimately involved in ensuring that the Cobb County School District’s brand is promoted effectively and consistently across the county. The department develops messages intended for district-wide consumption and often assists local schools and departments in crafting consistent communications to best inform stakeholders.



COMMUNICATION SUBDIVISION (Continued)

WORKLOAD INDICATORS

INDICATOR	FY 2020 RESULTS	FY 2021 RESULTS	FY 2022 RESULTS
Communications			
Social Media			
Social Media “Impressions”	17,321,520	19,322,217	12,44,510
Social Media Engagement	1,156,069	1,974,585	602,984
Print Media			
Media Requests	655	771	850
Articles Published	580	340+	631
District Support			
School/District Support Requests	1,000+	1,000+	1,000+
Digital Media			
Videos Produced	86	84	96
Videos Managed for Others	53	15	16
Podcasts Produced	34	*0	*0
Video Impressions	1,197,354	1,536,290	1,847,106
CTLS Parent Messaging			
Emails Sent	7,605,722	40,827,326	35,800,185
Voice Calls Sent	201,422	1,112,256	12,661,037
Text Messages Sent	905,706	13,638,007	11,064,377
APP Push Notification	n/a	14,517,687	14,216,743
CTLS Parent Trainings	80	121	n/a
Attendance Clerk Trainings	23	38	n/a
CTLS & Attendance Trainings	103	159	226
Tech Tickets	n/a	585	337
Posts/Emails for CCSD Dept & Schools	n/a	462	400+

* Due to complications from COVID-19 and the limitations it placed on close contact in-person recording, no podcasts were produced during the previous year.



Cobb Schools Communications Department wins State Awards from The Georgia School Public Relations Association (GSPRA)

EVENTS & VENUE MANAGEMENT SUBDIVISION

SUBDIVISION RESPONSIBILITIES

The Events & Venue Management Department is responsible for planning, coordinating, and producing District events and coordinating facility space rentals to school groups, school support organizations, and third-party organizations. The department also manages the Lassiter Concert Hall.

- **Event Services** – Responsible for planning, coordinating, and producing corporate and public events and live streaming broadcasts. The scope of work includes managing events from conception through execution and includes, but is not limited to, securing venues, event design, attendee registration, catering, developing the run of show and script, furniture, décor; stage, audio, visual, and lighting, content development, and technical production.
- **Venue Management** – Responsible for scheduling, contracting, and coordinating use of schools and other District facilities by school groups, school support organizations, and third-party organizations for meetings, performances, athletic practices and games, and recreational activities. While Cobb County School District’s first priority is educating children, the District is aware of the importance of allowing community groups and sports organizations to use District facilities during non-school hours. This enables schools to be utilized to their maximum potential as groups adhere to guidelines set forth by the District.

SUBDIVISION ORGANIZATION

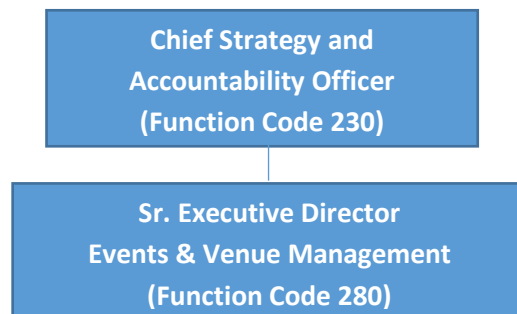

MAJOR DEPARTMENT TASKS

1. Plan, manage, coordinate, and produce events for the District in support of the vision, mission, strategic plan, priorities, goals, and objectives of the District.
2. Schedule, contract, and coordinate use of school and district facilities by school groups, school support organizations, and third-party organizations.

EVENTS & VENUE MANAGEMENT SUBDIVISION (Continued)

WORKLOAD INDICATORS

INDICATOR	FY 2020 RESULTS ^{1, 2, 3}	FY 2021 RESULTS ^{1, 2, 4}	FY 2022 RESULTS ^{1, 2, 8}
Event Services			
Streaming Events Produced	44	58	52
Strategic Events Produced	34	44	40
Virtual Events Produced	6	18	22
Signature Events Produced	27	19	6
Audience Attendance	30,504	57,571	82,136
Streaming Viewership	86,634 ⁵	156,654 ⁵	75,629 ⁵
District Events Supported ⁶	18	9	28
School Events Supported ⁶ (Audience Served)	26 (17,084)	7 (2,805)	30 (12,374)
INDICATOR	FY 2020 RESULTS	FY 2021 RESULTS	FY 2022 RESULTS
Venue Management			
Number of Contracts Executed	455 ⁹	140 ⁹	1,350 ¹⁰
Hours used by community organizations	11,115 ⁹	1,495 ⁹	19,496 ¹⁰
Revenue from facility rentals	\$756,198 ⁹	\$96,902 ⁹	\$1,387,415 ¹⁰
Net Revenue Distributed to Schools	\$62,035 ⁹	\$42,595 ⁹	\$510,138 ¹⁰
Concert Hall			
Hours used by community organizations	118 ⁷	118 ⁹	230
Revenue from community use	\$8,080 ⁷	\$8,080 ⁹	\$30,966
Hours used by school groups	312 ⁷	14 ⁹	570

¹ During FY2020-2021, COVID-19 resulted in the cancellation of some events and a move to virtual delivery of others, once it was clear that in-person events could not resume near-term. This also impacted audience attendance numbers.

² During FY2020-2021, COVID-19 forced the closing of school facilities for use by community organizations and school groups beginning March 13 and continuing through the end of the fiscal year.

³ High school commencements for the class of 2020 are included in these numbers even though they were conducted in July.

⁴ Continuing impacts of COVID-19 during FY2021 resulted in the cancellation of some events and a move to virtual delivery of others. This negatively impacted audience attendance numbers and increased virtual events/audience and streaming audience.

⁵ Streaming viewership does NOT include content delivered internally over IPTV, except for specific events where the viewers are gathered for viewing (such as the District Kickoff Broadcast) and can be quantified.

⁶ Supported events are those for which assets and/or personnel was provided to execute the event, but the Events Office did not have responsibility for planning and producing the event.

⁷ Construction on the Lassiter High School campus reduced the parking capacity which impacted both the school and Concert Hall functions and limited the use of the Concert Hall during FY2019 and FY2020 for both school and community groups, reducing revenue as well.

⁸ COVID-19, to a lesser degree, continued to have an impact on events during FY2022. While many events resumed, others still fell to cancellation. Virtual delivery options remained but were dramatically reduced. In-person audience attendance numbers rebounded while virtual events and streaming audience numbers declined.

⁹ COVID-19 resulted in decreased use of facilities and a decrease in revenue and net revenue distributed to schools.

¹⁰ A New District Administrative Rule approved in July 2021 and new contracts, funding models, fee rates, and processes implemented in the second quarter of FY2022 resulted in increased contracts and revenue and an increase in the net revenue distributions to schools. Schools previously received 30% of net revenue and now receive 100% of net revenue.

ACADEMIC DIVISION

Division of Academics

The Division of Academics is responsible for the foundation of teaching, learning, and student support services in Cobb County Schools. The two key subdivisions are the **Subdivision of Teaching & Learning** and the **Subdivision of Teaching & Learning, Support & Specialized Services**.

The foundational elements for Academics in Cobb County are built on clearly articulated teaching and learning standards, high quality instructional resources, effective and engaging instructional strategies, an infrastructure of formative assessments, and a District-wide student performance data collection mechanism by standard.

The strategy to advance teaching and learning in Cobb County, and the effort to ensure that the community recognizes that learning in a Cobb classroom is superior to any other educational option for our children, focuses on three priorities to guide teaching and learning in the district for the coming years.

Priority 1: Ensure that Cobb is the best place to teach, lead, and learn.

- Develop an infrastructure of Professional Learning Support accessible by all classroom teachers as aligned with their grade level/course area and pacing guides.
 - District-wide Face to Face Professional Learning Schedule Comprehensive Digital Staff Development Modules
- Identify, model, and communicate 21st Century Professional Learning Strategies
 - Collaboration/Any-time, Any-where Personalized Professional Learning
- Identify, promote, and support opportunities that recognize student achievement within and beyond the school/classroom
 - State Seals, competitions, certifications

Priority 2: Simplify and strengthen our foundation for teaching and learning to prepare for innovation.

- Clarify and communicate three components of teaching and learning (Standards, Learning Engagement Strategies, and Formative Assessment / Student Progress Monitoring)
- Bring balance back to mathematics, literacy, science, social studies, and extended core instruction
- Establish, model, and promote 14 research-based learning engagement strategies
- Advance evidence of STEM and STEAM in schools
- Facilitate pockets of innovation (i.e. STEM, HIP, Arts Integration, Dual Language Immersion, Problem-based learning)
- Facilitate school transformation models (i.e. Purpose, Learning Reconstruction, and Community Engagement)
- Develop innovative course models (i.e. embedded credit, distance learning, blended courses, etc.)
- Customize a content/resource acquisition strategy
- Learning Commons Transitions
- Prioritizing Standards to Address Unfinished Learning (Implemented 2021-2022 school year)
 - To address unfinished teaching and learning, prioritized learning standards were identified that systematically define teaching and learning expectations. Priority standards will serve as a companion guide to the existing instructional framework to support the continuous development of a district wide, comprehensive teaching, learning and assessment system.

ACADEMIC DIVISION (Continued)

Priority 3: Use data to make decisions.

- Fully develop the Cobb Teaching & Learning System (CTLs)
- Build an infrastructure of flexible formative assessment items and District-wide data collection process for student performance
- Administer a District-wide universal screener in math and reading in grades K-9
- Facilitate Math Fluency Initiative to build fact fluency and conceptual understanding in grades K-5
- Establish Early Literacy Framework to solidify foundational reading skills in grades K-3
- Identify student performance priorities
 - On-grade-level reading (at every grade)
 - Algebra success
 - HS graduation on time

The Academic Division includes the following two key areas:

Subdivision of Teaching & Learning and **Subdivision of Teaching & Learning Support and Specialized Services.**

DIVISION ORGANIZATION

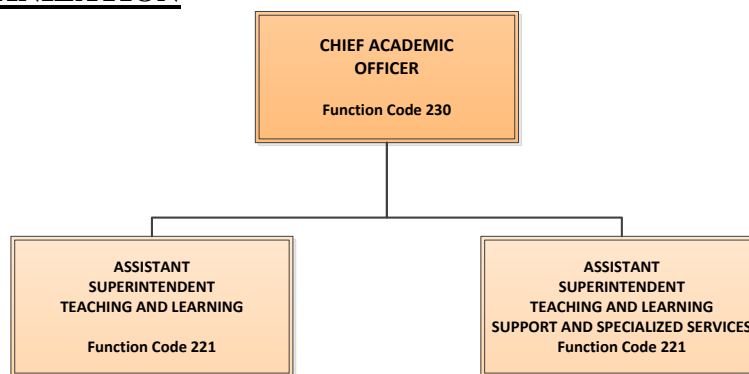

DIVISION RESPONSIBILITIES

The Division of Academics is responsible for the foundation of teaching, learning, and student support services in Cobb County Schools. The foundational elements for Academics in Cobb County are built on clearly articulated teaching and learning standards, high quality instructional resources, effective and engaging instructional strategies, and an infrastructure that establishes the necessary foundation for formatively assessing and monitoring student progress so that every student can be successful.

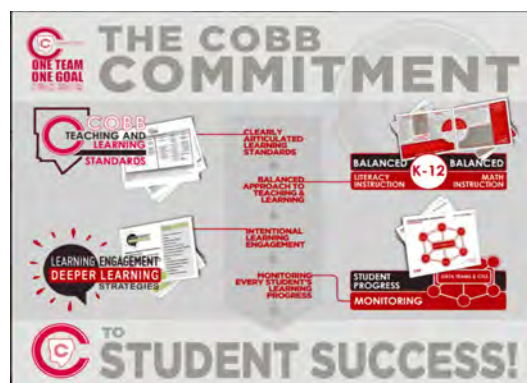

ACADEMIC DIVISION – TEACHING AND LEARNING SUBDIVISION

SUBDIVISION ORGANIZATION

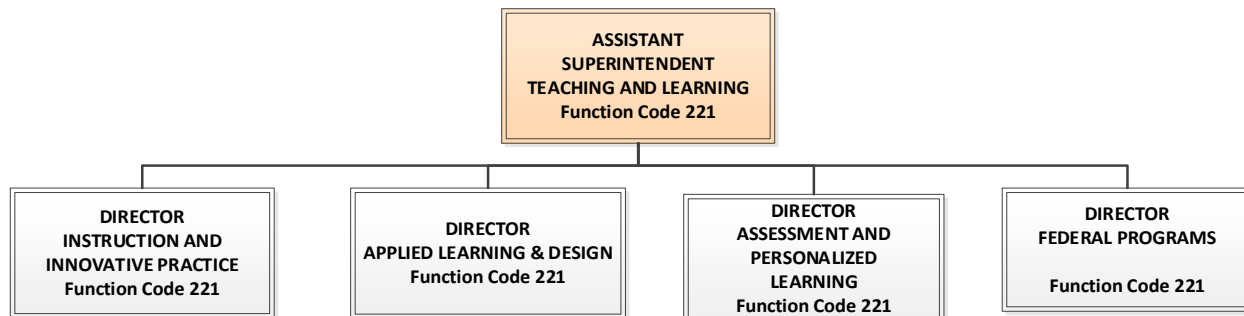

SUBDIVISION RESPONSIBILITIES

The Division of Teaching & Learning seeks to support and enhance the efforts of our schools, thus enabling students to perform at their highest levels of achievement. Contributing to the work of our division and influencing the teaching and learning process are our system’s mission, vision, core values and beliefs; our shared, instructionally focused leadership; our professional learning opportunities; and the input and support of our students, families, and community.

The Subdivision of Teaching & Learning consists of four Program Offices: **The Office of Instruction & Innovative Practice, the Office of Assessment & Personalized Learning, the Office of Federal Programs, and the Office of Applied Learning & Design.**

Instruction & Innovative Practice

- English / Language Arts
- Mathematics
- Science
- Social Studies
- Health & Physical Education
- World Languages
- Early Learning
- Professional Learning

Assessment & Personalized Learning

- Assessment, Elementary School
- Assessment, Middle School
- Assessment, High School
- Assessment, Student Growth Measures (or SGMs)
- Advanced Learning Programs
- Personalized Learning Programs

Federal Programs

- Title I
- Homeless Education Program
- ESOL, Title III
- IWC

ACADEMIC DIVISION – TEACHING AND LEARNING SUBDIVISION (Continued)

Applied Learning & Design

- Instrumental Music
- General Music, Choral, Theater, Dance
- Learning Design & Visual Arts
- Career, Technology & Agriculture Education
- STEM & Innovation
- Learning Resources
- Digital Transformation
- Library Media Education

Office of Instruction & Innovative Practice

The Office of Instruction and Innovative Practice is responsible for the fundamentals of academics in the Teaching & Learning Subdivision. There are eight departments in this office that reflect the academic programs of Cobb County: Mathematics, English Language Arts, Science, Social Studies, Health & Physical Education, World Languages, Early Learning, and Professional Learning.

Professional Learning seeks to provide opportunities for schools and the District to implement tools necessary for teachers to effectively teach their content in an engaging manner. Our Professional Learning Specialists work closely with local school leadership and teachers to offer consistent professional development relative to the specific content area they serve. The Office of Instruction & Innovative Practice is responsible for enhancing the instructional leadership capacity of all school leaders by articulating the teaching and learning standards in each content area, providing model resources (including frameworks), developing teacher leaders, facilitating professional learning, and providing principals and assistant principals support to ensure that effective instruction takes place in every classroom. Additionally, the Office of Instruction & Innovative Practice focuses on advancing the teaching and learning in Cobb Schools by thinking creatively about how instruction is delivered, how courses are developed and provided, and the strategies that are used in instruction. Our current priorities include:

- simplifying our foundation to prepare for innovation through a balanced literacy, math, science, social studies, health, physical education, and world languages approaches
- ensuring the content of the standards is delivered at high levels
- increasing learning engagement through implementation of research-based instructional strategies

The Office of Instruction and Innovative Practice provides teaching resources for classroom teachers and support personnel to incorporate into their planning for instruction. The resources are encompassed in CTLS Teach and include instructional frameworks, model lessons, unit plans, activities, videos, suggested tasks, and model assessments.

- Developing Innovative Academic Practices – The leadership staff in the Office of Instruction & Innovative Practice work closely with school leaders and classroom teachers to develop ideas for how to expand and transform learning for today’s students. This includes innovative instructional strategies, unique uses of physical spaces, technology integration, and innovative course design (i.e. embedded credit, accelerated pacing, creative scheduling models, etc.).
- Enhancing Instructional Leadership Capacity of School Leaders – As the District’s experts in research, national successes, teaching and learning standards, and effective instructional strategies, the leadership staff in the Office of Instruction and Innovative Practice collaborate with District leadership, principals, assistant principals, and teacher leaders on what engaging instruction looks like for their program areas. This may include walking classrooms with leaders, suggesting available training and support, as well as conversations about the teacher evaluation system and its standards.

ACADEMIC DIVISION – TEACHING AND LEARNING SUBDIVISION (Continued)

Additionally, this office leads and supports professional learning designed to advance teacher effectiveness, to mobilize school improvement efforts, and to develop and sustain a culture of continuous growth and improvement. Teachers engage in professional development opportunities that help them deepen their content-specific knowledge and skills and learn new strategies that support the art and science of teaching. The District is committed to an improved infrastructure of professional learning that has been expanded to guarantee that every Cobb educator has equal access to quality professional learning aligned to their grade level, course area, and pacing guide for instruction.

All teachers are provided professional learning opportunities to learn more about instructional practices in their specific subject areas and support the areas measured on the TKES system. These trainings are offered systematically in a series of face-to-face and/or virtual sessions. Professional learning opportunities are provided at the District level and at the local school level.

School-Focused Professional Learning Programs are job-embedded experiences designed to improve student performance connected to the growth areas identified in the individual school's strategic plan. The Office of Instruction and Innovative Practice leaders provide consultative support to school leaders in the design and implementation of these professional learning interventions. Many school plans have teachers working in Cobb Collaborative Communities (or CCCs) that focus on improving teacher practice and increasing student achievement.

District courses, such as endorsements, are provided to meet the diverse professional learning needs of Cobb staff and to address specific District goals and program areas. The Professional Learning Department staff manages a web-based portal for the course catalog, online registration, and documentation.

WORKLOAD INDICATORS

INDICATOR	FY 2020 RESULTS	FY 2021 RESULTS*	FY 2022 RESULTS*
Professional Learning			
# PL offerings	564	1,262	1,372
-ESOL			112
# Participants	8,606	8,834	11,166
-ESOL & Title III			3,577
Teacher Leader Academy	188	155	144
# Endorsements earned	244	302	301
- Gifted	158	173	166
- TSC	29	24	24
- TLE	16	22	10
- ESOL	29	71	70
- Math	12	12	31

***Note:** The data source prior to FY2020 was generated from district professional learning days. For FY2021 and beyond, the data has been changed to reflect professional learning across the Academic Division (6 offices).

Office of Assessment & Personalized Learning

The mission of the Office of Assessment and Personalized Learning is to increase personalized learning opportunities, to increase advanced learning opportunities, to facilitate the administration of national, state, and District assessments, and to build leadership capacity of school leaders to advance assessment practices and the use of data to inform instruction. Our current priorities are:

- Local, State, and National Standardized Assessments
- Formative Instructional Practices
- Universal Screener
- Cobb Teaching & Learning (CTL) Assess
- Response to Intervention (RTI) and Cobb Systems of Support
- Advanced Learning Programs

This Office includes the departments of Assessment, Personalized Learning, and Advanced Learning Programs.

The **Assessment Department** is responsible for facilitating the administration of national, state, and local assessments across the District. The department works collaboratively with teachers, school administrators and curriculum leaders to develop district assessments and improve assessment literacy across the District. Additionally, the Assessment Department leads and supports professional learning designed to advance teachers' and administrators' understanding of assessment strategies and uses. This includes the facilitation of the Cobb Teaching and Learning System-Assess (CTL) within and across the District. The Assessment Department also leads professional development of the data teaming process with the Cobb Collaborative Communities.

The **Personalized Learning Department** is responsible for the Early Intervention Program for struggling learners in elementary schools; the Remedial Education Program in middle and high schools; and the District's Response to Intervention and the Cobb Systems of Support protocols. The Personalized Learning Department supports schools in providing supports and interventions to students. This includes the process of credit recovery, summer learning opportunities, and House Bill 91 diploma petitions. There are many ways in which students can accelerate their mastery of concepts and the Personalized Learning Department leads the efforts to support and accelerate students.

The **Advanced Learning Programs Department** is responsible for advanced learning experiences for all students. This includes gifted identification services and the delivery of gifted service models for students. Additionally, the Department facilitates a talent development process, in order to ensure that high ability learners that have potential to receive gifted services are identified and nurtured. The Department also works to improve the Advanced Placement participation and performance in our high schools and supports accelerated classes, including dual enrollment, and advanced content coursework in middle schools and elementary schools, respectively.

ACADEMIC DIVISION – TEACHING AND LEARNING SUBDIVISION

WORKLOAD INDICATORS

INDICATOR	FY 2020 RESULTS	FY 2021 RESULTS	FY 2022 RESULTS
AVID	<ul style="list-style-type: none"> • 23 Sections offered • 5 AVID sites • 148 Tutor hrs/week • 100% AVID students on track for 4-year university • 2 AVID sites certified (1st year implementing sites are not up for certification) • 1 AVID National Demonstration School 	<ul style="list-style-type: none"> • 25 Sections offered • 6 AVID sites • 117 Tutor hrs/week • 100% AVID students on track for 4-year university • 3 AVID sites certified (1st year implementing sites are not up for certification) • 1 AVID National Demonstration School 	<ul style="list-style-type: none"> • 28 sections offered • 6 AVID sites • 184 tutor hours/week • 100% AVID students on track for 4-year university • 6 AVID sites certified • 1 AVID National Demonstration School
Courses available on-line to students	<p>GradPoint <i>Credit Recovery:</i> 17 High Schools 1 Special Schools 2,927 Seats 2,896 Units earned</p> <p><i>GradPoint as a digital resource:</i> High School Summer School and Cobb Horizon High School 4,476 Seats 3,820 Units</p> <p><i>Course Extension-</i> 15 High Schools utilized GradPoint 2,037 Seats</p> <p><i>Course Refresher-</i> 3,777 total sessions</p>	<p>GradPoint <i>Credit Recovery:</i> 17 High Schools 1 Special Schools 2,641 Seats 2,527 Units earned</p> <p><i>GradPoint as a digital resource:</i> High School Summer School and Cobb Horizon High School 6,013 Seats 5,100 Units</p> <p><i>Course Extension-</i> 13 High Schools utilized GradPoint 4,357 Seats</p> <p><i>Course Refresher-</i> *613 total sessions</p>	<p>**GradPoint/Edmentum <i>Credit Recovery:</i> 17 High Schools 1 Special Schools 3,607 Seats 3,541 Units earned</p> <p><i>**GradPoint/Edmentum as a digital resource:</i> High School Summer School and Cobb Horizon High School 4,510 Seats 3,762 Units</p> <p><i>Course Extension-</i> 13 High Schools utilized GradPoint 3,594 Seats</p> <p><i>Course Refresher-</i> 379 total sessions</p>

* Each unit represents ½ credit.

** During the Spring of the 2021-2022 school year, the District began implementing Edmentum as the digital resource for credit recovery as the vendor for GradPoint will be sunsetting this product. Edmentum will replace GradPoint in all schools beginning with the 2022-2023 school year.

ACADEMIC DIVISION – TEACHING AND LEARNING SUBDIVISION (Continued)

INDICATOR	FY 2020 RESULTS	FY 2021 RESULTS	FY 2022 RESULTS
Standardized Tests Administered	*236,895	*126,512	*144,860
GKIDS	7,839	6,749	7,214
CogAT	24,621	24,782	21,438
Iowa	24,842	24,846	21,641
EOG (3-8)	***0	36,983	46,717
EOG re-test	***0	0	0
ACCESS for ELLs	11,894	10,931	12,558
Alt ACCESS ELLs	144	123	130
GAA	***0	693	744
EOC (Winter)	21,522	9,543	11,836
EOC (Spring)	***492	12,199	22,393
EOC (Summer)	***0	23	189
SGMs (formerly SLOs)	***145,541	***0	***0
Universal Screener:			
• Reading Inventory	***148,199	***177,906	***195,634
• Foundational Reading Assessment	**39,851	**48,702	**50,891
• Math Inventory	**163,246	**187,342	**216,388

* The total Standardized Tests number does not include the Universal Screener numbers (RI and MI) as they are not considered required assessments, but screening for possible intervention.

**MI numbers represent the transition to MI 3.0. During the Fall, only 6 Proof of Concept Schools administered the assessment. All schools (K-9) began administering the MI 3.0 during the Winter 2019 assessment window.

*** Assessments administered in the Spring of 2020 were cancelled due to the COVID-19 shutdowns. This impacted the number of assessments administered over the course of the school year for identified assessments.

**** Student Growth Measures (SGMs) were suspended for the 2020-2021 and 2021-2022 school years. SGMs have been discontinued beginning with the 2022-2023 school year.

Office of Federal Programs

The Office of Federal Programs consists of two priorities that are 1) focused on enhancing the resources and support for students and families and 2) administering federal funds that flow through the Title I and Title III grant.

Title I

Title I is a federally funded program which provides supplemental funding to schools that serve a higher percentage of economically disadvantaged students. Currently, there are 44 Title I identified schools in Cobb County (29 ES, 11 MS, 3 HS, and 1 special program). Cobb County conducts an annual review of district data to determine District and local school needs, as well as prepares a summary of needs that is

ACADEMIC DIVISION – TEACHING AND LEARNING SUBDIVISION (Continued)

submitted to the state. The Title I Department then works with all Title I eligible schools to develop a plan and budget that align to their needs and meets the federal and state compliance requirements. The Title I Office is responsible for ensuring that the expenditures supplement resources provided by the district, as opposed to supplanting the district’s allocation to schools. The federal dollars that flow through Title I must be used for services above and beyond what the district already provides all schools.

The **Homeless Education Program** operates in accordance with the McKinney-Vento Homeless Assistance Act which ensure educational rights for children and youth experiencing homelessness. The primary goal is to identify students experiencing homelessness and to provide educational stability by eliminating barriers and promoting academic success.

Additionally, Title I ensures the equitable allocation of funds and services to children residing in facilities because they are orphaned, are under state custody, and/or residing within Cobb school attendance zones that receive Title I services but instead attend private schools.

WORKLOAD INDICATORS

INDICATOR	FY 2020 RESULTS	FY 2021 RESULTS	FY 2022 RESULTS
Title I Program			
# Schools served	45	44	44
# Students served	39,415	37,213	37,219
As reported in Student Record	44 School-wide Title I Targeted Assistance	43 School-wide Title I Targeted Assistance	43 School-wide Title I Targeted Assistance
Homeless Ed Program			
# Applications processed	3,516	2,411	3,470
# Students qualified & served	1,441	1,117	1,549
# Students kept in school of origin	532	441	649
# Transportation Assistance (school buses, gas cards, taxis, public transit)	459	201	524
# Student Support (free lunch, school supplies, standard school attire)	1,331	1,058	1,469
# Tutoring/Academic Assistance	173	99	200

ACADEMIC DIVISION – TEACHING AND LEARNING SUBDIVISION (Continued)

ESOL/Title III Program

The **ESOL/ Title III Program** mission is developing the English proficiency of English Learners (ELs) while advancing their academic content achievement. The State Funded CCSD ESOL Program offers research-based English language assistance services to ELs and provides opportunities for these students to become productive, contributing members of the Cobb County community and global citizens in a diverse world.

The goal of the ESOL program is for CCSD English Learner students to attain full proficiency within five years, master grade level academic content, reach their full academic potential on par with the native English-speaking peers, and become responsible and productive members of society. To accomplish this goal, the CCSD ESOL program:

- Creates a welcoming learning environment that allows students to take risks as they learn a new language and navigate a new culture
- Explicitly values and actively leverages students’ home language, culture, and prior learning
- Addresses cultural differences affirmatively, building background knowledge needed for students to understand purpose and context
- Provides both academic and social emotional support
- Builds connections between student learning experiences in ESOL and learning experiences in other academic subjects
- Engages the families of English Learners to support the education of their children and become active participants in the school and community
- Fosters appreciation of diverse populations within the school and the community

INDICATOR	FY 2020 RESULTS	FY 2021 RESULTS	FY 2022 RESULTS
ESOL/Title III			
# Students served	11,726	10,556	11,254
IWC/TITLE III			
# Students served	624	172*	722
#Transcripts Analyzed			***319
IWC- Translation/Interpretation			
# Students served	11,953*	5,926**	6,642

Note: Schools closed March 13, 2020 due to the COVID-19 pandemic, limiting interpreted meetings for the remainder of the year.

*The number of students served was impacted due to the COVID-19 pandemic.

**Data capture interrupted when migrating to the new Electronic Language Request system. The new ELR system collects data more accurately and is managed internally by the IWC and Technology Services.

***Data collection on the # of transcripts being sent to the IWC for analysis began in the 21-22 school year.

International Welcome Center (IWC)

The International Welcome Center (IWC) mission is two-fold:

1. To welcome culturally and linguistically diverse (CLD) students enrolling in middle or high school and providing services that set them on a trajectory of success.
2. To facilitate high quality, interactive communication between CLD families and CCSD schools.

The International Welcome Center (IWC) provides the following:

- International student services for new CLD students enrolling in grades 6-12 include screening for proficiency in English and eligibility for ESOL language instructional support, assessing math and native skills, interviewing families, advisement on appropriate services, transcript evaluation, and ongoing support for CLD parents.
- Support for effective communication between the district with CLD families, including interpretive services for student evaluations, parent conferences, special education meetings, and hearings as well as translations of written documents.

Office of Applied Learning & Design

The Office of Applied Learning and Design consists of eight departments including Instrumental Music, General and Choral Music, Theatre, Dance, Learning Design & Visual Arts, Career, Technology & Agriculture Education, STEM & Innovation, Learning Resources, Digital Transformation, and Library Media Education. Current goals include:

- Transforming instructional practices and spaces to allow for innovation
- Offering an extensive portfolio of career pathways through engaging environments and industry-leading programs and partners
- Promoting a digital transformation strategy for moving teaching and learning into a personalized and blended, digital learning environment
- Providing customized digital and print learning resources aligned to the Cobb Teaching and Learning Standards
- Expanding the arts through Arts Integration practices, real-world opportunities, and exposure to cultural events
- Guiding schools through the process of STEM/STEAM implementation and certification

The **Library Media Education (LME)** department provides vision and support for 111 library media programs. Professional learning opportunities are provided throughout the year to support the media specialists' role as instructional partners and teacher leaders. Recognizing the power of flexible spaces, LME also works with schools to transition the media center space to a Library Learning Commons model that accommodates whole classes, small groups, collaborative projects, and digital learning. LME is responsible for providing reliable and current print and digital supplemental resources, such as databases and eBooks, for students to use at school and at home for conducting research and completing projects.

ACADEMIC DIVISION – TEACHING AND LEARNING SUBDIVISION (Continued)

The **Learning Resources** department oversees the content acquisition process for District materials including publisher purchased, open educational and District-produced resources. Also, this department works with the Office of Instruction and Innovative Practice to provide training to schools on available resources and to model implementation of the resources as aligned to best practices. Finally, this department stays apprised of current trends in teaching and learning to ensure that learning resources supported by the District are impacting student learning and supporting District goals.

The **Digital Transformation Team** is tasked with developing a comprehensive District strategy for moving teaching and learning into a digital learning environment. This includes providing platforms that support personalized and blended learning, that allow for 24/7 access by students, staff and parents, and that provide interoperability among systems. Also, this team works in conjunction with the Office of Instruction and Innovative Practice and Instructional Technology to support teachers on technology integration in the context of content initiatives.

The **Career, Technology, & Agricultural Education (CTAE)** program will prepare students to become career and college ready to compete in a global workforce through exploration, experience, and extension.

The CTAE Program will empower students to successfully participate and compete in a dynamic global workplace. To this end, the curriculum focuses on:

- Infusion of rigorous and relevant academic instruction
- Application of essential global emerging technologies
- Early identification of career cluster opportunities
- A combination of career employability and economic/living skills
- Preparation for post-secondary studies and lifelong learning

The **Performing Arts Program** offers a balanced, comprehensive, standards-based arts curriculum as an important part of the education of the whole child. Courses are offered in dance, music, and theater. We believe that study in the arts:

- Provides students with opportunities to propose and solve problems
- Provides a form of expression, skill development and overall enrichment to encourage lifelong learning
- Celebrates the achievement of diverse cultures
- Inspires creativity, helping students develop their own passions, strengths, and personal voices while creating a sense of family and belonging
- Fosters self-esteem, community pride and skills, giving students hope and goals to strive for in their career pathway and life

ACADEMIC DIVISION – TEACHING AND LEARNING SUBDIVISION (Continued)

WORKLOAD INDICATORS

INDICATOR	FY 2020 RESULTS	FY 2021 RESULTS	FY 2022 RESULTS
Performing Arts			
# of students in music, theatre, and dance classes	*76,263	77,499	84,529
% of CCSD population in music, theatre, and dance	67.01%	68.1%	79.7%
# of theatre performances in HS	64	83	97
# of music performances at ES	68	137	156
# of music performances at MS	55	98	107
# of music performances at HS	171 (includes marching band)	149 (includes marching band)	159 (includes marching band)

*Student count affected by the COVID-19 pandemic Shutdown.

ACADEMIC DIVISION – TEACHING AND LEARNING SUBDIVISION (Continued)

INDICATOR	FY 2020 RESULTS	FY 2021 RESULTS	FY 2022 RESULTS
CTAE			
# Students served	55,593	50,580	50,247
CTAE enrollment			
6th – 8th grade	19,758	16,582	18,026
9th – 12th grade	35,835	33,998	32,221
# Career Pathways offered	50	50	60
# CTAE Students who took an End of Pathway Assessment	1,006	588*	3,124*
% Students Passing End of Pathway Assessment	63%*	75%*	72%*
Graduation Rate for CTAE Concentrators (completed three CTAE courses)	97.00%	98.17%	98.25%
# Professional Development activities completed by CTAE Teachers	196	552	468
Total Perkins grant value	\$733,551	\$809,771	\$756,548

*EOPAs not administered in S2 of SY20 due to GADOE waiver related to COVID-19 Pandemic.

ACADEMIC DIVISION – TEACHING AND LEARNING SUBDIVISION (Continued)

INDICATOR	FY 2020 RESULTS	FY 2021 RESULTS	FY 2022 RESULTS
Library Media			
Learning Commons Transition participation	106 schools	111 schools	111 schools
Learning Commons Transition completion	12 schools	12 schools	12 schools
New facilities opening with Learning Commons model	1	2	0
District professional learning activities completed by media specialists	514 (March PL day canceled)	1,742	1,478
Cobb Digital Library usage	1,051,642	703,603	910,174
Books and media materials circulated through library media programs	1,813,073	667,573	1,887,232
Scholastic Summer Reading Challenge minutes logged by CCSD students	1,632,477 (Beanstack)	981,736 (Beanstack)	1,816,235 (Beanstack)
State/national honors recognitions received	3	2	1

ACADEMIC DIVISION – TEACHING & LEARNING, SUPPORT AND SPECIALIZED SERVICES SUBDIVISION

DIVISION RESPONSIBILITIES

The Division of Teaching & Learning, Support and Specialized Services provides support for students in a variety of ways including: special education services, 504 plans, psychological services, school counseling services, and behavior interventions.

The Division of Teaching & Learning Support and Specialized Services has three programs: **Special Education, GNETS - HAVEN Program, and Student Assistance Programs.**

DIVISION ORGANIZATION

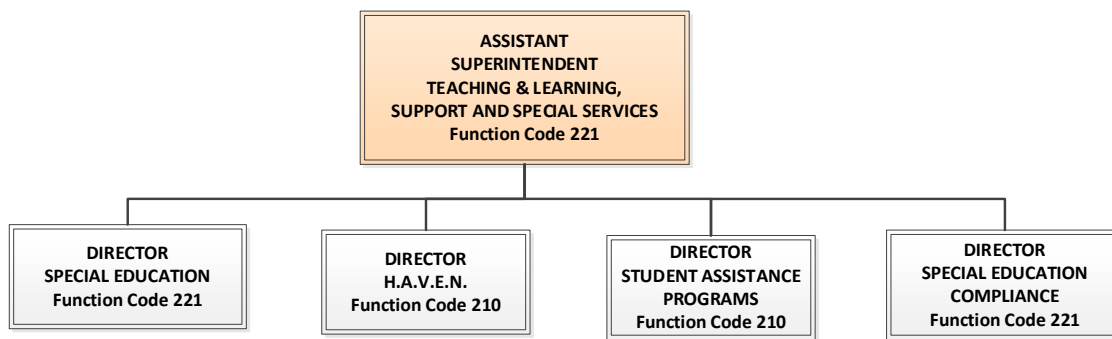

MAJOR DEPARTMENT TASKS

Special Education - The mission of the Cobb County School District Office of Special Education is to provide support to students, parents, and schools to provide opportunities for meaningful outcomes for students with disabilities. CCSD serves students with disabilities in the following categories: autism, deaf/hard of hearing, emotional and behavior disorder, intellectual disabilities, orthopedic impairment, other health impairment, significant developmental delay, significant learning disability, speech language impairment, traumatic brain injury and visual impairment and blindness. The division leadership provides training and support to schools to ensure students receive a free and appropriate education according to IDEA.

Section 504 of the Rehabilitation Act of 1973/Public law 93-112 is a comprehensive law that addresses the rights of handicapped persons (hereafter referred to as persons with disabilities except when quoting the law) and applies to all agencies receiving federal financial assistance. The Division of Teaching & Learning Support and Specialized Services is charged with ensuring that Section 504 eligible students are provided an appropriate 504 plan, if required, and that the plan is implemented as written.

Audiological Services provides complete diagnostic hearing evaluations for any child from birth through high school who resides in the Cobb County School District. Evaluations are provided by licensed

ACADEMIC DIVISION – TEACHING & LEARNING, SUPPORT AND SPECIALIZED SERVICES SUBDIVISION (Continued)

audiologists who test children with multiple disabilities, those who are difficult to test, and children who are at increased risk for permanent hearing loss.

[Vision and Hearing Screening Programs](#) provide services to detect those students who may have a vision or hearing disorder and refer them for further care.

Special Education Compliance - Cobb County School District Office of Special Education Compliance works with schools and families to ensure legal compliance with IDEA and compliance with the Georgia Department of Education for state indicators. This office provides parent mentor support, access to special education records and alignment of compliance procedures across the district. Additionally, this office handles formal complaints through Georgia Department of Education or Office of Civil Rights along with special education legal matters pursuant to IDEA and Section 504.

H.A.V.E.N. Program provides comprehensive special education and support for students with Severe Emotional Behavior Disorders and Autism. The program serves students from Cobb County, Douglas County and the City of Marietta.

H.A.V.E.N. Academy is part of the Georgia Network of Educational and Therapeutic Support (GNETS), comprised of 24 programs statewide that support students with special needs from every school system in Georgia.

H.A.V.E. N. Program improvement goals are:

- Successful reintegration to a least restrictive environment
- Implement research based programs with integrity
- Improve student achievement in reading and math

Student Assistance Programs has the following areas of responsibility:

Psychological Services: The mission is to provide psychological services within the school community through consultation, collaboration, research-based interventions, and individualized assessment in order to facilitate learning and promote positive mental health for students.

School psychologists help students succeed academically, socially, behaviorally, and emotionally. They collaborate with educators, parents, and other professionals to create safe, healthy, and supportive learning environments that strengthen connections between home, school, and the community for all students. Its services include:

- Working to increase student achievement by assessing barriers to learning and helping determine the best instructional strategies to improve learning
- Working with parents and school teams to enhance home-school collaboration
- Working within a multidisciplinary team to evaluate eligibility for special education services
- Facilitating parent, teacher, and student understanding of a variety of disabilities and the impact on school, family, and community functioning
- Assisting teachers in identifying appropriate intervention procedures and evaluating intervention outcomes
- Assisting schools with promoting emotional well-being of students

ACADEMIC DIVISION – TEACHING & LEARNING, SUPPORT AND SPECIALIZED SERVICES SUBDIVISION (Continued)

School Counseling: The mission of the Cobb County School Counseling program is to assist students in overcoming barriers that impede learning. The goal of all Cobb County Professional School Counselors is to implement a standards-based comprehensive school counseling program that:

- Provides specialized interventions based on identified student needs
- Assists students in acquiring appropriate attitudes, knowledge, and communication skills to promote healthy relationships
- Enhances the ability of students to identify and utilize the appropriate resources needed for post-secondary success
- Creates positive relationships with students fostering personal growth, service to others, and academic achievement
- Advocates for all students encouraging them to develop to their fullest potential
- Encourages counselors to consult and collaborate with other educators, parents, and community on behalf of all students

Positive School Culture Support: Provides assistance to CCSD schools in assessing and addressing school climate and culture. By conducting on-site school visits, analyzing multiple sources of data, and meeting with building leadership teams and school staff, they suggest appropriate research-based methods to create effective school-wide, classroom, targeted group, and individual systems to provide a positive learning environment for all students. Staff members provide assistance to schools implementing Positive Behavioral Interventions and Supports (PBIS), providing coaching support, professional learning, and evaluation of implementation fidelity. They provide training and support in Trauma-Informed Schools, Sources of Strength, Wellness, Restorative Practices, and other customized trainings based on school needs.

GRIP: Gaining Results in Intervention and Prevention, an intervention program for students facing suspension for alcohol and other drug policy violation.

Crisis Response: Provides Crisis Response to schools after a death or emergency and provides training to local school crisis teams.

Hospital/Homebound Services: Provides instructional services to students who are able to participate in educational instruction but who are medically unable to attend school for a minimum of ten consecutive days or equivalent on a modified calendar, or intermittent periods of time throughout the school year.

Suicide Prevention and Intervention: Training and support in Signs of Suicide and Sources of Strength is provided by district teams as well as training for district personnel in the ASIST model (Applied Suicide Intervention Skills Training) and Youth Mental Health First Aid.

ACADEMIC DIVISION – TEACHING & LEARNING, SUPPORT AND SPECIALIZED SERVICES SUBDIVISION (Continued)

WORKLOAD INDICATORS

INDICATOR	FY 2020 RESULTS	FY 2021 RESULTS	FY 2022 RESULTS
Total number of students with disabilities	15,621	14,757	14,730
Students with Disabilities' Graduation Rate	79.00%	78.00%	Available in October
Discipline reviews for students with disabilities	318	48	539
Use of alternative dispute resolution strategies			
Mediations	6	13	24
Resolution Meetings	7	6	9
Due Process Hearings	1	0	*0
GRIP Program (students served)	101	21	184
Number of schools supported with services promoting a positive school culture:			
Second Step	12	28	29
Sources of Strength	14	23	23
PBIS	42	41	41
Signs of suicide	-	-	26
Trauma-informed Schools	-	-	10
Staff wellness presentations	-	-	56
Elementary suicide prevention lessons	-	-	66
BRIDGE Law and Naviance	-	-	45
Jason Flatt Law	-	-	112
Psychological evaluations	1,551	1,744	2,593
Hospital/Homebound students served	181	167	279

* Pending 2nd or 3rd FY2022 hearings that will be held in FY2023.

SCHOOL LEADERSHIP DIVISION

DIVISION RESPONSIBILITIES

The Primary function of the **School Leadership Division** is to lead the ongoing development and continuous improvement of an effective instructional program in Cobb County. The division is responsible for all facets of student performance, school leadership, leadership development, curriculum and instruction, special student services, student support, transportation, professional learning, athletics, and human resources.

DIVISION ORGANIZATION

The School Leadership Division is sub-divided into functional areas of responsibility. The CCSD School Leadership Division consists of seven Assistant Superintendents who oversee specific area and level schools within the system: three over elementary schools; two over middle schools; and two over high schools. The following chart illustrates the structure of this division:

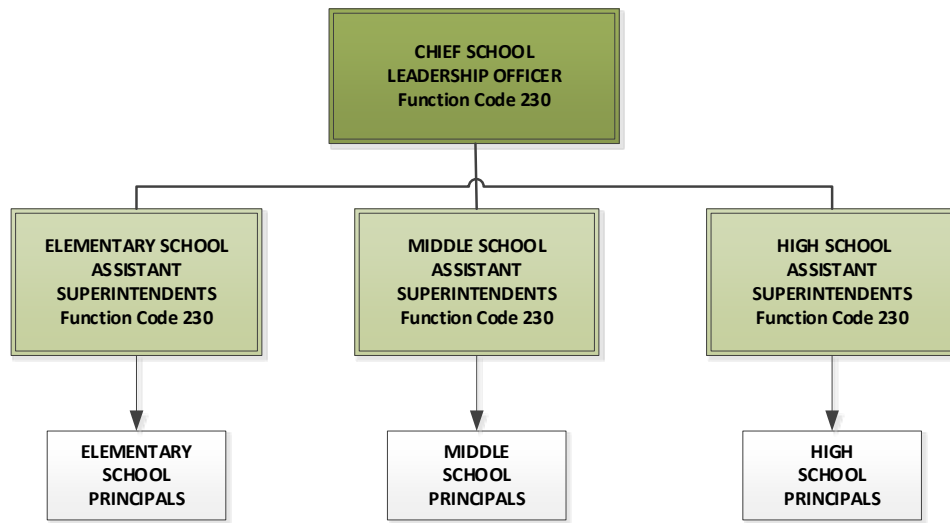

MAJOR DEPARTMENT TASKS

Assistant Superintendents – Elementary Schools, Middle Schools, High Schools assume primary operational, managerial, administrative, leadership development, and oversight responsibility for the elementary, middle, and high schools of assigned K-12 clusters within the framework of the School Leadership Division. The Assistant Superintendents lead principals in expeditious and sound decision making regarding the productivity, results, accountability, staffing, and continuous improvement for individual schools, both from the standpoint of learning effectiveness and operations.

Leadership Development is designed to support a purposeful, systemic district plan for maintaining a highly effective pipeline of leadership succession. Leadership Development within the Cobb County School District represents the collaborative efforts of Human Resources, School Leadership and other contributing departments. The cornerstones are the Academy model, impacting the development of aspiring leaders since 1998, and the Induction model, supporting leaders during their first year in a new position.

SCHOOL LEADERSHIP DIVISION (Continued)

WORKLOAD INDICATORS

INDICATOR	FY 2020 RESULTS	FY 2021 RESULTS	FY 2022 RESULTS
<p><u>School Operations</u> Oversees the operations and leadership of all schools.</p>	Ongoing daily basis.	Ongoing daily basis.	Ongoing daily basis.
<p><u>Assistant Superintendent Meetings</u> Sets the agenda for weekly meetings based on operational, managerial, administrative, leadership development and oversight responsibility.</p>	Met once a week, schedules permitting.	Met once a week, schedules permitting.	Met once a week, schedules permitting.
<p><u>Academic Leadership Meetings</u> Coordinates collaborative meetings that include members from School Leadership and the Academic Divisions.</p>	Met once a month, schedules permitting.	Met once a month, schedules permitting.	Met once a month, schedules permitting.
<p><u>District Leadership and Learning Meetings</u> Assists with planning the agenda for the leadership of the District.</p>	Met 5 times throughout the year.	Met 5 times throughout the year.	Met 5 times throughout the year.
<p><u>Level Principal Meetings</u> Level meetings with the principals are conducted by the seven Assistant Superintendents 5-7 times per year.</p>	Met 6 times throughout the year.	Met 6 times throughout the year.	Met 6 times throughout the year.
<p><u>Assistant Principal Meetings</u> Assistant Principals meet 3-5 times a year with the Chief School Leadership Officer and the Level Assistant Superintendents.</p>	Met 3 times throughout the year.	Met 3 times throughout the year.	Met 5 times throughout the year.

DIVISION RESPONSIBILITIES

The Mission of the Financial Services Division is to handle the financial resources of the Cobb County School District professionally, ethically and legally; and respond to our customers in a courteous, helpful, and timely manner. The values the Division holds are hard work, dedication, and consistency.

Under the direction of the Chief Financial Officer, the Division is responsible for all the fiscal responsibilities of the School District. Specifically, the responsibility areas include: general accounting, food service accounting, local school accounting, financial reporting, cash management, payroll, budgeting, financial planning and analysis, internal compliance, property control, bond/sales tax project management and financial training programming.

The Division manages all the financial operations for the District with a budget in excess of \$1 Billion and over 15,000 employees. It serves the needs of schools, other departments, the Superintendent, Board of Education, and the general public. It operates under established management principles and adheres to established policies and procedures and to generally accepted accounting principles (GAAP).

DIVISION ORGANIZATION

The Financial Services Division is sub-divided into functional areas of responsibility in similar fashion to how most corporations are organized. The following chart illustrates the structure of this division:

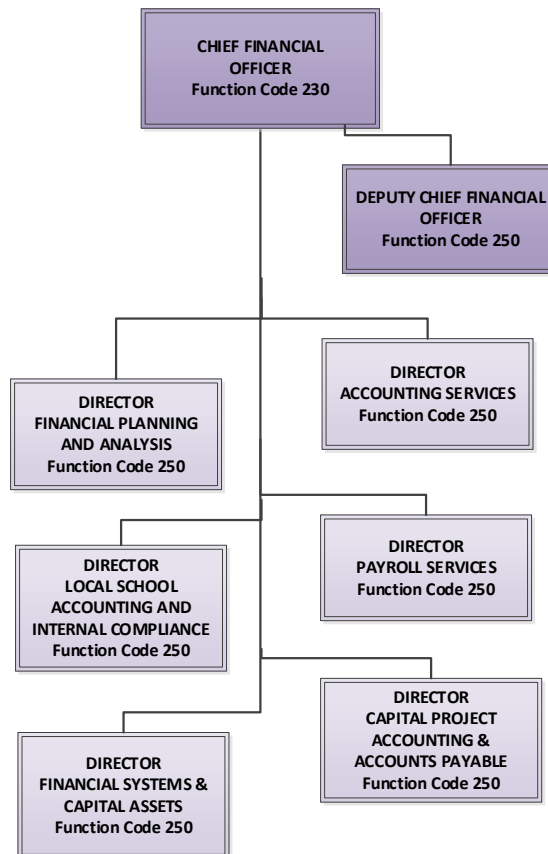

MAJOR DEPARTMENT TASKS

Accounting

1. Invest and manage cash for all central office bank accounts.
2. Manage accounting for all federal, state, and local grants.
3. Manage billing, collection, and accounting for District's account receivables.
4. Review and process all District journal vouchers and monitor all General Ledger entries.
5. Prepare Board Monthly and Quarterly Financial Reports, Annual GA DOE Financial Reports, Annual Transparency in Government Act Reports, and Annual Comprehensive Financial Report.
6. Deposit all central office incoming cash receipts on a daily basis.
7. Reconcile 126 depository bank accounts on a monthly basis.
8. Manage procurement card purchases to ensure compliance with District policy and to accurately record purchases in accounting system.
9. Produce and provide updates for the "[Procurement Card Manual](#)."
10. Provide accounting services for the Cobb County Public Schools Foundation.
11. Coordinate and provide data for annual external financial audit.
12. File Unclaimed Property Checks and Reports to state and reissue checks to payees.

Cash Management

1. Obtain maximum interest on available funds while ensuring safety of investments.
2. Assist schools with all banking services.

Food Service Accounting

1. Review daily deposits of 108 lunchrooms. Reconcile bank deposits to Food and Nutrition Services (FNS) data.
2. Research, reconcile, and journal all bank adjustments to daily lunchroom deposits (Bank Debit and Credit Memos).
3. Journal NSF returned checks and initiate collection efforts. Monitor outstanding uncollected receivables.
4. Process and reconcile weekly meal data from FNS to ensure the accuracy of the monthly federal claim for reimbursable meals.
5. Prepare monthly financial statements in accordance with generally accepted accounting principles and submit to Georgia Department of Education.
6. Provide accounting and advisory support services to FNS management and staff on an ongoing basis.

Financial Planning & Analysis/ Budgeting

1. Develop a budget in excess of \$1 Billion each year (all funds).
2. Prepare and present various financial/budget reports and presentations.
3. Create the account codes in newly implemented MUNIS financial system, and monitoring its use, in compliance with the State Chart of Accounts for financial reporting.
4. Coordinate the preparation, review, and approval of budget transfer and amendment process.
5. Review all purchase orders from schools and department of central office to ensure adequate account codes, budget amounts, and correct procedures.
6. Prepare the credit rating agency report and coordinate the presentation to the agencies by the CFO.
7. Prepare and coordinate the advertisement and presentation of the local property tax digest and millage rate for adoption by the Board.

Payroll

1. Annually process over 235,000 payroll remittances for approximately 18,000 employees.
2. Process and account for all payroll deductions.
3. Account for all employees leave.
4. Annually process employee W-2 forms.
5. Process all employee travel reimbursement.

Accounts Payable

1. Pay all District expenditures.
2. File federally required IRS 1099 documents on all appropriate vendors.

Capital Projects

1. Oversee the remaining expenditures for the SPLOST 4 and current SPLOST 5 spending that approved in March 2017 with another five years budget of \$797 million.
2. Set up accounts, process budget adjustments, encumber service contracts and process payment transactions for all capital outlay funds.
3. Prepare and distribute printed reports and intranet reports to Board members, budget administrators, and citizens.
4. Prepare and submit CAFR schedules and year-end financial reports.
5. Work with project managers and District personnel on new schools, additions/renovations and curriculum and technology projects.
6. Request reimbursement for State funded capital outlay projects and monitor revenues.

Local School Accounting & Internal Compliance

1. Updates the following local school manuals:
 - Local School Accounting Standard Operating Procedures
 - Local School Accounting Chart of Accounts
 - ASP Standard Operating Procedures
2. Reconciles and analyzes 110 school bank accounts each month.
3. Issues monthly financial management reports to Principals at each school.
4. Trains new Bookkeepers on local school accounting operations and procedures.
5. Provides ongoing local school accounting financial training/customer service support to all schools in the District.
6. Provides training and ongoing support to schools regarding the Online Credit Card Program for student activities and fees.
7. Provides financial training regarding local school activity funds for all new Principals and aspiring Principals.
8. Prepares annual local school accounting closing entries for upload to State.
9. Provides Local School Accounting software and hardware support and maintenance primary school safes and wall safes (black boxes) at schools.
10. Issues control documents to schools and maintains proper number of documents in department inventory.
11. Acts as liaison between the School District, the armored car service, and the District bank.
12. Participates in interviews for Bookkeeper openings at all local schools.
13. Manages a staff of Temporary Support Bookkeepers and assigns schools temporary bookkeeping support as needed.
14. Reviews District Staff Coordination Records.
15. Manages the financial operations of the After School Program
16. Monitors and reports on the budgets and financial status of 62 After School Programs.
17. Approves all requisitions using ASP funds.
18. Coordinates the completion of local school audits with external audit firm.
19. Monitors daily purchase card activity.

20. Conducts periodic reviews of purchase card transactions in Munis.
21. Monitors vendor transactions in Local School Accounting.
22. Assists schools with reporting unclaimed property per state requirements.
23. Supports all financial and operational activities of the school district. The Department is an independent, objective assurance and consulting function established to add value and improve operations.
24. Performs compliance reviews of schools, departments, and school support organizations to determine compliance with applicable state, local, and district policies and procedures.
25. Participates in the RFP process as needed for contracts related to Local School Accounting & Internal Compliance.

Financial Systems

1. Implements software solutions designed to increase operational efficiencies while providing enhanced end user functionality.
2. Manages financial and technology projects related to District initiatives.
3. Coordinates Munis system upgrades and module enhancement/implementations by creating test scripts, monitoring testing progress, assisting in user acceptance validation, and reporting/documenting testing issues.
4. Conducts financial analysis and reporting used by District personnel to make decisions and/or reconcile data.
5. Develops and delivers application training for implemented software solutions to District personnel while ensuring compliance with state, federal, and District policies and procedures.
6. Plan, design, document, maintain, and deliver training using one-on-one, classroom, online, or blended methodologies to support Principals, Bookkeepers, Payroll Timekeepers, Maintenance Technicians, and Central Office personnel on software and operational procedures.
7. Maintains content on Cobb County School District's SharePoint Intranet sites of the Munis Library, ASP Training, Principal Training, Bookkeeper Training, Backup Bookkeeper Training, Payroll Timekeyer Training, the Financial Services One Team Intranet pages which include Financial Services form bank, Cobb Schools Finance University, and other web-based resources that contains up-to-date news, forms, policies, procedures, and training courses related to the Financial Services of the District.
8. Assists the Financial Services Directors on the development and delivery of training curriculum.
9. Provides ongoing technical support to system end users to troubleshoot system issues, test and validate system issues and configuration and create/manage technical support tickets with software vendors.
10. Recipient of the 2014 Association of School Business Officials International (ASBO) Pinnacle Award for the Financial Services University.
11. Recipient of the 2020 Tyler Technologies National Public Sector Excellence Award for our Munis System Implementation.

Capital Assets

1. Manages the District's Assets including Equipment, Building, Land and Construction in Progress.
2. Processes and posts all Capital Building, Land and Construction in Progress Asset transactions.
3. Conducts monthly reconciliation of the District asset transactions against the financial transactions to ensure assets are appropriately classified for reporting and depreciation.
4. Manages the monthly and annual capital asset depreciation and reconciliation process to ensure all transactions balance to the general ledger and all variances are appropriately documented for auditing purposes.
5. Processes and manages donated assets in accordance with board policy FEAE-R Construction on District Property Funded by Others.
6. Collaborates with Capital Projects to ensure accurate processing of the District's capital assets, including construction projects, architectural fees, and land acquisitions.

7. Annually reviews Construction in Progress asset values to ensure compliance with capitalization threshold and reclassifies assets as necessary.
8. Assists in the preparation of the annual financial audit and related work papers for the year-end closing process.
9. Tags, adds, and identifies all equipment subject to inventory.
10. Prepares property reports for special projects. (Examples: Technology Refresh of SPLOST Purchased Equipment, State Technology Survey).
11. Maintains reports for all equipment subject to inventory.
12. Conducts physical inventories and provides resulting reports for all local schools, special schools, and central office locations.
13. Composes, interprets and updates the District's Property Control Users Guide and Munis Capital Assets Procedural Documentation.
14. Transfers excess equipment to the warehouse for surplus utilizing the eqTransfer system.
15. Disposes of surplus equipment approved by the Board.
16. Prepares property reports for schools and departments as requested.



WORKLOAD INDICATORS

INDICATOR	FY 2020 RESULTS	FY 2021 RESULTS	FY 2022 RESULTS
Accounting			
Average Yield on Investments			
90 Day T-bill (April through June)	.14%	.03%	1.08%
School District	.31%	.05%	.93%
Number of Central Office deposits (excludes lunchroom depository account)	1,711	1,705	2,219
Total bank transactions	48,455	48,307	55,491
Total number of Journal Vouchers processed	1,708	933	937
Total number of Procurement card transactions	78,979	63,637	92,632
Total dollar volume	\$27,921,693	\$17,679,922	\$21,333,036
Annual Comprehensive Financial Report Published	Yes	Yes	Yes
Grant dollars collected: Federal, State, & Local Grants Administered	\$60,577,670	\$180,215,853	\$137,260,283
Financial Planning & Analysis			
Budget Document published	Received ASBO Meritorious Budget Award	Received ASBO Meritorious Budget Award	Received ASBO Meritorious Budget Award
Credit Rating **			
- Moody's Investor Services	Aaa	Aaa	Aaa
- Standard & Poor's	AAA	AAA	AAA
- Kroll Bond Rating Agency	--	--	AAA
Payroll			
Payroll Check Runs Processed	38	38	38
Payroll Remittances Issued	240,000	235,000	235,000
Dollar value of payrolls processed	\$812,363,528	\$823,131,377	\$899,324,242
W-2 Forms Issued	18,353	18,353	17,933
Accounts Payable			
Accounts Payable Check Runs Processed	158	76	97
Accounts Payable Checks Issued	14,357	12,407	12,960
Dollar value of checks processed	\$295,364,461	\$274,843,059	\$275,849,095
LSA & Internal Compliance			
Bank Reconciliations	1,320	1,320	1,320
Bookkeeper Interviews	36	52	37
Bookkeeper Training Hours	--	420	585
LSA Customer Support Hours	3,470	3,570	3,570
LSA Temporary Support Hours	--	3,600	6,000

** Moody's Aaa credit Rating awarded to CCSD since 2015. Standard & Poor's designated AAA in 2020. The Kroll Bond Rating Agency granted CCSD the AAA rating in December 2021.

INDICATOR	FY 2020 RESULTS	FY 2021 RESULTS	FY 2022 RESULTS
LSA & Internal Compliance			
Elementary School Audits	53	67	67
Middle School Audits	21	25	25
High School Audits	14	17	18
Special School Audits	N/A	N/A	N/A
Operational Audits/Projects	2	0	0
Vendor Transaction Reviews	110	0	0
Monitoring of Procurement Card Transactions	3,961	476	720
After School Program Customer Support Hours	--	1,904	1,904
Consulting/Advisory Services for District	2	0	0
Note: External audit firm hired to perform school audits beginning in fiscal year 2014. RFP for performance of school audits for additional 5 years through 2022.			
Financial Systems			
Financial Services Web Maintenance SharePoint, Cobb Schools Finance University, Form Bank, Intranet & other Web Resources	800	683	779
Financial Analysis & Reporting Hours	638	107	428
Financial Grant/Title I Training/Prep Hours	121	20	0
Other Projects	388	686	658
Software Implementation/Upgrade Testing	2,809	2,150	2,515
Software/Technical Support	1,075	2,227	4,276
Training & Preparation Hours	4,000	2,942	1,804
Training Video Production Hours	90	20	140
Number of Munis End Users Supported	969	1,681	1,665
Number of Eleyo End Users Supported	--	--	225
Munis Modules Supported	12	21	21
Munis Mobile Applications Supported	2	2	3
Integrated Systems Managed	--	--	8
Annual SharePoint Site Visits			
Backup Bookkeeper	--	2,908	1,250
Bookkeeper Training	--	78,524	58,703
Cobb Schools Finance University	--	14,180	12,447
Eleyo Library	--	--	33,062
Munis Library	--	32,784	30,527
Payroll Timekeyers	--	1,740	1,934
Principal Training	--	6,716	3,179
Capital Assets			
Property Inventories Completed	21	22	32
Inventory Items Added	14,705	47,865	55,898
Inventory Surplus	18,480	10,705	10,820
Active Equipment Assets Managed	134,007	176,437	218,844
Number of Land Purchases/Sold	2	1	0
Construction in Progress Assets			
Converted/Capitalized	14	16	13
Converted/Non-Capitalized	31	27	0

KEY PRINCIPLES GUIDE BUDGET DEVELOPMENT
(Policy Index DB Topic Highlight)

BUDGET DEVELOPMENT:

1. General Provisions:

a. Revenue:

Each General Fund revenue account shall be analyzed during the budget development process to develop reasonable budget assumptions, projections and detailed documentation for each revenue account category.

b. Expenditure Appropriations:

- (1) Position counts will be calculated by Division and classification based on Local School Allocation Formulas and a continuation of prior year positions in school support departments.
- (2) Proposals for incremental budget appropriation increases or decreases shall be presented to the Superintendent annually for consideration in the budget development process.

c. General Budget Development Methodology:

- (1) The budget will be developed utilizing a structural balanced budget philosophy where recurring revenue equals recurring expenditure appropriations. If one time funds are used from fund balance to assist in balancing the General Fund budget, the expenditure appropriations associated with those one time funds shall be identified as part of the budget approval process and the Board will identify recurring funds for these expenditure appropriations in the immediate subsequent budget

development year. The Board shall maintain the objective to keep the General Fund reserve at a level of at least 8.33% (One Month Reserve) of General Fund Expenditure Appropriations.

- (2) The budget will be developed utilizing a Budget Calendar where each budget event is identified along with a person responsible for completion of that event.
- (3) All budget development budget calculations shall be presented along with assumptions utilized in projecting budget estimates.

2. Budget Development Process:

a. The District will utilize an annual budgeting process that includes:

- (1) A credible projection of revenues and expenses;
- (2) Separation of capital and operational items;
- (3) Cash flow;
- (4) Disclosure of planning assumptions upon which District leadership based its planning;
- (5) Total projected obligation and cost of new and proposed multi-year programs; and
- (6) Annual and remaining obligation and cost of existing multi-year programs.

b. As part of the budget adoption process, the Superintendent will present to the Board of Education and make public those budget items pre-approved by the Board from specific approval in the spending authority of the Superintendent. (see Board Policy DI ([Accounting and Reporting]).

KEY PRINCIPLES GUIDE BUDGET DEVELOPMENT (Continued)
(Policy Index DB Topic Highlight)

- c. The District shall not create long-term obligations of employment, compensation, or benefits for employees, consultants, contract workers or volunteers, that extend beyond reliable revenue projections.
- d. The District shall not treat Board approved budget adjustments during the fiscal year as carry-overs to be included in the initial budget amount for the subsequent fiscal year. Rather, the subsequent fiscal year budget process shall:
 - (1) Identify both the original amount included in the current year budget and the amount of any adjustment approved by the Board during the current fiscal year; and
 - (2) Identify adjustments needed for recurring expenses as budget enhancements in the subsequent fiscal year budget process.
- e. **General Fund Budget Development Events:**
 - (1) Administration will develop an annual Budget Forecast for Revenues and Expenditure Appropriations.
 - (2) Administration will develop a Budget Calendar.
 - (3) Administration will seek budget input from the Board of Education.
 - (4) Administration will prepare a tentative, balanced budget for consideration by the Board of Education prior to the Board's review of the budget.
 - (5) The Board will conduct budget meetings as necessary to review and finalize the tentative, balanced budget.
 - (6) The Board will approve the Budget before June 30 each year.
- f. **Continuing Budget Management:**
 - (1) All General Fund, fund balanced budget adjustments must be

approved by the Board during the fiscal year of July 1 through June 30.

- (2) Administration shall provide financial and budget information as requested by the Board during the fiscal year.

3. Public Notice:

a. **Advertisement:**

The Board shall advertise at least one time in a newspaper of general circulation in Cobb County the proposed budget for each fiscal year. The advertisement shall be made prior to the meeting of the Board of Education at which the District budget for the fiscal year is to be finally adopted and shall follow the form required by the State Board of Education.

b. **Hearings:**

Before the budget is officially adopted, the Board shall hold a public hearing to explain the proposed budget and invite questions and discussion from the administration and public relative to the budget.

4. Millage Rate:

- a. The Board shall annually recommend to the County Commissioners the tax millage for the county to be collected for school purposes only and in compliance with Article 8, Section 6, Paragraph I(a), of the Georgia Constitution which provides that the millage rate shall not be greater than 20 mills.
- b. The Board shall approve the General Fund millage rate annually by July 1 and shall conduct millage rate hearings as required by State of Georgia law.

DISTRICT POLICY ON FUND BALANCE AND RESERVE
(Policy Index DI Topic Highlight)

FUND BALANCE:

1. In accordance with Governmental Accounting Standards Board (GASB) Statement 54,

the Board recognizes the following five categories of fund balances for financial reporting purposes:

- a. *Non-spendable Fund Balance* – non-cash assets such as inventories or prepaid items.
- b. *Restricted Fund Balance* – funds legally restricted for specific purposes, such as grant funds.
- c. *Committed Fund Balance* – amounts that can only be used for specific purposes pursuant to a formal vote of the Board. The Board, as the government’s highest level of decision-making authority, may authorize expenditures from the committed fund balance by a formal vote prior to the District’s fiscal year-end for that fiscal year. Future modification or rescission of committed funds must likewise be accomplished by a formal vote of the Board prior to fiscal year-end. A majority Board vote is required to approve a commitment and a majority Board vote is required to remove a commitment.
- d. *Assigned Fund Balance* – amounts intended by the Board for specific purposes. The Board expressly delegates to the Superintendent, through the Chief Financial Officer, the authority under this policy to assign funds for particular purposes. Such assignments cannot exceed the available fund balance in any particular fund.
- e. *Unassigned Fund Balance* – residual spendable fund balance after subtracting all above amounts.

2. Spending Prioritizations:

- a. When an expenditure is incurred that would qualify for payment with either restricted or unrestricted funds, it will be paid from restricted funds.
- b. When an expenditure is incurred that qualifies for payment from either of the three unrestricted fund balance categories, it will be applied in the following order:
 - (1) Committed,
 - (2) Assigned, and
 - (3) Unassigned.

3. Minimum Unassigned Fund Balance:

The District will strive to maintain a minimum Unassigned Fund Balance in its General Fund of at least 8.33% of budgeted expenditures. This minimum fund balance is to protect against cash flow shortfalls related to timing of projected revenue receipts and to maintain an emergency funding source.

4. Replenishing Unassigned Fund Balance Deficiencies:

When the Unassigned Fund Balance falls below the minimum of 8.33%, the District will replenish shortages/deficiencies using the following budget strategies and timeframe:

- a. The following budgetary strategies shall be utilized by the District to replenish fund deficiencies:
 - (1) The District will reduce recurring expenditures to eliminate any structural deficit;
 - (2) The District will increase recurring or one-time revenues or pursue other funding sources; or
 - (3) Some combination of the two options listed above.

DISTRICT POLICY ON FUND BALANCE AND RESERVE (Continued)
(Policy Index DI Topic Highlight)

- b. Minimum Unassigned Fund Balance deficiencies shall be replenished within the following time period:
 (1) Deficiency resulting in a minimum Unassigned Fund Balance of less than 8.33% shall be replenished over a period not to exceed two (2) years.

5. Total Fund Balance:

Should the Total Fund Balance of the General Fund ever exceed 15% of budgeted expenditures, the District will:

- a. Utilize excess funds for one-time expenditures that are non-recurring in nature and which will not require additional future expense outlays for maintenance, additional staffing or other recurring expenditures; or
- b. Consider transferring excess funds to a separate Capital Accumulation Fund (Committed Fund Balance).

6. Pursuant to the provisions of GASB

Statement 54, the Board hereby commits substantially all of the revenue received by the following Special Revenue funds to be used exclusively for each respective program's operating expenditures.

<u>Special Revenue</u>	<u>Committed Revenue Source</u>
Donations	Donations by individuals or organizations to benefit school program
After School Program	Attendance and registration fees of After School Program (ASP)
Performing Arts	Voluntary student contributions to fund Performing Arts program
Tuition School	User tuition charges
Facility Use	User rental fees
Adult High School	User tuition/GED fees
Public Safety	Student Parking Permit Fees
Artists at School	Donations to fund artist workshops at local schools
Local Schools	Funds earned or donated at local schools are to be used by local principals to benefit students and faculty subject to District policy.

FUND DESCRIPTION AND BASIS OF ACCOUNTING

The District uses funds to report on its financial position and the results of its operations. Fund accounting is designed to demonstrate legal compliance and to aid financial management by segregating transactions related to certain governmental functions or activities. A fund is a separate accounting entity with a self-balancing set of accounts.

An important principle that the Governmental Accounting Standards Board (GASB) *Codification of Governmental Accounting and Financial Reporting Standards* includes within the code is the “[Basis of Accounting](#)” which refers to when revenues, expenditures, expenses and transfers, and the related assets and liabilities are recognized in the accounts and reported in the financial statements.

When budgeting for revenue and expenditures, the District uses one of two methods that the GASB approved: accrual basis or modified accrual basis. [The accrual basis](#) of accounting recognizes transactions in the accounting period when they occur and the revenue becomes objectively measurable and earned. Under the [modified accrual basis of accounting](#), expenditures are recognized when they are measurable and incurred; and the revenues must meet two criteria: measurable and available. Available means that the revenue was collected during the year or will be collected within a specified period of time after year-end. The District considers revenues available if they are collected within 60 days after year-end. Budgets are adopted on a basis other than accounting principles generally accepted in the United States of America (GAAP) as allowed by the State of Georgia.

The basis of budgeting is the same as the basis of accounting used in the District’s Annual Comprehensive Financial Report (ACFR) for both Governmental funds and Proprietary funds.

Governmental funds are those through which most governmental functions of the District are financed. Governmental fund types use the flow of current financial resources measurement focus and the [modified accrual basis of accounting](#). Under the modified accrual basis of accounting, revenues are recognized when measurable and available. “Measurable” means the amount of the transaction can be determined; and “available” means collectible within the current period or soon enough thereafter to pay liabilities of the current period. The District considers revenues available if they are collected within 60 days after year-end. Property taxes, sales taxes, and interest are considered to be susceptible to accrual. Revenue from grants and donations is recognized in the fiscal year in which all eligibility requirements have been satisfied.

Expenditures are generally recognized when the related fund liability is incurred, except for the principal and interest on general long-term debt, claims and judgments, and compensated absences, which are recognized as expenditures to the extent they have matured.

The District appropriates budgets for governmental funds including the following fund types:

The ***general fund*** is the District’s primary operating fund. It accounts for all financial resources of the general government, except those required to be accounted for in another fund. Major revenue sources include state funding under the Quality Basic Education Act (QBE) and local property taxes. Expenditures include all costs associated with the daily operations of the schools, except for federal and state grant funded programs, school construction, debt service, lunchroom operations, and interdepartmental services.

FUND DESCRIPTION AND BASIS OF ACCOUNTING (Continued)

The *special revenue funds* are used to account for the proceeds of specific revenue sources that are legally restricted to expenditures for specified purposes. The District has three categories of special revenue funds depending on the revenue source and program purpose.

1. Funds which are funded primarily through fees and tuitions to provide extracurricular activities and special services to the students and citizens of the District.
2. Funds which are funded with State revenues to provide programs and services specified by the State of Georgia.
3. Funds which are funded with Federal revenues to provide programs and services specified by the Federal government.

The *debt service fund* accounts for the accumulation of resources for, and the payment of, general long-term debt principal, interest, and related costs. The primary revenue source is local property taxes levied specifically for debt service.

The *capital project funds* account for financial resources used for the acquisition and construction of major capital facilities. The District has four funds used for that purpose: District Building Fund, Systemwide County-Wide Fund, SPLOST IV (Special Purpose Local Option Sales Tax IV), and SPLOST V Fund.

Proprietary funds are those used to account for ongoing organizations and activities which are similar to those found in the private sector. The District appropriates budgets for proprietary funds which are accounted for on the flow of economic resources measurement focus and use the [accrual basis of accounting](#). Under this method, revenues are recorded when earned and expenses are recorded at the time liabilities are incurred, regardless of when the related cash flow takes place. Proprietary funds include the following fund type:

Internal service funds are used to account for the financing of goods or services provided by one department to other departments on a cost-reimbursement basis. The District has two individual funds in the Internal Service Funds category, which are the Unemployment Fund and the Self-Insurance Funds. These funds are used to account for the District's self-insurance programs.

Agency funds are the fiduciary funds that report only assets and liabilities, are custodial in nature, and do not present results of operations or have a measurement focus. It focuses on net assets and changes in net assets. The District has two individual Agency funds: the Club and Class Fund and the Payroll Withholding Fund. The funds are used to account for assets held by the District as an agent for special school groups and clubs and for salary withholdings collection agencies. The District does not appropriate budgets for these funds.



OTHER SUSTAINING LOCAL REVENUE SOURCES

In addition to local property tax revenue, state QBE revenue, and federal revenue, the Cobb County School District receives revenues from other various local sources. A few of these local sources are:

Cell Tower Revenue – cell tower revenue is derived from contracts related to cell tower facilities located on District properties. Budgetary calculations are based on current contracts applicable for the upcoming school year.

Other Local Revenue – sources include revenues received for document copying requests, ID badge replacements, transcript requests, and local school billing transactions, among others. Budgetary calculations are based on the average rate of collections from the three most recent completed fiscal years.

Sale of Assets – revenue from the sale of school assets may vary from year to year, depending on the assets that might be available for liquidation. Budgetary revenue is based on the average rate of collections from the three most recent completed fiscal years. In order to maintain the integrity of the average, one-time items, such as land sales, are excluded from the collections. This rate is then applied to the collections from the current fiscal year to determine the projected FY2020 revenue.

Facility Use – the District is aware of the importance of allowing community groups and sports organizations to use District facilities during non-school hours. This enables schools to be utilized to their maximum potential as groups adhere to guidelines set forth by the District. Budgetary calculations are based on historical trends and Budget Administrator input.

After School Program – a program provided to elementary schools that uses designated school facilities to provide supervision and enrichment to children in elementary schools from school release time until 6:00pm. Budgeted revenues are based on historical trends, Budget Administrator input, and enrollment projections.

Tuition School – provides the opportunity for students to make up school classes and provides enrichment and remedial work at various instructional levels. Budgetary revenues are calculated using historical trends and Budget Administrator input.

Public Safety – this program is funded by revenues received from parking decals sold to students, which pays for campus police officers for the schools. Budgetary revenues are calculated using historical trends and Budget Administrator input.

RELATIONSHIP OF ORGANIZATIONAL UNITS BY FUNCTION AND EXPENDITURE OBJECT CODE

Personnel of the Cobb County School District are organizationally classified according to the function that they perform for the District. The organizational chart has been coded with the appropriate function code and aligns with **Chart of Accounts** that set up by Financial Review Office of **Georgia DOE**. The classification of Expenditures and Revenues used in the district financial system as well as their definition have been listed below.

FUNCTION CODE

The function describes the activity for which a service or material is acquired. Functions include all activities or actions that are performed to accomplish the objectives of an enterprise. The functions of the school district are classified into five broad areas; Instruction, Support Services, Operation of Non-Instructional Services, Facilities Acquisition and Construction and Other Outlays. Functions are further divided into sub-functions and areas of responsibility.

<u>CODE</u>	<u>FUNCTION</u>
1000	<u>Instruction</u> Activities dealing directly with the interaction between teachers and students. Teaching may be provided for students in a school classroom, in another location such as a home or hospital, and in other learning situations such as those involving co-curricular activities. It may also be provided through some other approved medium such as television, radio, telephone, and correspondence. Included here are the activities of aides or classroom assistants of any type (clerks, graders, teaching machines, etc.) which assist in the instructional process. Note: Counselors and Technology Specialists funded through QBE are allowable charges to this function for expenditure control purposes.
2100	<u>Pupil Services</u> Activities designed to assess and improve the well-being of students and to supplement the teaching process. Activities include guidance, counseling, testing, attendance, social work, health services, etc. Also includes supplemental payments for additional duties such as coaching or supervising extracurricular activities.
2210	<u>Improvement of Instructional Services</u> Technical and logistical support activities designed to aid teachers in developing the curriculum, preparing and using special curriculum materials, and understanding the various techniques that stimulate and motivate students. These services facilitate, sustain, and enhance instruction techniques. Includes costs associated with technology personnel (Technology Specialists), contracted support services, systems planning and analysis, systems application development, network support services, and other technology-related costs that relate to the support of instructional activities. Effective FY 2018 – All Instructional Staff Training (professional development) costs will be reported using Function 2213. Training and professional development for other, non-instructional employees should be reported in their respective functions.
2220	<u>Educational Media Services</u> Activities concerned with directing, managing and operating educational media centers. Included are school libraries, audio-visual services and educational television.
2230	<u>Federal Grant Administration</u> Activities concerned with the demands of Federal Programs grant management. Federal Indirect Cost Charges should continue to be charged to 2300-880.

**RELATIONSHIP OF ORGANIZATIONAL UNITS
BY FUNCTION AND EXPENDITURE OBJECT CODE (continued)**

- 2300 General Administration Activities concerned with establishing and administering policy for operating the LUA. These include the activities of the members of the Board of Education. Local activities in interpretation of the laws and statutes and general liability situations are charged here, as are the activities of external auditors. Also recorded here are activities performed by the superintendent, administrative support personnel and deputy, associate, or assistant superintendent having overall administrative responsibility.
- 2400 School Administration Activities concerned with overall administrative responsibility for school operations. Included are activities of principals, assistant principals, full time department chairpersons and clerical staff.
- 2500 Support Services-Business Activities concerned with the fiscal operation of the LUA, including budgeting, financial and property accounting, payroll, inventory control, internal auditing and managing funds. Also included are purchasing, warehouse and distribution operations, and printing, publishing and duplicating operations.
- 2600 Maintenance and Operation of Plant Services Activities concerned with keeping the physical plant open, comfortable, and safe for use, and keeping the grounds, buildings, and equipment in effective working condition and state of repair. This includes the activities of maintaining safety in buildings, on the grounds, and in the vicinity of schools. Property insurance expenditures are recorded in this function.
- 2700 Student Transportation Activities concerned with the conveyance of students to and from school and trips to school activities. These activities include supervision of student transportation, vehicle operation, servicing and maintenance, bus monitoring and traffic direction. Transportation insurance expenditures are charged to this function.
- 2800 Support Services-Central Central Office activities other than general administration and business services. Included are personnel services, data processing services, strategic planning including research, development and evaluation on a system-wide basis; and public relations activities, such as writing, editing and other preparation necessary to disseminate information to students, staff and the general public.
- 2900 Other Support Services All other support services not properly classified elsewhere in the 2000 series.
- 3100 School Nutrition Program Activities concerned with providing food to students and staff in a school or LUA. This service area includes the preparation and serving of regular and incidental meals or snacks in connection with school activities and delivery of food. Activities should be recorded in Fund 600 (School Nutrition Program) except when paid by federal funds from fund 100 on behalf of the food service operation due to a shortage of funds or by special arrangement.
- 3200 Enterprise Operations Activities that are financed and operated in a manner similar to private business enterprises - where the intent is to recover costs through user charges. Examples: LUA operated bookstore, cannery or freezer plant operation, stadium operation, etc.
- 3300 Community Services Operations Activities concerned with providing community services to students, staff or other community participants. Examples of this function would be the operation of a community swimming pool, a recreation program for the elderly, a child care center for working mothers, etc.

**RELATIONSHIP OF ORGANIZATIONAL UNITS
BY FUNCTION AND EXPENDITURE OBJECT CODE (continued)**

- 4000 Facilities Acquisition and Construction Services Activities concerned with the acquisition of land and buildings; renovating buildings; the construction of buildings and additions to buildings, initial installation or extension of service systems and other build-in equipment; and improvements to sites.
- 5000 Other Outlays Outlays which cannot be properly classified as expenditures, but require budgetary or accounting control. Transfers to other funds are recorded as 5000-930.
- 5100 Debt Service Outlays to retire the long-term debt (obligations in excess of one year) of the LUA. Included are payments of principal, interest and paying agents' fees. Interest on current loans (repayable within one year) is charged to function 2500.

OBJECT CODE

The object code is used to describe the service or commodity obtained as a result of a specific expenditure. There are several major object categories which may be further subdivided for *Personnel Expenditures* and *Operational Expenditures*:

<u>CODE</u>	<u>OBJECT</u>
511010-519910	<u>Salaries</u> Salary paid to all school district related personnel
521010-529020	<u>Benefits</u> Expenditures on behalf of the employees. These amounts are not included in the gross salary, but are in excess of that amount. Such payments are fringe benefit payments and, while not paid directly to employees, are part of the cost of personnel services. The employee benefit applicable to any salary should be charged directly to the function to which the salary was charged. Employer benefits should include, but are not limited to, group insurance, social security, retirement, workers compensation, unemployment compensation and annuity plans.
530010-533210	<u>Contract Services</u> Service which can be performed only by persons or firms with specialized skills and knowledge. While a product may or may not result from the transaction, the primary reason for the purchase is the service provided. Included are the services and travel of architects, engineers, auditors, dentists, medical doctors, lawyers, consultants, teachers, accountants, etc.
541000-549010	<u>Repair and Rental</u> Expenditures for repairs and maintenance services. This includes contracts and agreements covering the upkeep of buildings and equipment as well as technology hardware. Costs for renovating and remodeling are not included here. Expenditures for leasing or renting land, building, equipment or vehicles, etc., for both temporary and long-range use.
551910-559600	<u>Other Purchases</u> Expenditures for district property, assets insurances, health claims, general liability, telephone expenses, tuition to other sources, employee travel, and service purchase from other entities, etc.
561010-564220	<u>Supplies and Equipment</u> All supply items and equipment. Office supplies, paper, cleaning supplies, expendable equipment; food acquisitions and support items for district food services; technology related supplies, software, and computers less than \$5000. This category also includes gasoline, diesel fuel, and utilities of gas, electricity.

**RELATIONSHIP OF ORGANIZATIONAL UNITS
BY FUNCTION AND EXPENDITURE OBJECT CODE (continued)**

581010-589050	<u>Dues and Other Fees</u> Include registration, dues, bank service charges, interest expense, litigation, and other fees.
593010-599999	<u>Transfers</u> Transfer to other funds.
661530-664210	<u>Fixed Assets Equipt</u> Equipment, textbooks-depreciable and non-depreciable, books and periodicals.
671020-678100	<u>Fixed Assets CIP</u> Land acquisition, building, site improvements, construction, bud purchases, capital outlay, technology related and fix assets depreciation, intangible amortization.
693010	<u>Transfer between Funds</u> All transfer between district funds.

Financial Section

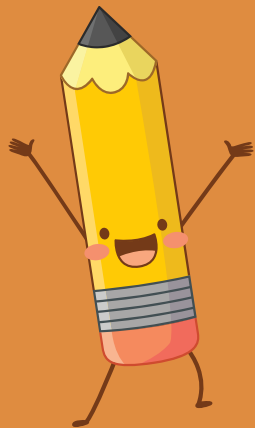

**COBB COUNTY SCHOOL DISTRICT
FY2023 BOARD OF EDUCATION ADOPTED BUDGET
CONSOLIDATED BUDGET STATEMENT**

The FY2023 consolidated budget presented below is for informational purposes only. While informative, this consolidated statement shows mixed types of funds. It does not represent an operational statement of the District, but merely a total of all budget types within.

Description	General Fund	Special Revenue	Debt Services	Capital Project	Internal Service	Total All Funds
Beginning Fund Balance						
July 1 (Estimated)	\$381,278,568	\$38,424,786	\$0	\$116,513,029	\$7,641,842	\$543,858,224
Revenue:						
Local	\$710,189,797	\$35,395,025	\$0	\$158,273,911	\$6,474,765	\$910,333,498
State	\$584,111,998	\$5,792,766	\$0	\$2,400,432	\$0	\$592,305,196
Federal	\$8,692,647	\$88,560,626	\$0	\$0	\$0	\$97,253,273
Transfers/Other	\$415,000	\$1,770,200	\$0	\$1,000,000	\$0	\$3,185,200
Total Revenue:	\$1,303,409,442	\$131,518,617	\$0	\$161,674,343	\$6,474,765	\$1,603,077,167
Total Revenue & Fund Balance	\$1,684,688,010	\$169,943,403	\$0	\$278,187,372	\$14,116,607	\$2,146,935,391
Appropriations:						
Instruction	\$965,877,709	\$28,481,078	\$0	\$0	\$0	\$994,358,787
Pupil Support Services	\$32,915,803	\$5,594,463	\$0	\$0	\$0	\$38,510,266
Improvement of Instructional Serv	\$29,702,800	\$9,140,005	\$0	\$0	\$0	\$38,842,805
Educational Media Services	\$21,720,665	\$7,748	\$0	\$0	\$0	\$21,728,413
Instructional Staff Training	\$0	\$11,808,290	\$0	\$0	\$0	\$11,808,290
Federal Grant Administration	\$0	\$977,748	\$0	\$0	\$0	\$977,748
General Administration	\$13,805,073	\$1,841,370	\$0	\$0	\$0	\$15,646,443
School Administration	\$80,555,744	\$24,545	\$0	\$0	\$0	\$80,580,289
Support Services - Business	\$11,014,358	\$28,173	\$0	\$0	\$6,450,765	\$17,493,296
Maintenance and Operation of Plant Serv	\$83,862,800	\$2,009,027	\$0	\$0	\$0	\$85,871,827
Student Transportation	\$64,112,380	\$1,746,936	\$0	\$0	\$0	\$65,859,316
Support Services - Central	\$25,848,109	\$163,749	\$0	\$0	\$0	\$26,011,858
Other Support Services	\$654,540	\$20,693	\$0	\$0	\$0	\$675,233
School Nutrition Program	\$0	\$63,042,378	\$0	\$0	\$0	\$63,042,378
Enterprise Operations	\$0	\$0	\$0	\$0	\$24,000	\$24,000
Community Services Operations	\$420,348	\$11,146,581	\$0	\$0	\$0	\$11,566,929
Capital Outlays	\$0	\$0	\$0	\$123,598,996	\$0	\$123,598,996
Other Outlays	\$2,770,200	\$0	\$0	\$1,000,000	\$0	\$3,770,200
Debt Service	\$0	\$0	\$0	\$0	\$0	\$0
Total Appropriations	\$1,333,260,529	\$136,032,784	\$0	\$124,598,996	\$6,474,765	\$1,600,367,074
Ending Fund Balance	\$351,427,481	\$33,910,619	\$0	\$153,588,376	\$7,641,842	\$546,568,317
June 30 (Estimated)						
Total Expenditures & Fund Balance	\$1,684,688,010	\$169,943,403	\$0	\$278,187,372	\$14,116,607	\$2,146,935,391

FUND DESCRIPTIONS

- The **General Fund** is the District's primary operating fund. It accounts for all financial resources of the general government, except those required to be accounted for in another fund.
- The **Special Revenue Fund** is used to account for the proceeds of specific revenue sources that are legally restricted to expenditures for specified purposes.
- The **Debt Service Fund** accounts for the accumulation of resources for, and the payment of, general long-term debt principal, interest and related costs.
- The **Capital Project Fund** accounts for financial resources used for the acquisition and construction of major capital facilities.
- The **Internal Service Fund** is used to account for the financing of goods or services provided by one department to other departments on a cost-reimbursement basis.

**ALL FUNDS COMBINED BUDGET SUMMARY
REVENUE AND APPROPRIATIONS (FUNCTION)
EIGHT YEAR COMPARISON**

Description	FY2019 Actual	FY2020 Actual	FY2021 Actual	FY2022 Revised Budget	FY2023 Approved Budget	FY2024 Forecast	FY2025 Forecast	FY2026 Forecast
Beginning Fund Balance July 1 (Estimated)	\$287,897,079	\$313,779,514	\$283,499,311	\$410,530,710	\$543,858,224	\$546,568,317	\$543,463,487	\$577,905,297
Revenue:								
Local	\$747,352,509	\$772,390,594	\$802,479,617	\$847,948,002	\$910,333,498	\$934,960,607	\$985,280,135	\$1,025,984,486
State	\$549,113,303	\$619,581,979	\$566,912,268	\$555,265,838	\$592,305,196	\$590,137,237	\$594,228,244	\$592,637,937
Federal	\$88,637,695	\$84,316,337	\$208,382,738	\$299,347,701	\$97,253,273	\$95,692,979	\$95,692,979	\$95,692,979
Transfers/Other	\$25,168,022	\$11,360,558	\$10,626,386	\$7,529,202	\$3,185,200	\$2,770,200	\$2,770,200	\$2,770,200
Total Revenue	\$1,410,271,529	\$1,487,649,468	\$1,588,401,009	\$1,710,090,743	\$1,603,077,167	\$1,623,561,023	\$1,677,971,558	\$1,717,085,602
Total Revenue & Fund Balance	\$1,698,168,608	\$1,801,428,982	\$1,871,900,320	\$2,120,621,453	\$2,146,935,391	\$2,170,129,341	\$2,221,435,046	\$2,294,990,900
Appropriations								
Instruction	\$792,229,907	\$852,144,040	\$868,455,978	\$1,060,514,393	\$994,358,787	\$1,377,267,143	\$1,393,003,062	\$1,409,452,520
Pupil Support Services	\$36,096,063	\$42,587,778	\$37,983,631	\$38,957,874	\$38,510,266	\$5,594,463	\$5,594,463	\$5,594,463
Improvement of Instr Svcs	\$27,975,043	\$28,737,013	\$31,266,143	\$46,263,807	\$38,842,805	\$9,140,005	\$9,140,005	\$9,140,005
Educational Media Services	\$16,509,872	\$17,737,452	\$17,394,148	\$20,442,543	\$21,728,413	\$7,748	\$7,748	\$7,748
Instructional Staff Training	\$10,970,947	\$10,394,747	\$10,030,378	\$15,172,658	\$11,808,290	\$11,808,290	\$11,808,290	\$11,808,290
Federal Grant Administration	\$822,828	\$835,343	\$820,325	\$1,036,215	\$977,748	\$977,748	\$977,748	\$977,748
General Administration	\$13,907,079	\$14,370,110	\$14,426,767	\$33,763,333	\$15,646,443	\$1,841,370	\$1,841,370	\$1,841,370
School Administration	\$70,951,774	\$77,172,805	\$77,882,080	\$78,196,939	\$80,580,289	\$24,545	\$24,545	\$24,545
Support Services-Business	\$15,844,112	\$15,980,965	\$15,902,684	\$18,699,996	\$17,493,296	\$6,575,699	\$6,673,912	\$6,773,598
Maint. & Oper of Plant Svcs	\$72,507,260	\$82,368,432	\$79,148,729	\$81,419,108	\$85,871,827	\$2,009,027	\$2,009,027	\$2,009,027
Student Transportation	\$56,583,688	\$57,699,793	\$51,593,665	\$65,101,410	\$65,859,316	\$1,746,936	\$1,746,936	\$1,746,936
Support Services - Central	\$21,461,583	\$19,266,591	\$27,092,886	\$24,787,922	\$26,011,858	\$163,749	\$163,749	\$163,749
Other Support Services	\$508,920	\$819,720	\$1,353,413	\$1,138,403	\$675,233	\$20,693	\$20,693	\$20,693
School Nutrition Program	\$57,019,410	\$55,250,724	\$45,633,494	\$72,235,833	\$63,042,378	\$63,042,378	\$63,042,378	\$63,042,378
Enterprise Operations	\$0	\$5,212	\$9,717	\$70,000	\$24,000	\$24,000	\$24,000	\$24,000
Community Services	\$9,128,884	\$7,558,305	\$4,202,542	\$8,605,669	\$11,566,929	\$11,146,581	\$11,146,581	\$11,146,581
Capital Outlay	\$174,974,295	\$221,889,909	\$165,383,569	\$137,192,661	\$123,598,996	\$134,275,478	\$135,305,241	\$134,029,804
Transfers	\$6,897,428	\$6,058,644	\$11,123,836	\$6,962,521	\$3,770,200	\$1,000,000	\$1,000,000	\$1,000,000
Debt Service	\$0	\$0	\$0	\$0	\$0	\$0	\$0	\$0
Total Appropriations	\$1,384,389,094	\$1,510,877,583	\$1,459,703,982	\$1,710,561,285	\$1,600,367,074	\$1,626,665,853	\$1,643,529,748	\$1,658,803,455
Ending Fund Balance June 30 (Estimated)	\$313,779,514	\$290,551,399	\$412,196,338	\$410,060,168	\$546,568,317	\$543,463,487	\$577,905,297	\$636,187,444
Total Expenditures & Fund Balance	\$1,698,168,608	\$1,801,428,982	\$1,871,900,320	\$2,120,621,453	\$2,146,935,391	\$2,170,129,341	\$2,221,435,046	\$2,294,990,900

Note A: The Board of Education approved Fiscal Year 2023 Budget that includes the use of \$29.8 Million General Fund fund balance to help offset one-time cost and balance the budget.

**COBB COUNTY SCHOOL DISTRICT
FISCAL YEAR 2023 REVENUE – ALL FUNDS**

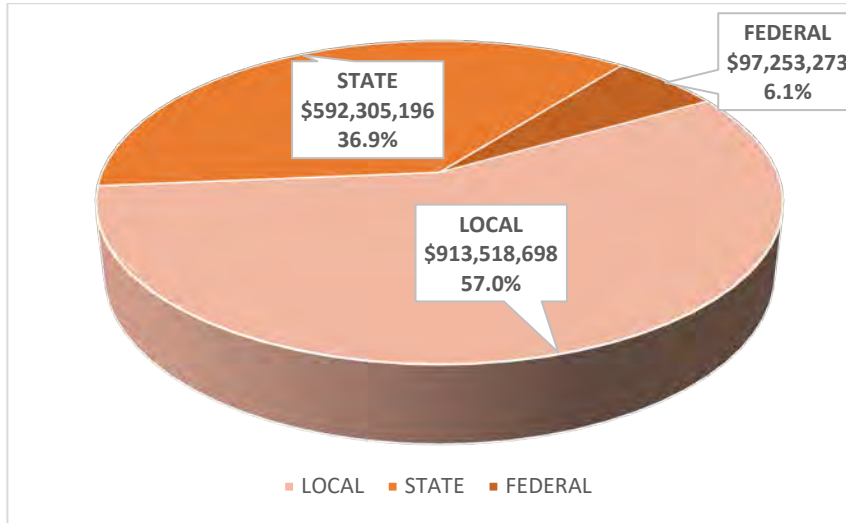

TOTAL REVENUE - \$1,603,077,167

**COBB COUNTY SCHOOL DISTRICT
FISCAL YEAR 2023 EXPENDITURES – ALL FUNDS**

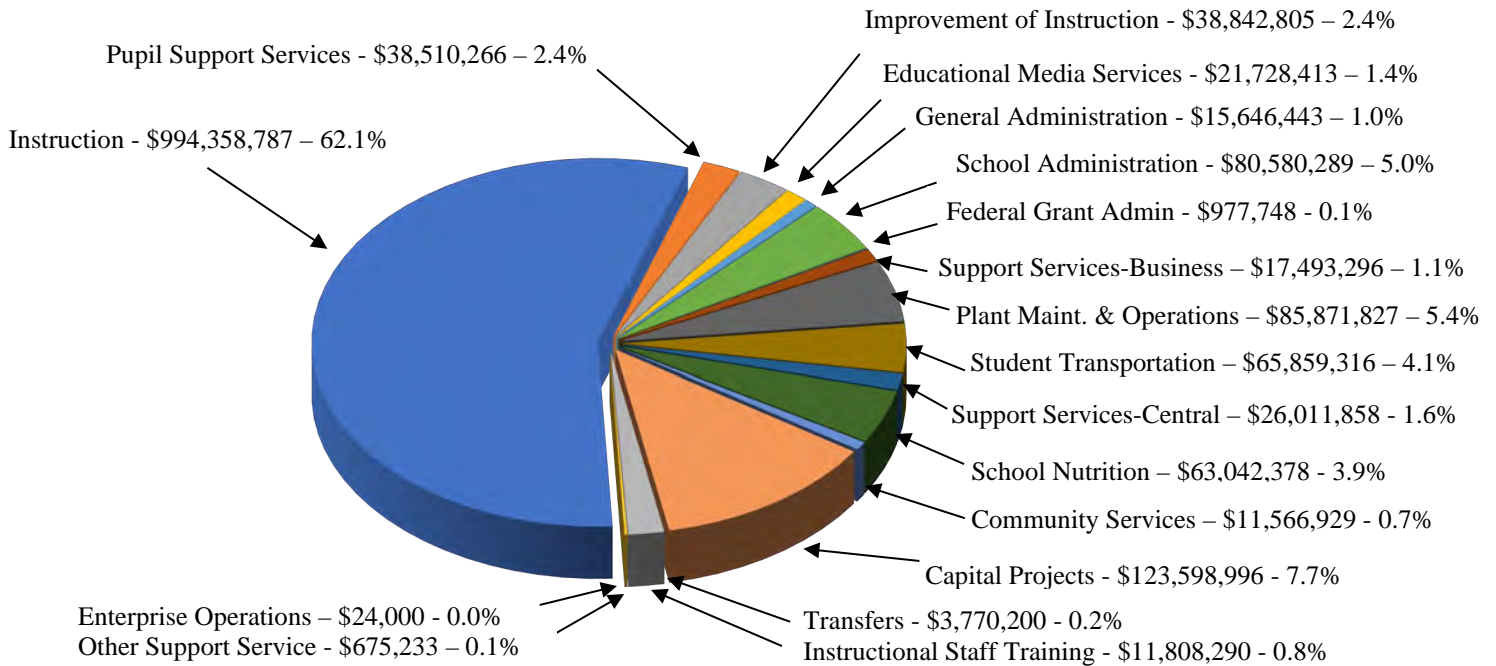

TOTAL EXPENDITURES - \$1,600,367,074

**EXECUTIVE SUMMARY
COBB COUNTY SCHOOL DISTRICT
FIVE YEARS GENERAL FUND FORECAST**

Type	Category	FY2022 Board Approved Revised Budget	FY2023	FY2024	FY2025	FY2026	FY2027	FY2028	Assumptions														
1 Local	Property Tax Revenue	\$564,026,799	\$629,045,845	\$660,498,137	\$693,523,044	\$728,199,196	\$764,609,156	\$802,839,614	<table border="1"> <tr> <th colspan="2">Property Digest Information</th> </tr> <tr> <td>FY2023 Projected Digest</td> <td>10.49%</td> </tr> <tr> <td>FY2024 Projected Digest</td> <td>5.00%</td> </tr> <tr> <td>FY2025 Projected Digest</td> <td>5.00%</td> </tr> <tr> <td>FY2026 Projected Digest</td> <td>5.00%</td> </tr> <tr> <td>FY2027 Projected Digest</td> <td>5.00%</td> </tr> <tr> <td>FY2028 Projected Digest</td> <td>5.00%</td> </tr> </table>	Property Digest Information		FY2023 Projected Digest	10.49%	FY2024 Projected Digest	5.00%	FY2025 Projected Digest	5.00%	FY2026 Projected Digest	5.00%	FY2027 Projected Digest	5.00%	FY2028 Projected Digest	5.00%
Property Digest Information																							
FY2023 Projected Digest	10.49%																						
FY2024 Projected Digest	5.00%																						
FY2025 Projected Digest	5.00%																						
FY2026 Projected Digest	5.00%																						
FY2027 Projected Digest	5.00%																						
FY2028 Projected Digest	5.00%																						
2	Other Tax Revenue	\$66,872,353	\$77,043,779	\$77,043,779	\$77,043,779	\$77,043,779	\$77,043,779	\$77,043,779	Constant														
3	Other Local	\$4,578,960	\$4,515,173	\$4,515,173	\$4,515,173	\$4,515,173	\$4,515,173	\$4,515,173	Constant														
4 State	Miscellaneous State Grant	\$6,208,120	\$5,599,461	\$5,599,461	\$5,599,461	\$5,599,461	\$5,599,461	\$5,599,461	Constant														
5	QBE	\$535,357,204	\$578,512,537	\$578,512,537	\$578,512,537	\$578,512,537	\$578,512,537	\$578,512,537	Constant														
6 Federal	Indirect Cost	\$4,006,460	\$5,606,481	\$4,517,147	\$4,517,147	\$4,517,147	\$4,517,147	\$4,517,147	Constant														
7	ROTC	\$1,204,272	\$1,239,971	\$1,072,281	\$1,072,281	\$1,072,281	\$1,072,281	\$1,072,281	Constant														
8	MedAce	\$1,117,141	\$1,138,479	\$985,295	\$985,295	\$985,295	\$985,295	\$985,295	Constant														
9	Medicaid	\$689,545	\$707,716	\$557,630	\$557,630	\$557,630	\$557,630	\$557,630	Constant														
10	Revenue Total	\$1,184,060,854	\$1,303,409,442	\$1,333,301,440	\$1,366,326,347	\$1,401,002,499	\$1,437,412,459	\$1,475,642,917															
11	Reserve Available	\$71,687,571	\$29,851,087	\$-	\$-	\$-	\$-	\$-															
	Total Funds Available	\$1,255,748,425	\$1,333,260,529	\$1,333,301,440	\$1,366,326,347	\$1,401,002,499	\$1,437,412,459	\$1,475,642,917															
12 Base	FY22 Revised Budget	\$1,255,748,425																					
13	FY23 Proposed Budget		\$1,333,260,529																				
14	Prior Year Continuation Budget			\$1,333,260,529	\$1,348,786,065	\$1,364,521,984	\$1,380,971,442	\$1,398,137,641															
15 Salary/Benefits	Annual Step Increase			\$14,025,536	\$14,235,919	\$14,449,458	\$14,666,200	\$14,886,193	Annual Step Increase for All Eligible Employees Estimated based on historical trends														
16	Increased Benefit Cost			\$1,500,000	\$1,500,000	\$2,000,000	\$2,500,000	\$3,000,000															
12 Base	FY22 Loan to SPLOST6	\$3,464,951																					
	Expenditure Total	\$1,259,213,376	\$1,333,260,529	\$1,348,786,065	\$1,364,521,984	\$1,380,971,442	\$1,398,137,642	\$1,416,023,834															
	Forecasted (Deficit)/Surplus	(\$3,464,951) \$-		(\$15,484,625)	\$1,804,363	\$20,031,058	\$39,274,818	\$59,619,083															

Conservative Budget Practices – Cobb County School District utilizes realistic, but conservative, budgeting practices when developing the annual budget, in both Revenue and Expenditure estimates. Regarding revenues, these estimates could include budgeting the lower amount of a given range of estimated receipts or being cautiously optimistic about the amount of revenues to be received from a given source, among other factors. For expenditures, these assumptions could include budgeting for all positions to be filled for the full year, assuming all new employees will elect health insurance coverage, and budgeting Teachers' salaries at an average amount. Due to the conservative nature of CCSD's budgeting practices, budgeted expenditures may exceed budgeted revenues in a given fiscal year, resulting in a forecasted usage of fund balance.

**COBB COUNTY SCHOOL DISTRICT
OTHER FUNDS FORECAST**

Fund	Beginning Fund Balance July 1, 2021	FY2022			FY2023			FY2024			FY2025			FY2026			Forecast Assumptions and Comments	
		Budget Revenue	Budget Expenditures	Ending Fund Balance June 30, 2022	Budget Revenue	Budget Expenditures	Ending Fund Balance June 30, 2023	Budget Revenue	Budget Expenditures	Ending Fund Balance June 30, 2024	Budget Revenue	Budget Expenditures	Ending Fund Balance June 30, 2025	Budget Revenue	Budget Expenditures	Ending Fund Balance June 30, 2026		
SPECIAL REVENUE FUNDS																		
Federal Aid																		
402	Title I	\$0	\$24,977,323	\$24,977,323	\$0	\$21,541,138	\$21,541,138	\$0	\$21,541,138	\$21,541,138	\$0	\$21,541,138	\$21,541,138	\$0	\$21,541,138	\$21,541,138	\$0	Grants are initially budgeted with last year amount
404	Special Education IDEA	\$0	\$27,939,790	\$27,939,790	\$0	\$21,945,218	\$21,945,218	\$0	\$21,945,218	\$21,945,218	\$0	\$21,945,218	\$21,945,218	\$0	\$21,945,218	\$21,945,218	\$0	Grants are initially budgeted with last year amount
406	Vocation Education CTAE	\$0	\$868,526	\$868,526	\$0	\$780,716	\$780,716	\$0	\$780,716	\$780,716	\$0	\$780,716	\$780,716	\$0	\$780,716	\$780,716	\$0	Grants are initially budgeted with last year amount
414	Title II - A	\$0	\$3,914,234	\$3,914,234	\$0	\$2,799,744	\$2,799,744	\$0	\$2,799,744	\$2,799,744	\$0	\$2,799,744	\$2,799,744	\$0	\$2,799,744	\$2,799,744	\$0	Grants are initially budgeted with last year amount
420	CARES Act	\$0	\$805,265	\$805,265	\$0	\$0	\$0	\$0	\$0	\$0	\$0	\$0	\$0	\$0	\$0	\$0	\$0	COVID 19 Relief Grant of FY2021
432	Homeless	\$0	\$709,599	\$709,599	\$0	\$83,380	\$83,380	\$0	\$83,380	\$83,380	\$0	\$83,380	\$83,380	\$0	\$83,380	\$83,380	\$0	Grants are initially budgeted with last year amount
448	American Rescue Plan Act	\$0	\$168,135,914	\$168,135,914	\$0	\$0	\$0	\$0	\$0	\$0	\$0	\$0	\$0	\$0	\$0	\$0	\$0	COVID 19 Relief Grant of FY2022
460	Title III - A	\$0	\$1,936,629	\$1,936,629	\$0	\$1,568,146	\$1,568,146	\$0	\$1,568,146	\$1,568,146	\$0	\$1,568,146	\$1,568,146	\$0	\$1,568,146	\$1,568,146	\$0	Grants are initially budgeted with last year amount
462	Title IV - B	\$0	\$4,104,479	\$4,104,479	\$0	\$2,403,073	\$2,403,073	\$0	\$2,403,073	\$2,403,073	\$0	\$2,403,073	\$2,403,073	\$0	\$2,403,073	\$2,403,073	\$0	Grants are initially budgeted with last year amount
478	USDA Fruit & Vegetable	\$0	\$183,211	\$183,211	\$0	\$183,211	\$183,211	\$0	\$183,211	\$183,211	\$0	\$183,211	\$183,211	\$0	\$183,211	\$183,211	\$0	Grants are initially budgeted with last year amount
600	School Nutrition	\$5,693,961	\$62,783,010	\$59,998,771	\$8,478,200	\$58,345,000	\$62,859,167	\$3,964,033	\$58,345,000	\$62,859,167	(\$550,134)	\$58,345,000	\$62,859,167	(\$5,064,301)	\$58,345,000	\$62,859,167	(\$9,578,468) *	Pending on Federal COVID rescue fund amount Project using 0% Student Growth
Special Programs																		
549	Donations	\$939,188	\$240,161	\$1,179,450	(\$101)	\$0	\$0	(\$101)	\$0	\$0	(\$101)	\$0	\$0	(\$101)	\$0	\$0	(\$101)	Donations are budgeted as received
550	Venue Management	\$466,101	\$823,809	\$908,809	\$381,101	\$1,500,000	\$1,500,000	\$381,101	\$1,500,000	\$1,500,000	\$381,101	\$1,500,000	\$1,500,000	\$381,101	\$1,500,000	\$1,500,000	\$381,101	Continue FY2023 Budget (balanced)
551	After School Program	\$2,152,420	\$7,814,902	\$8,504,634	\$1,462,688	\$10,774,828	\$10,774,828	\$1,462,688	\$10,774,828	\$10,774,828	\$1,462,688	\$10,774,828	\$10,774,828	\$1,462,688	\$10,774,828	\$10,774,828	\$1,462,688	Project using 0% Student Growth
552	Performing Arts	\$369,830	\$420,177	\$420,177	\$369,830	\$422,760	\$422,760	\$369,830	\$422,760	\$422,760	\$369,830	\$422,760	\$422,760	\$369,830	\$422,760	\$422,760	\$369,830	Continue FY2023 Budget (balanced)
553	Tuition School	\$2,250,317	\$1,399,702	\$1,399,702	\$2,250,317	\$1,399,702	\$1,399,702	\$2,250,317	\$1,399,702	\$1,399,702	\$2,250,317	\$1,399,702	\$1,399,702	\$2,250,317	\$1,399,702	\$1,399,702	\$2,250,317	Continue FY2023 Budget (balanced)
554	Public Safety	\$69,518	\$1,940,865	\$1,940,865	\$69,518	\$1,940,865	\$1,940,865	\$69,518	\$1,940,865	\$1,940,865	\$69,518	\$1,940,865	\$1,940,865	\$69,518	\$1,940,865	\$1,940,865	\$69,518	Continue FY2023 Budget (balanced)
556	Adult High School	\$425,008	\$300,470	\$300,470	\$425,008	\$300,470	\$300,470	\$425,008	\$300,470	\$300,470	\$425,008	\$300,470	\$300,470	\$425,008	\$300,470	\$300,470	\$425,008	Continue FY2023 Budget (balanced)
557	Art Career & Cultural Explore	\$16,325	\$2,600	\$2,600	\$16,325	\$2,600	\$2,600	\$16,325	\$2,600	\$2,600	\$16,325	\$2,600	\$2,600	\$16,325	\$2,600	\$2,600	\$16,325	Continue FY2023 Budget (balanced)
580	Miscellaneous Grants	\$158,803	\$390,535	\$390,535	\$158,803	\$145,000	\$145,000	\$158,803	\$145,000	\$145,000	\$158,803	\$145,000	\$145,000	\$158,803	\$145,000	\$145,000	\$158,803	Misc grants are budgeted as received
State Aid																		
510	Adult Education	\$0	\$1,236,800	\$1,236,800	\$0	\$1,164,700	\$1,164,700	\$0	\$1,164,700	\$1,164,700	\$0	\$1,164,700	\$1,164,700	\$0	\$1,164,700	\$1,164,700	\$0	Grants are initially budgeted using last year's
532	GNETS	\$182,931	\$4,143,934	\$4,143,934	\$182,931	\$3,839,122	\$3,839,122	\$182,931	\$3,839,122	\$3,839,122	\$182,931	\$3,839,122	\$3,839,122	\$182,931	\$3,839,122	\$3,839,122	\$182,931	Project using 0% Student Growth
560	Pre-Kindergarten (Lottery)	\$0	\$309,982	\$309,982	\$0	\$378,944	\$378,944	\$0	\$378,944	\$378,944	\$0	\$378,944	\$378,944	\$0	\$378,944	\$378,944	\$0	Continue FY2023 Budget (balanced)
TOTAL OF SPECIAL REVENUE FUNDS		\$12,724,402	\$315,381,917	\$314,311,699	\$13,794,620	\$131,518,617	\$136,032,784	\$9,280,453	\$131,518,617	\$136,032,784	\$4,766,286	\$131,518,617	\$136,032,784	\$252,119	\$131,518,617	\$136,032,784	(\$4,262,048)	
DEBT SERVICE FUND																		
200	Debt Service	\$0	\$0	\$0	\$0	\$0	\$0	\$0	\$0	\$0	\$0	\$0	\$0	\$0	\$0	\$0	\$0	<u>Debt Payoff Comment</u> School District Bonded Debt was paid off FY2007
INTERNAL SERVICE FUNDS																		
691	Unemployment	\$6,431	\$300,000	\$300,000	\$6,431	\$300,000	\$300,000	\$6,431	\$300,000	\$300,000	\$6,431	\$300,000	\$300,000	\$6,431	\$300,000	\$300,000	\$6,431	Continue FY2023 Budget (balanced)
692	Self Insurance	\$6,841,829	\$6,150,765	\$7,204,189	\$5,788,405	\$6,150,765	\$6,150,765	\$5,788,405	\$6,150,765	\$6,150,765	\$5,788,405	\$6,150,765	\$6,150,765	\$5,788,405	\$6,150,765	\$6,150,765	\$5,788,405	Continue FY2023 Budget (balanced)
693	FNS Catered Food Services	\$17,722	\$70,000	\$70,000	\$17,722	\$24,000	\$24,000	\$17,722	\$24,000	\$24,000	\$17,722	\$24,000	\$24,000	\$17,722	\$24,000	\$24,000	\$17,722	Continue FY2023 Budget (balanced)
TOTAL OF INTERNAL SERVICE FUND		\$6,865,982	\$6,520,765	\$7,574,189	\$5,812,558	\$6,474,765	\$6,474,765	\$5,812,558	\$6,474,765	\$6,474,765	\$5,812,558	\$6,474,765	\$6,474,765	\$5,812,558	\$6,474,765	\$6,474,765	\$5,812,558	
CAPITAL PROJECTS FUNDS																		
	SPLOST and District-Wide	\$41,847,843	\$204,127,207	\$129,462,021	\$116,513,029	\$161,674,343	\$124,598,996	\$153,588,376	\$152,169,440	\$135,275,478	\$170,482,338	\$173,456,855	\$136,305,241	\$207,633,952	\$177,795,061	\$135,029,804	\$250,399,209	
TOTAL OF CAPITAL PROJECT FUNDS		\$41,847,843	\$204,127,207	\$129,462,021	\$116,513,029	\$161,674,343	\$124,598,996	\$153,588,376	\$152,169,440	\$135,275,478	\$170,482,338	\$173,456,855	\$136,305,241	\$207,633,952	\$177,795,061	\$135,029,804	\$250,399,209	
TOTAL OF OTHER FUNDS		\$61,438,227	\$526,029,889	\$451,347,909	\$136,120,207	\$299,667,725	\$267,106,545	\$168,681,387	\$290,162,822	\$277,783,027	\$181,061,182	\$311,450,237	\$278,812,790	\$213,698,629	\$315,788,443	\$277,537,353	\$251,949,719	

Note: The Georgia Legislature passed a law allowing school districts to establish a one-cent sales tax that would be used for capital projects or debt retirement. The passage of this sales tax assists the school district in building new schools, supplying additional classrooms and equipment and technology needs of a growing school district. Cobb County Citizens voted to approve SPLOST 1 (1999-2003), SPLOST 2 (2004-2008), SPLOST 3 (2009-2013), SPLOST 4 (2014-2018), SPLOST 5 (2019-2023), SPLOST 6 (2024-2028). SPLOST 5 was approved on March 21, 2017 for another five year plan starting from January 1, 2019, ends on December 31, 2023. SPLOST 6 was approved on November 2, 2021 for another five year plan starting from January 1, 2024, ends on December 31, 2028. **SPLOST 5 Tax Revenue Forecast** is presented on a separate page in next.



**COBB COUNTY SCHOOL DISTRICT
SPLOST 5 REVENUE FORECAST**

**COBB COUNTY SCHOOL DISTRICT
SPECIAL PURPOSE LOCAL OPTION SALES TAX REVENUES**

	2019	2020	2021	2022	2023	2024
Jan		15,102,258	15,328,660	15,601,300	15,880,696	16,137,960
Feb	11,448,617	11,691,230	11,866,495	12,077,557	12,293,848	
March	11,862,832	12,114,222	12,295,829	12,514,527	12,738,643	
April	12,808,680	13,045,759	13,257,231	13,496,132	13,729,586	
May	12,534,357	12,766,359	12,973,300	13,207,086	13,435,540	
June	12,978,130	13,218,345	13,432,614	13,674,676	13,911,219	
July	12,786,570	12,992,281	13,215,435	13,456,812	13,681,375	
Aug	12,966,263	13,174,865	13,401,154	13,645,924	13,873,643	
Sept	12,790,472	12,996,246	13,219,467	13,460,918	13,685,549	
Oct	13,140,680	13,328,075	13,561,878	13,813,035	14,035,120	
Nov	12,775,751	12,957,941	13,185,252	13,429,435	13,645,351	
Dec	12,850,301	13,033,555	13,262,191	13,507,798	13,724,975	
Yr. Total	138,942,653	156,421,136	158,999,506	161,885,200	164,635,545	16,137,960
						797,022,000

Implement Financial Plan



General Fund

GENERAL FUND BUDGET

The General Fund is used to account for all transactions related to the District's operations except those required to be accounted for in other funds. Major revenue sources include local property taxes and State Quality Basic Education Funds. Expenditures include all costs relating to the day-to-day operations of the District except those expenditures for programs funded by Federal, State and Local sources for designated purposes, payment of bonded debt, capital facility acquisition and construction.

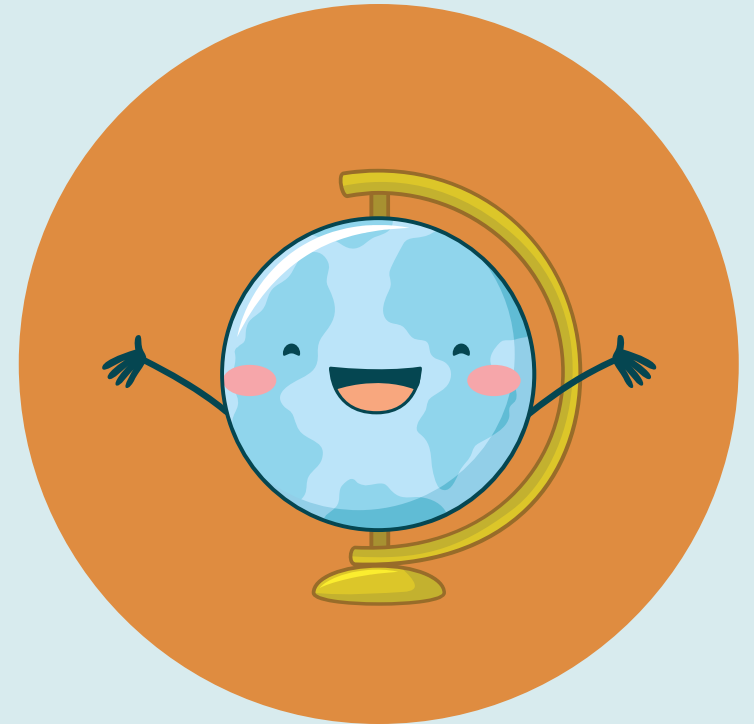

**GENERAL FUND BUDGET
REVENUE AND APPROPRIATIONS (FUNCTION)
EIGHT YEAR COMPARISON**

	FY2019	FY2020	FY2021	FY2022	FY2023	FY2024	FY2025	FY2026
Description	Actual	Actual	Actual	Revised Budget	Approved Budget	Forecast	Forecast	Forecast
Beginning Fund Balance July 1 (Estimated)	\$140,225,197	\$187,684,309	\$224,564,982	\$349,048,377	\$381,278,568	\$351,427,481	\$335,942,856	\$337,747,219
Revenue:								
Local	\$556,557,341	\$589,059,234	\$622,871,785	\$635,478,112	\$710,189,797	\$742,057,089	\$775,081,996	\$809,758,148
State	\$539,399,971	\$595,661,939	\$559,064,448	\$541,565,324	\$584,111,998	\$584,111,998	\$584,111,998	\$584,111,998
Federal	\$6,435,056	\$7,623,844	\$5,287,232	\$7,017,418	\$8,692,647	\$7,132,353	\$7,132,353	\$7,132,353
Transfers/Other	\$20,720,653	\$425,900	\$361,898	\$0	\$415,000	\$0	\$0	\$0
Total Revenue	\$1,123,113,021	\$1,192,770,917	\$1,187,585,363	\$1,184,060,854	\$1,303,409,442	\$1,333,301,440	\$1,366,326,347	\$1,401,002,499
Total Revenue & Fund Balance	\$1,263,338,218	\$1,380,455,226	\$1,412,150,345	\$1,533,109,231	\$1,684,688,010	\$1,684,728,921	\$1,702,269,203	\$1,738,749,718
Appropriations								
Instruction	\$767,179,590	\$823,970,271	\$735,123,184	\$897,294,136	\$965,877,709	\$1,348,786,065	\$1,364,521,984	\$1,380,971,442
Pupil Support Services	\$27,644,624	\$36,978,456	\$32,853,604	\$30,048,864	\$32,915,803	\$0	\$0	\$0
Improvement of Instr Svcs	\$20,555,846	\$20,522,078	\$22,509,888	\$30,545,974	\$29,702,800	\$0	\$0	\$0
Educational Media Services	\$16,509,872	\$17,737,452	\$17,178,577	\$20,434,795	\$21,720,665	\$0	\$0	\$0
Instructional Staff Training	\$0	\$0	\$25,000	\$0	\$0	\$0	\$0	\$0
Federal Grant Administration	\$0	\$0	\$0	\$0	\$0	\$0	\$0	\$0
General Administration	\$12,099,852	\$12,218,435	\$12,300,716	\$17,263,558	\$13,805,073	\$0	\$0	\$0
School Administration	\$70,788,630	\$76,988,456	\$76,708,541	\$77,598,829	\$80,555,744	\$0	\$0	\$0
Support Services-Business	\$8,047,140	\$8,593,520	\$9,106,030	\$10,759,766	\$11,014,358	\$0	\$0	\$0
Maint. & Oper of Plant Svcs	\$70,851,266	\$80,257,533	\$76,366,351	\$77,963,665	\$83,862,800	\$0	\$0	\$0
Student Transportation	\$55,013,442	\$55,801,174	\$48,533,506	\$59,866,547	\$64,112,380	\$0	\$0	\$0
Support Services - Central	\$21,140,072	\$18,877,448	\$19,497,511	\$23,768,896	\$25,848,109	\$0	\$0	\$0
Other Support Services	\$475,394	\$740,940	\$480,580	\$1,062,941	\$654,540	\$0	\$0	\$0
School Nutrition Program	\$385,774	\$471,237	\$477,063	\$0	\$0	\$0	\$0	\$0
Enterprise Operations	\$0	\$0	\$0	\$0	\$0	\$0	\$0	\$0
Community Services	\$90,314	\$97,816	\$97,819	\$101,934	\$420,348	\$0	\$0	\$0
Facility Acq & Construct Svc	\$2,371,745	\$14,245	\$1,808,730	\$6,268,320	\$0	\$0	\$0	\$0
Transfers	\$2,500,349	\$3,019,383	\$8,325,132	\$6,235,151	\$2,770,200	\$0	\$0	\$0
Debt Service	\$0	\$0	\$0	\$0	\$0	\$0	\$0	\$0
Total Appropriations	\$1,075,653,909	\$1,156,288,445	\$1,061,392,233	\$1,259,213,376	\$1,333,260,529	\$1,348,786,065	\$1,364,521,984	\$1,380,971,442
Ending Fund Balance June 30 (Estimated)	\$187,684,309	\$224,166,780	\$350,758,112	\$273,895,855	\$351,427,481	\$335,942,856	\$337,747,219	\$357,778,276
Total Expenditures & Fund Balance	\$1,263,338,218	\$1,380,455,226	\$1,412,150,345	\$1,533,109,231	\$1,684,688,010	\$1,684,728,921	\$1,702,269,203	\$1,738,749,718

Note A: The Board of Education approved Fiscal Year 2023 Budget that includes the use of \$29.8 Million General Fund fund balance to help offset one-time cost and balance the budget.
Note B: The expenditure forecasts of FY2024, FY2025, FY2026 have not yet been broken down by appropriations; therefore is presented as a total amount.

**GENERAL FUND BUDGET
REVENUE AND APPROPRIATIONS (OBJECT)
EIGHT YEAR COMPARISON**

Description	FY2019 Actual	FY2020 Actual	FY2021 Actual	FY2022 Revised Budget	FY2023 Approved Budget	FY2024 Forecast	FY2025 Forecast	FY2026 Forecast
Beginning Fund Balance July 1 (Estimated)	\$140,225,197	\$187,684,309	\$224,564,982	\$349,048,377	\$381,278,568	\$351,427,481	\$335,942,856	\$337,747,219
Revenue:								
Local	\$556,557,341	\$589,059,234	\$622,871,785	\$635,478,112	\$710,189,797	\$742,057,089	\$775,081,996	\$809,758,148
State	\$539,399,971	\$595,661,939	\$559,064,448	\$541,565,324	\$584,111,998	\$584,111,998	\$584,111,998	\$584,111,998
Federal	\$6,435,056	\$7,623,844	\$5,287,232	\$7,017,418	\$8,692,647	\$7,132,353	\$7,132,353	\$7,132,353
Transfers/Other	\$20,720,653	\$425,900	\$361,898	\$0	\$415,000	\$0	\$0	\$0
Total Revenue	\$1,123,113,021	\$1,192,770,917	\$1,187,585,363	\$1,184,060,854	\$1,303,409,442	\$1,333,301,440	\$1,366,326,347	\$1,401,002,499
Total Revenue & Fund Balance	\$1,263,338,218	\$1,380,455,226	\$1,412,150,345	\$1,533,109,231	\$1,684,688,010	\$1,684,728,921	\$1,702,269,203	\$1,738,749,718
Appropriations								
51 Salaries	\$693,740,784	\$751,315,352	\$690,418,268	\$812,146,356	\$892,976,766	\$907,002,302	\$921,238,221	\$935,687,679
52 Employee Benefits	\$293,315,423	\$322,936,659	\$288,274,948	\$341,853,249	\$355,546,201	\$357,046,201	\$358,546,201	\$360,546,201
53 Contract Services	\$13,115,191	\$11,239,446	\$9,628,407	\$6,557,046	\$6,045,457	\$0	\$0	\$0
54 Repair and Rental w Water	\$9,359,674	\$10,108,629	\$11,370,201	\$8,373,632	\$9,198,121	\$0	\$0	\$0
55 Other Purchases w Telephone	\$13,681,853	\$12,204,566	\$9,642,461	\$11,312,849	\$10,900,715	\$0	\$0	\$0
56 Supplies and Equipments w Utilitie	\$40,553,519	\$36,503,377	\$36,504,539	\$60,649,492	\$51,707,263	\$0	\$0	\$0
58 Dues and Other Fees	\$2,121,207	\$2,033,517	\$1,867,868	\$1,709,146	\$2,049,459	\$0	\$0	\$0
59 Transfers	\$2,500,349	\$3,019,383	\$8,332,132	\$6,235,151	\$2,770,200	\$0	\$0	\$0
66 Fixed Assets Equipt	\$1,957,423	\$2,154,684	\$3,983,636	\$8,707,881	\$671,753	\$0	\$0	\$0
67 Fixed Assets CIP w Bldgs/Land	\$4,336,475	\$3,788,324	\$433,367	\$306,260	\$50,500	\$0	\$0	\$0
68 Other	\$972,011	\$984,507	\$936,406	\$1,362,205	\$1,344,094	\$84,737,562	\$84,737,562	\$84,737,562
Total Appropriations	\$1,075,653,909	\$1,156,288,445	\$1,061,392,233	\$1,259,213,267	\$1,333,260,529	\$1,348,786,065	\$1,364,521,984	\$1,380,971,442
Ending Fund Balance June 30 (Estimated)	\$187,684,309	\$224,166,780	\$350,758,112	\$273,895,964	\$351,427,481	\$335,942,856	\$337,747,219	\$357,778,276
Total Expenditures & Fund Balance	\$1,263,338,218	\$1,380,455,226	\$1,412,150,345	\$1,533,109,231	\$1,684,688,010	\$1,684,728,921	\$1,702,269,203	\$1,738,749,718

Note A: The Board of Education approved Fiscal Year 2023 Budget that includes the use of \$29.8 Million General Fund fund balance to help offset one-time cost and balance the budget.

Note B: The expenditure forecasts of FY2024, FY2025, FY2026 have not yet been broken down by appropriations; therefore is presented as a total amount.

**GENERAL FUND
FIVE YEAR TREND OF FUND BALANCE**

\$ Millions

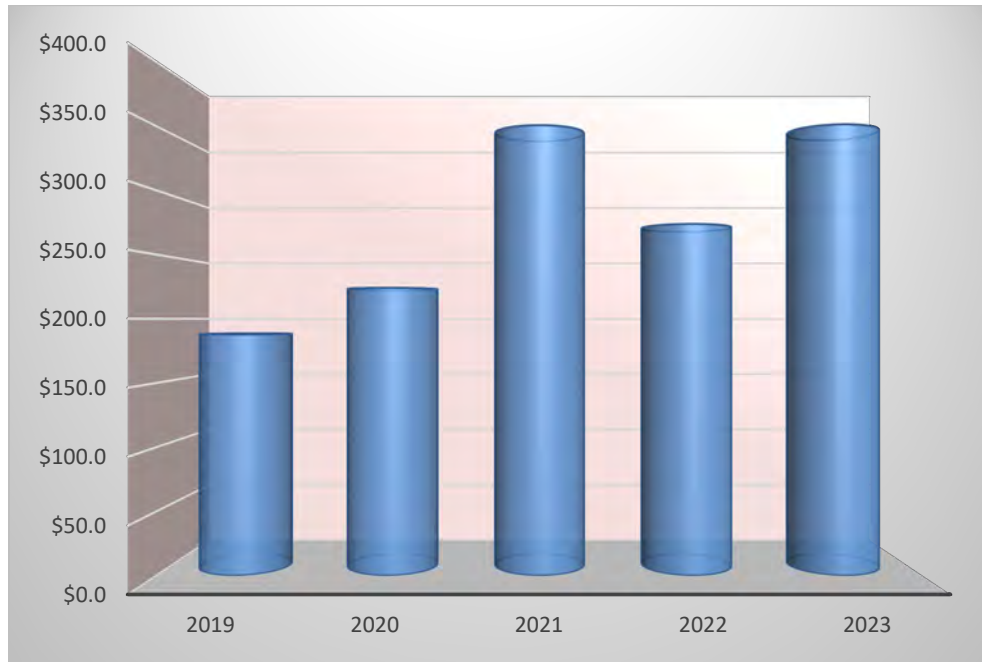

FISCAL YEAR 2023 REVENUE EXPLANATIONS AND PROJECTIONS

LOCAL REVENUE

During the development of the budget, the historical trend of each local revenue item is reviewed. State agencies are contacted during the budget process and the local revenue budget is modified if the agency predictions vary from the historical trend. In FY2023, local revenue contributes approximately **54.52%** of the Cobb County School System’s revenue. The local revenues consist of the following categories:

Property Taxes - The ad valorem tax, more commonly called property tax, is the primary source of revenue for local governments in Georgia. Ad valorem means "according to the value." The County Board of Tax Assessors, which is appointed by the County Board of Commissioners, evaluates and assesses all property for tax purposes. Assessments are based on 40% of the (appraised) market value by law as of the 1st day of January each year. The millage rate is the determining factor in the calculation of taxes (a mill is 1/10 of 1 cent). The State authorities set the millage rate for State taxes, the County Board of Commissioners sets the millage rate for County taxes and the County Board of Education sets the millage rate for County school taxes. The various authorities establish the millage rate by dividing revenue needed by the 40% net assessment. The Tax Commissioner is responsible for collecting taxes based on the set millage rate. The School District pays a 1.6% fee of collections received to the Tax Commissioner for collection of the school taxes.

Property tax bills are mailed on, or about, August 15 each year to the owner on record as of January 1 and payment is due upon receipt. Delinquent taxes are subject to a 5% penalty plus 1% interest per month or any portion thereof, figured on the principal plus the 5% penalty. Fi.Fa tax lien (when a tax liability has gone unpaid and reaches the lien stage), recording fees (\$15.50 on taxes less than \$100 and \$20.50 on taxes \$100 and over) and any administrative levy fees incurred will be charged. The Tax Commissioner collects city taxes for Acworth and Kennesaw. Marietta, Smyrna, Powder Springs and Austell collect their own city taxes. Contact the city Tax Department for information concerning city taxes in these four cities.

Note: **Property Tax Revenue Trends** – Property tax revenue is generated by applying a millage rate to the assessed value in Cobb County each year. Growth in the assessed value of property in Cobb County each year yields additional revenue for the School District. Assessed property growth since FY2012:

Fiscal Year	Property Digest Growth
FY2023	11.55%
FY2022	5.73%
FY2021	4.85%
FY2020	5.44%
FY2019	8.21%
FY2018	6.48%
FY2017	6.00%
FY2016	3.22%
FY2015	4.29%
FY2014	(1.28%)
FY2013	(2.42%)
FY2012	(5.66%)

FISCAL YEAR 2023 REVENUE EXPLANATIONS AND PROJECTIONS (Continued)

Taxes levied on real and personal property are based on values assessed as of January 1. Based on a millage levy of 18.90 mills, a homeowner would pay \$18.9 per \$1,000 on 40% of the assessed value. Taxes not paid in sixty (60) days become delinquent taxes and penalties and interest are assessed.

How your School Taxes are calculated

The following is an example of how FY2023 Cobb County School Taxes are calculated for a \$325,000 home:

<u>M & O Millage</u>	<u>Item</u>
\$325,000	House assessed at Fair Market Value
<u> X .40</u>	40% Assessment Rate
\$130,000	Assessed Value for Tax Purposes
<u>(\$10,000)</u>	Homestead Exemption
\$120,000	Tax Base for Property Tax
<u> X .0189</u>	Millage Rate 18.90
\$ 2,268	M & O School Taxes
	<i>Note: Median Home Value in Cobb County \$325,000, per community survey</i>

Property Tax Exemptions -A property tax exemption excludes all or part of a property's value from property taxation, ultimately resulting in lower property taxes. In Cobb County the Tax Commissioner's office processes the exemption applications. Following are some major exemptions:

Cobb County Basic Homestead - These exemptions apply only to homestead property. For all exemptions, the amount exempted is deducted from the 40% assessed value of the property in the applicable tax categories. Homeowners who meet the basic Homestead Exemption requirements are entitled to a \$10,000 exemption in the county general and school general tax categories. The Basic Homestead Exemption was worth \$273.60 in 2020.

Cobb County School Tax (Age 62) - Homeowners who are 62 years of age on or before January 1 are entitled to an exemption from all taxes in the school general and school bond tax categories.

State Senior Age 65 - Homeowners who are 65 years of age on or before January 1 are entitled to a full exemption in the state tax categories up to 10 contiguous acres immediately surrounding the residence.

State Senior Age 65 \$4,000 (\$10,000 Income Limit) - Homeowners who are 65 years of age on or before January 1 and whose annual NET income does not exceed \$10,000 for the immediately preceding tax year (including income of the spouse but not including Social Security or retirement income) are entitled to a \$4,000 exemption in the state, county bond and fire district tax categories.

Cobb County \$22,000 Disability - Homeowners who are disabled on or before January 1, and whose annual NET income (including income of the spouse, but not including income received as a result of the disability; e.g. disability retirement) does not exceed \$12,000 for the immediately preceding year are entitled to a \$22,000 exemption in all tax categories except the state.

FISCAL YEAR 2023 REVENUE EXPLANATIONS AND PROJECTIONS (Continued)

State Veteran's Disability - Homeowners who are disabled veterans as defined in O.C.G.A. 48-5-48 are entitled to an exemption in all tax categories.

State Surviving Spouse – A homeowner who is the un-remarried surviving spouse of a member of the U.S. armed forces killed in any war or conflict as defined in O.C.G.A. 48-5-52.1 and receiving spousal benefits from the U. S. Department of Veteran's Affairs is entitled to an exemption in all tax categories.

State Surviving Spouse of a Peace Officer or firefighter killed in the Line of Duty – The un-remarried surviving spouse of a peace officer or firefighter killed in the line of duty is entitled to an exemption for the full value of the homestead.

Real Estate Transfers - A tax imposed on the transfer of real estate located within Cobb County. The tax is \$1.00 on the first \$1,000 or less of the purchase price or value of the property, and \$.10 of each additional \$100 or fraction thereof. Transfers with a purchase price of less than \$100 are not taxable. This tax has a direct relationship of property being bought in the county.

Title Ad Valorem Tax (TAVT) – According to House Bill 386, new TAVT is introduced. Motor vehicles purchased on or after March 1, 2013 and titled in Georgia are exempt from Georgia sales and use tax and annual ad valorem tax, also known as “the birthday tax.” These motor vehicles are instead subject to a one-time State and Local TAVT Fee, as provided by O.G.G.A. 48-5C-1.

Intangible Recording Tax - Holders of “long term” notes secured by real estate pay the Georgia intangible recording tax to the Tax Commissioner. The rate is \$1.50 per \$500 or fraction thereof of the principal amount of the loan. The maximum amount of recording tax on any single note is \$25,000.

Alcoholic Beverages - Tax collected on all alcoholic beverages sold in Cobb County.

Liquor by the Drink - Tax collected on all liquor by the drink sold in Cobb County.

Tuition and Fees - Charged to non-employees enrolled in District professional learning classes.

Interest Income - Interest income are funds collected as interest on all school investments and the interest charged to delinquent taxes.

Other Local Revenue - These funds include revenue from Cell Tower contracts, sale of school assets, revenue from District property leasing or school facility rental, reimbursement revenue from students for school property damages, school gate receipts of sports half time exhibition, and other miscellaneous revenue (examples include copies, ID badges, transcripts, etc.).



FISCAL YEAR 2023 REVENUE EXPLANATIONS AND PROJECTIONS (Continued)

STATE REVENUE

State revenue is earned via a formula entitled the Quality Basic Education (QBE) Act which is approved by the State of Georgia legislature. The main criteria for State funding is student growth. In FY2023, the State contributes approximately **44.81%** of the Cobb County School System’s revenue.

QBE Funding Formula Summary

1. **Full-Time Equivalent** - The funding formula utilizes a concept called Full-Time Equivalent (FTE). The State of Georgia allocates funds to school districts based on their number of full-time students. Cobb County reports enrollment during each school year to the State of Georgia. Each school day is divided into six parts and the student is counted six times. Students in the following programs or situations may not be counted for the portion of the day that they are in them:

- Study Hall
- Students on Minimum Day Schedule
- Non-credit Courses

EXAMPLE: A student taking the following in school is counted as 5/6 FTE instead of 1 FTE:

<u>Item</u>	<u># Items</u>	<u>FTE</u>
Math	1	1
English	1	1
Social Studies	1	1
Science	1	1
Study Hall	1	0
Literature	<u>1</u>	<u>1</u>
Total	6	5

2. **Program Weights** - Since different programs (kindergarten, primary grades 1-3, middle school grades 6-8, etc) vary in their cost of operation, each program is assigned a program weight. The Governor is authorized to appoint a task force every three years to recommend to the General Assembly any needed changes in the program weights. The following are the FY2023 Program Weights:

<u>Programs</u>	<u>Weights</u>	<u>Programs</u>	<u>Weights</u>
Kindergarten	1.6773	Remedial	1.3609
Kindergarten EIP	2.0753	Alternative	1.4921
Grades 1-3	1.2970	Special Ed Cat I	2.4194
Grades 1-3 EIP	1.8237	Special Ed Cat II	2.8524
Grades 4-5	1.0397	Special Ed Cat III	3.6352
Grades 4-5 EIP	1.8184	Special Ed Cat IV	5.8994
Grades 6-8	1.0325	Special Ed Cat V	2.4793
Middle School	1.1396	Gifted	1.6843
Grades 9-12	1.0000	ESOL Program	2.6007
Vocational Lab	1.1811		

3. **Training & Experience** - The State of Georgia allocates additional funds to school districts to adjust for varying levels of teacher education and years of experience.

FISCAL YEAR 2023 REVENUE EXPLANATIONS AND PROJECTIONS (Continued)

4. **Local Five Mill Share** - The Local Share for each local system is an amount of money equal to the amount that can be raised by levying five (5) mills on the forty (40) percent equalized property tax digest. Each local system will receive an amount of State funds that is the QBE program cost for the system MINUS the Local Share Amount. Cobb County's Local Share contribution in FY2023 is \$184.3 million.

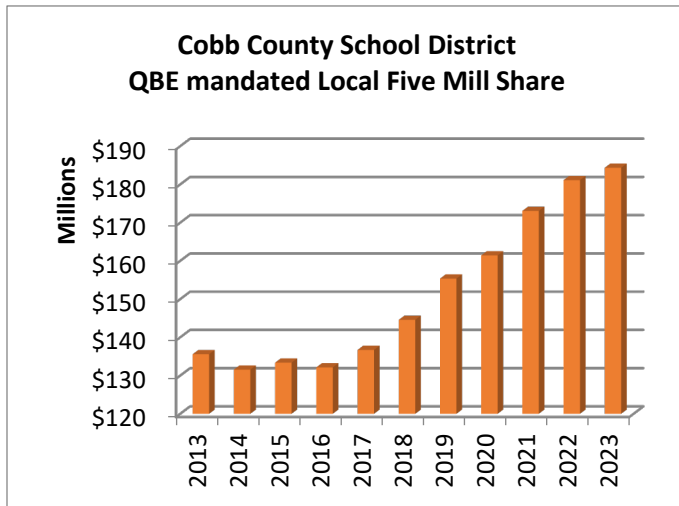

<u>YEAR</u>	<u>LOCAL SHARE</u>
2013	\$135,582,243
2014	\$131,545,626
2015	\$133,378,961
2016	\$132,140,111
2017	\$136,707,956
2018	\$144,570,520
2019	\$155,355,360
2020	\$161,428,591
2021	\$173,065,651
2022	\$181,102,559
2023	\$184,350,943

These amounts are deducted from the State revenue earned by Cobb County

5. **Base Amount** - Standard Cost per Student amount established by the State of Georgia. The base amount for FY2023 is \$2,897.28 per student.

QBE Formula

To determine the total State funds for a specific school system, the following formula is used:

FTE Count X Program Weight X Base Amount X Training & Experience Factor - Five Mill Share



FISCAL YEAR 2023 REVENUE EXPLANATIONS AND PROJECTIONS (Continued)

FEDERAL REVENUE

The Cobb County School District receives a small portion of its revenue from the Federal Government. In FY2023, projected federal revenue is approximately **0.67%** of the Cobb County School System's revenue. The following is a listing of the various Federal Revenue sources:

Indirect Cost Revenue – Reimbursement allowed under selected federal grant programs to help compensate the School District for administrative costs and overhead costs that support the grant.

ROTC Revenue – The Federal Government pays half of the cost of ROTC instructors.

MedACE Revenue – The Administrative Claiming Education (ACE) program is a Medicaid program administered through the Children's Intervention School Services Office in conjunction with the Georgia Department of Community Health. This program allows the District to be reimbursed under the Federal Medicaid program for portions of administrative costs associated with providing school-based health services.

Medicaid Reimbursement – This program reimburses the District for certain medical services provided to a child under his/her Individual Education Program (IEP). This program is only available to Medicaid-eligible students. This program allows the District an opportunity to obtain funding which would otherwise be unavailable to the District, thereby strengthening the District's ability to deliver high quality education to the student.



MAJOR CATEGORIES OF GENERAL FUND BUDGET

Major General Fund Revenue Balancing Items

Revenue Type	FY2023 Original Budget	Comments:
LOCAL REVENUE	\$710,604,797	
Property Tax Revenue	\$629,045,845	10.49% Projected Digest increase; 98% Collection Rate; 1.6% Cobb Collection Fee
Property Tag Revenue (Ad Valorem & TAVT)	\$44,879,890	Property tax collected for registering and titling motor vehicles
Delinquent Tax Revenue	\$2,577,014	Reflects collection rate from the most recently completed fiscal year
Intangible Tax Revenue	\$19,752,286	Reflects collection rate from the most recently completed fiscal year
Real Estate Transfer Revenue	\$6,182,138	Reflects collection rate from the most recently completed fiscal year
Alcoholic Beverage Revenue	\$1,905,425	Reflects collection rate from the most recently completed fiscal year
Liquor by the Drink	\$1,287,706	Reflects collection rate from the most recently completed fiscal year
Interest on Delinquent Taxes	\$459,320	Reflects collection rate from the most recently completed fiscal year
Interest Income	\$304,022	Reflects an analysis of interest rates applied to average monthly balances
Local Revenue – Cell Tower	\$1,642,164	Budget based on cell tower agreements
Local Revenue – Other	\$1,859,860	Reflects collection rate from the most recently completed fiscal year
Sale of Assets	\$251,127	Estimated revenue from sale of school district assets
Warehouse Lease Revenue	\$43,000	Lease revenue on school district property
Transfer from Other Funds	\$415,000	Budget based on projected actual
STATE REVENUE	\$584,111,998	
State QBE Revenue	\$578,512,537	Quality Basic Education (QBE) revenue received from the State of Georgia based on student Full Time Equivalents (FTE) counts
Miscellaneous State Grants	\$5,599,461	Revenue received from miscellaneous State Grants

MAJOR CATEGORIES OF GENERAL FUND BUDGET (Continued)

Major General Fund Revenue Balancing Items

FEDERAL REVENUE	\$8,692,647	
Indirect Cost Revenue	\$5,606,481	Revenue estimate for Indirect Cost revenue – reimbursement of overhead costs involved in operating various school district programs
ROTC Instructor Reimbursement	\$1,239,971	Estimated revenue reimbursement from the Federal Government for ROTC instructor salaries
MedACE Revenue	\$1,138,479	Estimated revenue for reimbursement for costs incurred for providing school-based health services
Medicaid Revenue	\$707,716	Estimated revenue for reimbursement for costs incurred for Medicaid eligible students through the IEP (Individualized Education Program)
TOTAL REVENUE	\$1,303,409,442	

Major General Fund Expenditure Balancing Items

Expenditure Type	FY2023 Original Budget	Comments:
FY2022 Original Budget	\$1,235,857,199	Original Budget for FY2022
FY2023 Expenditure Changes:		
FY2022 General Fund Expenditure Budget Adjustments	\$19,891,226	Purchase of School Buses with Bus Bond Funding \$926,640; and Encumbrances \$18,964,586
FY2022 One-Time Expenditures	(\$20,515,226)	SPLOST 6 Election Expenditures (\$624,000); Purchase of School Buses with Bus Bond Funding (\$926,640); and Encumbrances (\$18,964,586)

MAJOR CATEGORIES OF GENERAL FUND BUDGET (Continued)

Major General Fund Expenditure Balancing Items

Salary/Benefit Changes	\$16,175,450	\$14,864,884 Full Salary Step for All Eligible Employees; \$1,310,566 Increase in Employer TRS (from 19.81% to 19.98%)
Salary/Position Adjustments	(\$6,949,179)	\$2,191,660 position for Enrollment; \$5,200,000 for 50 Additional Instructional Allotment; (\$18,876,950) Reduce Instructional Vacancies for Prior Year; \$469,560 Library Media Parapro; \$782,606 Upgrade ES Clerks; \$1,254,350 Add 10 School Psychologists; \$135,632 Nurse Planning; \$265,000 Custodians for Additional Square Footage; \$1,628,963 for Other Position Additions and Adjustments
Miscellaneous Expenditure Adjustments	\$2,017,971	Miscellaneous Expenditure Adjustments for Cell Tower (\$179,473); Operation and safety Adjustment \$1,619,725; Utility Expenditure Adjustment \$1,522,116; MedAce Adjustment \$21,338; Medicaid Adjustment \$18,171; Miscellaneous State Grants, (\$608,659), Nes School Opening Procedure Adjustment (\$375,247), etc.
TOTAL EXPENDITURES	\$1,333,260,529	

BUDGET SUMMARY	FY2023 BUDGET
Budgeted Revenue	\$1,303,409,442
Budgeted Recurring Expenditures	\$(1,333,260,529)
Utilize Funds Reserved from Prior Year	\$29,851,087
Total Balanced Budget	\$0

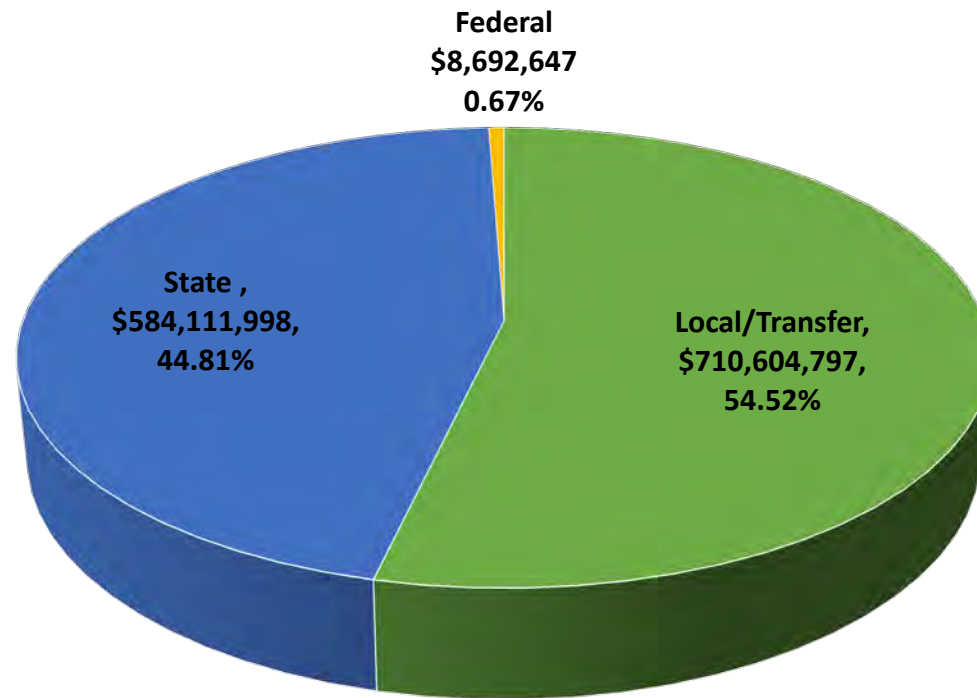

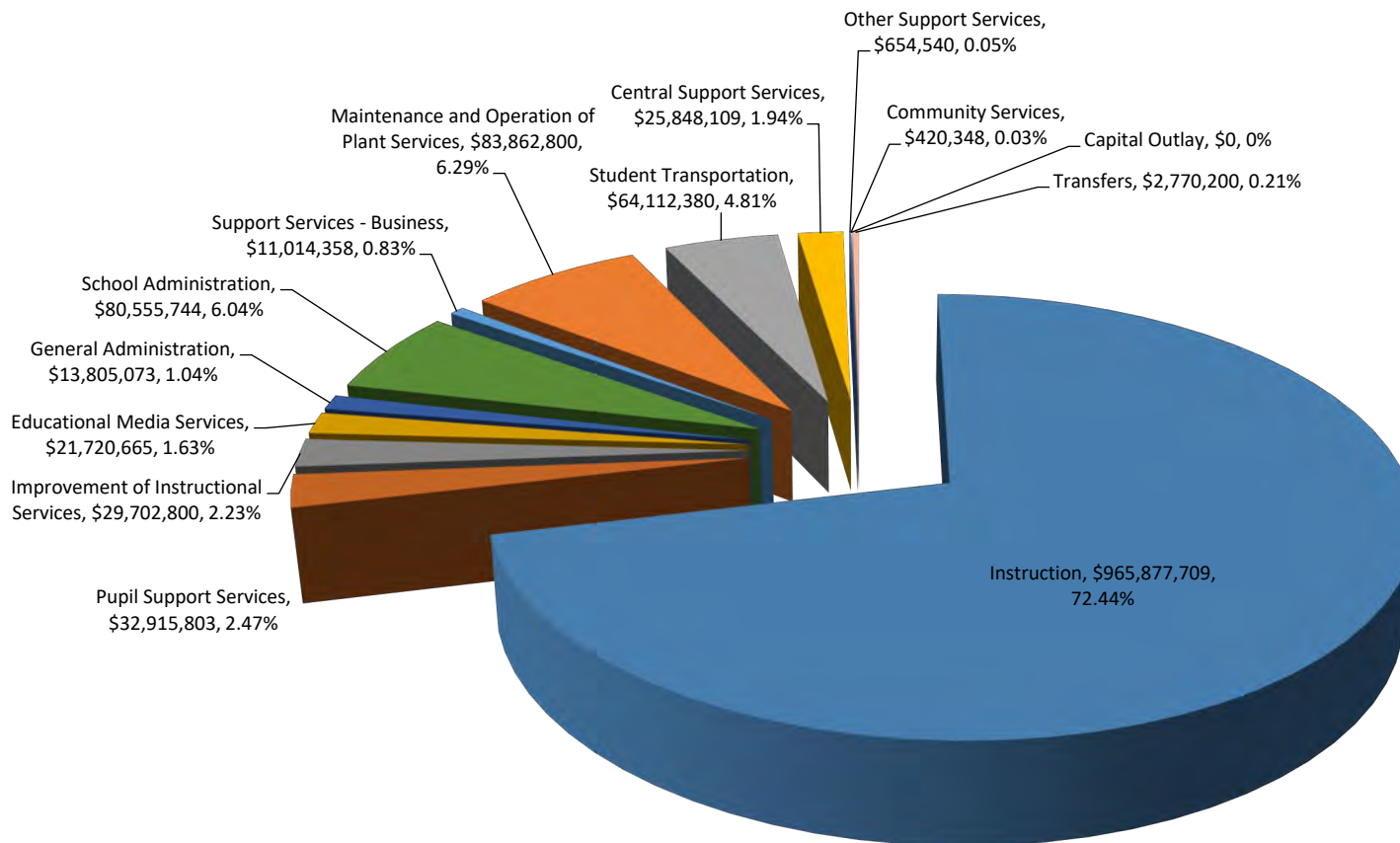

TOTAL GENERAL FUND EXPENDITURES \$1,333,260,529

**GENERAL FUND BUDGET
BOND DEBT AND LONG-TERM OBLIGATION**

Long-Term Bond Debt

As of January 31, 2007, the Cobb County School District is free from all long-term debt. The Board voted to eliminate the debt service millage rate of 0.90 mills as part of the FY2008 budget. The additional millage tax rate has not been needed while there has been no long-term debt.

Long-Term Obligation

Accrued Vacation Pay

The Cobb County School District employees who work an annual employment year are eligible to earn vacation leave. An employee’s vacation leave accrual rate is determined by a combination of his/her years of employment in both education and the District.

An employee may accumulate up to four (4) times the amount of vacation leave he/she earns annually. An employee who resigns, retires, or changes from annual employment to less-than-annual employment status will be reimbursed for accumulated vacation leave at the rate of the annual salary for each day of vacation accumulated up to the maximum described above (District [Policy GARK-R](#) Vacations). Accrued vacation pay is generally liquidated by the General Fund.

Fiscal year 2022 **long-term obligations** are as follows:

	Balance			Amounts		
	6/30/2021	Increase	Decrease	Balance 6/30/2022	Due Within One Year	Amounts Due After One Year
Accrued						
Vacation Pay	14,842,000	9,897,000	9,534,000	15,205,000	9,767,000	5,438,000
Net OPEB Liab	909,504,000	10,670,000	242,296,000	677,878,000	-	677,878,000
Net Pension Liab	1,350,882,000	90,105,000	943,133,000	497,854,000	-	497,854,000
Total LT Debt	\$2,275,228,000	\$110,672,000	\$1,194,963,000	\$1,190,937,000	\$9,767,000	1,181,170,000

Accrued vacation pay, pension, and OPEB obligations are largely liquidated by the General Fund.



GENERAL FUND BUDGET
BOND DEBT AND LONG-TERM OBLIGATION (Continued)

Other Post Employment Benefits (OPEB)

Plan Description

The District participates in the State of Georgia School Employees Postemployment Benefit Fund (the School OPEB Fund) which is another postemployment benefit (OPEB) plan administered by the State of Georgia Department of Community Health (DCH). Certified teachers and non-certified employees of the District as defined in §20-2-875 of the *Official Code of Georgia Annotated* (O.C.G.A.) are provided OPEB through the School OPEB Fund - a cost-sharing multiple-employer defined benefit postemployment healthcare plan, reported as an employee trust fund of the State of Georgia and administered by a Board of Community Health (DCH Board). Title 20 of the *O.C.G.A.* assigns the authority to establish and amend the benefit terms of the group health plan to the DCH Board. The School OPEB Fund is included in the State of Georgia Comprehensive Annual Financial Report which is publicly available and can be obtained at <https://sao.georgia.gov/comprehensive-annual-financialreports>.

Benefits

The School OPEB Fund provides healthcare benefits for retirees and their dependents due under the group health plan for public school teachers, including librarians, other certified employees of public schools, regional educational service agencies, and non-certified public school employees. Retiree medical eligibility is attained when an employee retires and is immediately eligible to draw a retirement annuity from Employees' Retirement System (ERS), Georgia Judicial Retirement System (JRS), Legislative Retirement System (LRS), Teachers Retirement System (TRS) or Public School Employees Retirement System (PSERS). If elected, dependent coverage starts on the same day as retiree coverage. Medicare-eligible retirees are offered Standard and Premium Medicare Advantage plan options. Non-Medicare eligible retiree plan options include Health Reimbursement Arrangement (HRA), Health Maintenance Organization (HMO) and a High Deductible Health Plan (HDHP). The School OPEB Fund also pays for administrative expenses of the fund. By law, no other use of the assets of the School OPEB Fund is permitted.

Contributions

As established by the Board of Community Health, the School OPEB Fund is substantially funded on a pay-as-you-go basis; that is, annual cost of providing benefits will be financed in the same year as claims occur. Contributions required and made to the School OPEB Fund from the District were \$22,319,063 for the year ended June 30, 2022. Active employees are not required to contribute to the School OPEB Fund.

OPEB Liabilities, OPEB Expense, and Deferred Outflows of Resources and Deferred Inflows of Resources Related to OPEB

At June 30, 2022, the District reported a liability of \$677,877,868 for its proportionate share of the net OPEB liability. The net OPEB liability was measured as of June 30, 2021. The total OPEB liability used to calculate the net OPEB liability was based on an actuarial valuation as of June 30, 2020. An expected total OPEB liability as of June 30, 2021 was determined using standard roll-forward techniques. The District's proportion of the net OPEB liability was actuarially determined based on employer contributions to the School

**GENERAL FUND BUDGET
BOND DEBT AND LONG-TERM OBLIGATION (Continued)**

OPEB Fund during the fiscal year ended June 30, 2021. At June 30, 2021, the District's proportion was 6.258782%, which was an increase of 0.066484% from its proportion measured as of June 30, 2020.

For the year ended June 30, 2022, the District recognized OPEB revenue of \$4,680,310. At June 30, 2022, the District reported deferred outflows of resources and deferred inflows of resources related to OPEB from the following sources:

	Deferred Outflows of Resources	Deferred Inflows of Resources
Differences between expected and actual experience	\$0	\$ 309,516,882
Changes of Assumptions	124,129,897	55,314,404
Net difference between projected and actual earnings on OPEB plan investments	0	1,074,900
Changes in proportion and differences between District contributions and proportionate share of contributions	11,933,671	7,698,281
District contributions subsequent to the measurement date	22,319,063	0
Total	\$158,382,631	\$373,604,467

Special Revenue Funds

SPECIAL REVENUE FUNDS BUDGET

Special Revenue Funds are used to account for proceeds of specific revenues from federal, state and local sources that are legally restricted to expenditures for specified purposes. These funds also account for receipt and expenditure of resources transferred from the General Fund where revenues are inadequate to finance the specified activities.



**SPECIAL REVENUE FUND BUDGET
REVENUE AND APPROPRIATIONS (FUNCTION)
EIGHT YEAR COMPARISON**

	FY2019	FY2020	FY2021	FY2022	FY2023	FY2024	FY2025	FY2026
Description	Actual	Actual	Actual	Revised Budget	Approved Budget	Forecast	Forecast	Forecast
Beginning Fund Balance July 1 (Estimated)	\$26,947,320	\$26,654,023	\$17,118,848	\$12,724,402	\$38,424,786	\$33,910,619	\$29,396,452	\$24,882,285
Revenue:								
Local	\$33,665,422	\$28,112,115	\$5,931,684	\$15,121,521	\$35,395,025	\$35,395,025	\$35,395,025	\$35,395,025
State	\$6,524,199	\$6,482,269	\$5,646,276	\$5,941,873	\$5,792,766	\$5,792,766	\$5,792,766	\$5,792,766
Federal	\$82,202,640	\$76,692,493	\$203,095,506	\$292,330,283	\$88,560,626	\$88,560,626	\$88,560,626	\$88,560,626
Transfers/Other	\$1,443,910	\$1,615,122	\$7,292,091	\$1,988,240	\$1,770,200	\$1,770,200	\$1,770,200	\$1,770,200
Total Revenue	\$123,836,171	\$112,901,999	\$221,965,557	\$315,381,917	\$131,518,617	\$131,518,617	\$131,518,617	\$131,518,617
Total Revenue & Fund Balance	\$150,783,491	\$139,556,023	\$239,084,405	\$328,106,319	\$169,943,403	\$165,429,236	\$160,915,069	\$156,400,902
Appropriations								
Instruction	\$25,050,317	\$28,173,769	\$133,332,793	\$163,220,257	\$28,481,078	\$28,481,078	\$28,481,078	\$28,481,078
Pupil Support Services	\$8,451,439	\$5,609,322	\$5,130,027	\$8,909,010	\$5,594,463	\$5,594,463	\$5,594,463	\$5,594,463
Improvement of Instr Svcs	\$7,419,197	\$8,214,934	\$8,756,254	\$15,717,833	\$9,140,005	\$9,140,005	\$9,140,005	\$9,140,005
Educational Media Services	\$0	\$0	\$215,571	\$7,748	\$7,748	\$7,748	\$7,748	\$7,748
Instructional Staff Training	\$10,970,947	\$10,394,747	\$10,005,378	\$15,172,658	\$11,808,290	\$11,808,290	\$11,808,290	\$11,808,290
Federal Grant Administration	\$822,828	\$835,343	\$820,325	\$1,036,215	\$977,748	\$977,748	\$977,748	\$977,748
General Administration	\$1,803,601	\$2,151,140	\$2,125,112	\$16,499,775	\$1,841,370	\$1,841,370	\$1,841,370	\$1,841,370
School Administration	\$163,144	\$184,349	\$1,173,538	\$598,110	\$24,545	\$24,545	\$24,545	\$24,545
Support Services-Business	\$18,725	\$33,273	\$86,225	\$436,041	\$28,173	\$28,173	\$28,173	\$28,173
Maint. & Oper of Plant Svcs	\$1,655,994	\$2,110,898	\$2,782,378	\$3,455,443	\$2,009,027	\$2,009,027	\$2,009,027	\$2,009,027
Student Transportation	\$1,570,246	\$1,898,619	\$3,060,159	\$5,234,863	\$1,746,936	\$1,746,936	\$1,746,936	\$1,746,936
Support Services - Central	\$321,511	\$389,143	\$7,595,375	\$1,019,026	\$163,749	\$163,749	\$163,749	\$163,749
Other Support Services	\$33,526	\$78,781	\$872,833	\$75,462	\$20,693	\$20,693	\$20,693	\$20,693
School Nutrition Program	\$56,598,368	\$54,779,487	\$45,156,431	\$72,235,833	\$63,042,378	\$63,042,378	\$63,042,378	\$63,042,378
Enterprise Operations	\$0	\$0	\$0	\$0	\$0	\$0	\$0	\$0
Community Services	\$9,038,570	\$7,460,488	\$4,104,722	\$8,503,735	\$11,146,581	\$11,146,581	\$11,146,581	\$11,146,581
Capital Outlay	\$88,173	\$0	\$0	\$2,189,690	\$0	\$0	\$0	\$0
Transfers	\$122,881	\$122,881	\$1,142,881	\$0	\$0	\$0	\$0	\$0
Debt Service	\$0	\$0	\$0	\$0	\$0	\$0	\$0	\$0
Total Appropriations	\$124,129,468	\$122,437,174	\$226,360,003	\$314,311,699	\$136,032,784	\$136,032,784	\$136,032,784	\$136,032,784
Ending Fund Balance June 30 (Estimated)	\$26,654,023	\$17,118,848	\$12,724,402	\$13,794,620	\$33,910,619	\$29,396,452	\$24,882,285	\$20,368,118
Total Expenditures & Fund Balance	\$150,783,491	\$139,556,023	\$239,084,405	\$328,106,319	\$169,943,403	\$165,429,236	\$160,915,069	\$156,400,902

Note: FY2021 received Federal CARES Act relief fund \$110M, ARPA Fund \$6M for COVID-19. FY2022 received ARPA fund \$71M.

Note: The Special Revenue FY2023 Fund balance raise is mainly impacted by the increased Federal School Nutrition funding support.

Note: The grant fund budget of FY2024, FY2025, FY2026 are projected with FY2023 amounts.

**SPECIAL REVENUE FUND BUDGET
REVENUE AND APPROPRIATIONS (OBJECT)
EIGHT YEAR COMPARISON**

Description	FY2019 Actual	FY2020 Actual	FY2021 Actual	FY2022 Revised Budget	FY2023 Approved Budget	FY2024 Forecast	FY2025 Forecast	FY2026 Forecast
Beginning Fund Balance July 1 (Estimated)	\$26,947,320	\$26,654,023	\$17,118,848	\$12,724,402	\$38,424,786	\$33,910,619	\$29,396,452	\$24,882,285
Revenue:								
Local	\$33,665,422	\$28,112,115	\$5,931,684	\$15,121,521	\$35,395,025	\$35,395,025	\$35,395,025	\$35,395,025
State	\$6,524,199	\$6,482,269	\$5,646,276	\$5,941,873	\$5,792,766	\$5,792,766	\$5,792,766	\$5,792,766
Federal	\$82,202,640	\$76,692,493	\$203,095,506	\$292,330,283	\$88,560,626	\$88,560,626	\$88,560,626	\$88,560,626
Transfers/Other	\$1,443,910	\$1,615,122	\$7,292,091	\$1,988,240	\$1,770,200	\$1,770,200	\$1,770,200	\$1,770,200
Total Revenue	\$123,836,171	\$112,901,999	\$221,965,557	\$315,381,917	\$131,518,617	\$131,518,617	\$131,518,617	\$131,518,617
Total Revenue & Fund Balance	\$150,783,491	\$139,556,023	\$239,084,405	\$328,106,319	\$169,943,403	\$165,429,236	\$160,915,069	\$156,400,902
Appropriations								
51 Salaries	\$58,600,167	\$60,948,449	\$133,986,874	\$133,786,571	\$57,264,139	\$57,264,139	\$57,264,139	\$57,264,139
52 Employee Benefits	\$23,384,063	\$25,859,839	\$50,117,575	\$47,497,437	\$24,654,009	\$24,654,009	\$24,654,009	\$24,654,009
53 Contract Services	\$1,885,367	\$1,762,131	\$2,061,967	\$16,122,171	\$2,019,533	\$2,019,533	\$2,019,533	\$2,019,533
54 Repair and Rental w Water	\$496,165	\$433,236	\$240,940	\$297,592	\$387,523	\$387,523	\$387,523	\$387,523
55 Other Purchases w Telephone	\$3,680,152	\$3,502,260	\$4,398,288	\$9,170,743	\$3,613,850	\$3,613,850	\$3,613,850	\$3,613,850
56 Supplies and Equipments w Utilities	\$29,056,082	\$23,660,921	\$30,979,270	\$48,295,142	\$39,912,484	\$39,912,484	\$39,912,484	\$39,912,484
58 Dues and Other Fees	\$4,555,662	\$5,062,258	\$2,631,519	\$17,924,864	\$6,965,407	\$6,965,407	\$6,965,407	\$6,965,407
59 Transfers	\$122,881	\$122,881	\$1,142,881	\$0	\$415,000	\$415,000	\$415,000	\$415,000
66 Fixed Assets Equipt	\$336,616	\$219,254	\$406,659	\$39,843,441	\$349,061	\$349,061	\$349,061	\$349,061
67 Fixed Assets CIP w Bldgs/Land	\$1,824,864	\$125,616	\$1,947	\$0	\$0	\$0	\$0	\$0
68 Other	\$187,449	\$740,330	\$392,083	\$1,373,738	\$451,778	\$451,778	\$451,778	\$451,778
Total Appropriations	\$124,129,468	\$122,437,174	\$226,360,003	\$314,311,699	\$136,032,784	\$136,032,784	\$136,032,784	\$136,032,784
Ending Fund Balance June 30 (Estimated)	\$26,654,023	\$17,118,848	\$12,724,402	\$13,794,620	\$33,910,619	\$29,396,452	\$24,882,285	\$20,368,118
Total Expenditures & Fund Balance	\$150,783,491	\$139,556,023	\$239,084,405	\$328,106,319	\$169,943,403	\$165,429,236	\$160,915,069	\$156,400,902

Note: FY2021 received Federal CARES Act relief fund \$110M, ARPA Fund \$6M for COVID-19. FY2022 received ARPA fund \$71M.

Note: The Special Revenue FY2023 Fund balance raise is mainly impacted by the increased Federal School Nutrition funding support.

Note: The grant fund budget of FY2024, FY2025, FY2026 are projected with FY2023 amounts.

**SPECIAL REVENUE FUNDS
FIVE YEAR TREND OF FUND BALANCE**

\$ Millions

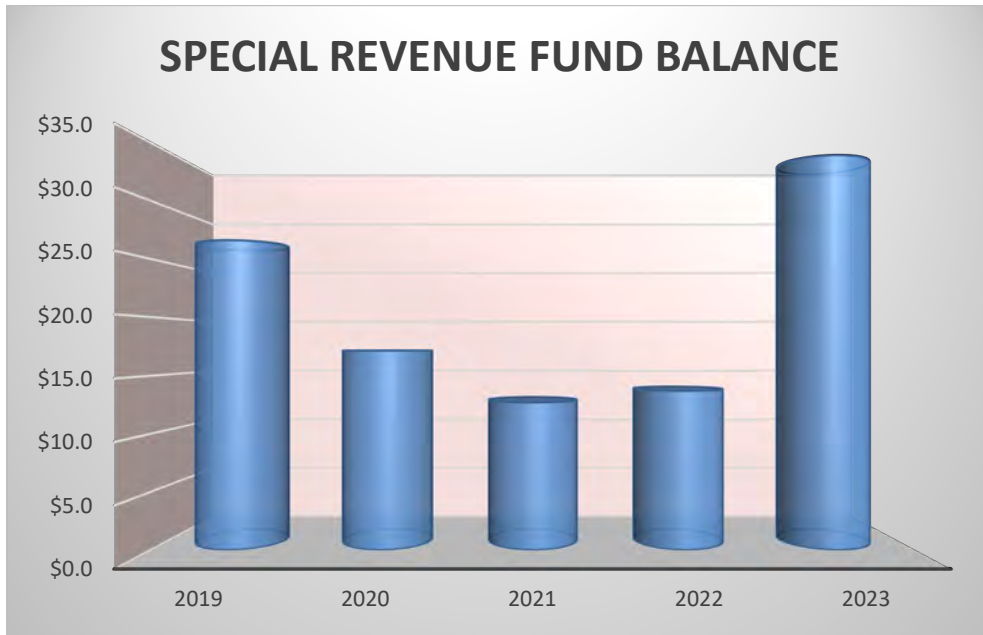

SPECIAL REVENUE FUNDS
SPECIAL REVENUE SOURCES AND FUND DESCRIPTIONS

Special Revenue Funds (Special Fee Based Programs)

The Cobb County School District has multiple Special Revenue funds that depend on fees in order to fund and operate the program. Each year during the budget process, each of these programs is examined to anticipate program participation. Based on this examination, revenue is estimated. The scope of each program is then adjusted based on available resources.

Special Revenue Grants (Federal and State)

Special Revenue Grant revenue is projected based on previous year grant awards. Each grant is adjusted in the current year before funds are spent based on the actual grant award for that year.

SPECIAL PROGRAMS

FUND #	FUND NAME	FUND DESCRIPTION
549	Donations	Funds donated to the school system for specific purposes by individuals or corporation
550	Venue Management	Venue Management (formerly Facility Use) program organizes the rental of school facilities during non-instructional hours, to provide the community with a place to hold activities at a nominal fee.
551	After School Program	The After School Program utilizes designated school facilities to provide supervision to children in elementary schools from school release time until 6:00 p.m. The revenues have been committed by the Board for use by local principals to benefit students and faculty subject to District policy.
552	Performing Arts Program	This program offers an opportunity for students in kindergarten through eighth grade to experience professional quality performances of music, drama & dance. It is funded by voluntary student contributions
553	Tuition School Program	This fund provides the opportunity for students to make up school classes and provide enrichment and remedial work at various instructional levels
554	Public Safety	This program is funded by parking decals sold to students which are used to pay for campus police officers
556	Adult High School	Adult High School provides the opportunity for students 16 years of age and older, who are not enrolled in a regular high school, to improve their basic educational skills and work towards high school completion
557	Art Career and Cultural Exploration	This fund provides local artist compensation for workshops held in the schools
580	Miscellaneous Grants	This fund provides funding from a compilation of several State grants which are awarded for educational purposes.

**SPECIAL REVENUE FUNDS
FUND DESCRIPTIONS (Continued)**

STATE AID

FUND #	FUND NAME	FUND DESCRIPTION
510	Adult Education	The grant funds via the Georgia Department of Technical and Adult Education which are used to educate adults. The program is a part of the national effort to ensure that all adults are literate and able to compete in the global economy
532	GNETS	This program provides students identified as severely emotionally behavior disordered, or autistic, with appropriate education
560	Pre-Kindergarten Lottery	This program is funded by the Georgia lottery coordinates and provides services to eligible four-year old children and their families for 180 instructional days

FEDERAL AID

FUND #	FUND NAME	FUND DESCRIPTION
402	Title I	The program provides funding on specified remedial education for children in identified economically disadvantaged elementary and middle school attendance areas, to ensure that all children, particularly those who are most academically at-risk, meet challenging state academic standards.
404	IDEA	The grant provides direct and related support services for handicapped children
406	Vocational Education	The grant provides career training and opportunities to students
414	Title II	The grant provides funds to advance teacher quality through professional learning, preparation, recruitment and retention as well as upgrading teachers' skills in science and mathematics areas
420	CARES Act Relief Fund	Provides grant education funding for Elementary and Secondary School Emergency Relief to help with response to COVID-19
432	Homeless Grant	The grant provides educational services for homeless children
448	American Rescue Plan (ARP) Act	Provides education funding for Elementary and Secondary School Secondary Emergency Relief to help with response to COVID-19
460	Title III	The program provides support to Limited English Proficiency (LEP) students, and their families, through language instructional programs
462	Title IV	Programs include 21 st Century Classroom, Success For All Students, the Mentoring Program, Safe & Drug Free and Reduce Alcohol Abuse
478	USDA Fruit & Vegetables	This is a program during the school day to provide a nutritious snack that helps students stay focused on learning
600	School Nutrition	The fund provides breakfast and lunch to students during the school day

SPECIAL REVENUE FUNDS AMERICAN RESCUE PLAN (ARP) ACT

The American Rescue Plan (ARP) Act was approved by the U.S. House of Representatives and the U.S. Senate in March of 2021. ARP will provide dedicated K-12 education COVID-19 relief and recovery assistance of approximately **\$4.3 billion** to Georgia, with **\$3.8 billion** distributed directly to Local Education Agencies. Funds have been earmarked for the following purposes:

- *Safely returning to in-person instruction*
- *Addressing learning loss for students most impacted by the pandemic*
- *Promoting safe and healthy learning environments*
- *Re-engaging students who have been chronically absent during the pandemic or who have had significant adverse experiences*
- *Assisting educators in providing virtual or hybrid instruction (including supporting use of educational technology)*
- *Supporting emotional well-being for all school personnel*
- *Ensuring continuity of core services including, but not limited to, restoring potential budget reductions, school meals, facilities & equipment, etc.*

Funding Impact to Cobb County Schools

The CCSD has been allocated \$160,600,790 in ARP funds. The U.S. Department of Education has given states 65 percent of these funds up front. The remaining 35 percent of funds will be applied for by the Georgia Department of Education. The CCSD portion of up-front funding is \$104,390,514; the remaining \$56,210,276 will be received in the coming months. As with all funding granted, CCSD will seek to maximize the use of ARP funds for instruction of students and distribute all funds in an equitable manner.

Safe Return to In-Person Instruction

We understand our community’s concerns regarding the potential impact of COVID-19 and want to keep our school families updated on how Cobb Schools is responding. We also want our school community to have access to the most updated and reliable information. Health and safety protocols regarding COVID-19 can be found on the District’s website records.

Addressing Learning Loss

The ARP Act requires at least 20 percent of the funds be used to address the academic impact of all students lost instructional time. Any of the implemented programs should be evidence-based interventions. Cobb’s plan is to implement interventions through the Summer Quest program, as well as extended day, after school programs and student credit recovery opportunities. These programs are available to all CCSD students who have been impacted by the pandemic.

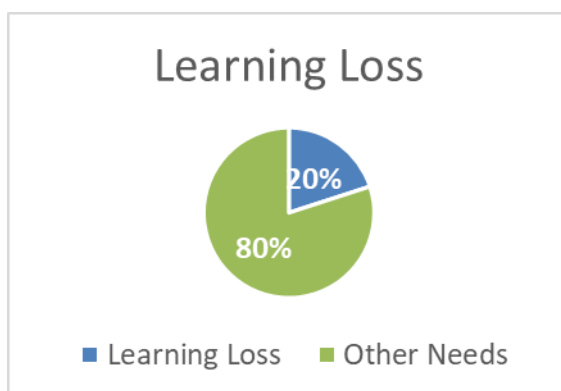

SPECIAL REVENUE FUNDS
SUMMARY OF SPECIAL REVENUE FUNDS
FY2023 BUDGET

Description	Special Program	State Aid	Federal Aid	Total
Beginning Fund Balance (Estimate)				
July 1, 2022	\$8,154,906	\$189,306	\$30,080,574	\$38,424,786
Revenue:				
Local	\$14,666,025	\$104,000	\$20,625,000	\$35,395,025
State	\$50,000	\$4,192,766	\$1,550,000	\$5,792,766
Federal	\$0	\$1,086,000	\$87,474,626	\$88,560,626
Transfers/Other	\$1,770,200	\$0	\$0	\$1,770,200
Total Revenue	<u>\$16,486,225</u>	<u>\$5,382,766</u>	<u>\$109,649,626</u>	<u>\$131,518,617</u>
Appropriations				
Instruction	\$3,171,466	\$3,938,160	\$21,371,452	\$28,481,078
Pupil Support Services	\$0	\$843,019	\$4,751,444	\$5,594,463
Improvement of Instr Svcs	\$144,874	\$521,451	\$8,473,680	\$9,140,005
Educational Media Services	\$7,748	\$0	\$0	\$7,748
Instructional Staff Training	\$0	\$0	\$11,808,290	\$11,808,290
Federal Grant Administratic	\$0	\$0	\$977,748	\$977,748
General Administration	\$50,000	\$33,702	\$1,757,668	\$1,841,370
School Administration	\$23,245	\$1,300	\$0	\$24,545
Support Services-Business	\$0	\$0	\$28,173	\$28,173
Maint. & Oper of Plant Svc	\$1,942,311	\$40,134	\$26,582	\$2,009,027
Student Transportation	\$0	\$5,000	\$1,741,936	\$1,746,936
Support Services - Central	\$0	\$0	\$163,749	\$163,749
Other Support Services	\$0	\$0	\$20,693	\$20,693
School Nutrition Program	\$0	\$0	\$63,042,378	\$63,042,378
Enterprise Operations	\$0	\$0	\$0	\$0
Community Services	\$11,146,581	\$0	\$0	\$11,146,581
Capital Outlay	\$0	\$0	\$0	\$0
Transfers	\$0	\$0	\$0	\$0
Debt Service	\$0	\$0	\$0	\$0
Total Appropriations	<u>\$16,486,225</u>	<u>\$5,382,766</u>	<u>\$114,163,793</u>	<u>\$136,032,784</u>
Ending Fund Balance (Estimate)				
June 30, 2023	<u>\$8,154,906</u>	<u>\$189,306</u>	<u>\$25,566,407</u>	<u>\$33,910,619</u>

**SPECIAL REVENUE FUNDS
SPECIAL PROGRAMS
FY2023 BUDGET**

Description	Fund 549 Donation	Fund 550 Venue Management	Fund 551 After School Program	Fund 552 Performing Arts Program	Fund 553 Tuition School Program
Beginning Fund Balance July 1, 2022 (Estimated)	\$826,175	\$347,749	\$2,970,028	\$467,123	\$2,444,793
Revenue:					
Local	\$0	\$1,500,000	\$10,774,828	\$422,760	\$1,399,702
State	\$0	\$0	\$0	\$0	\$0
Federal	\$0	\$0	\$0	\$0	\$0
Transfers/Other	\$0	\$0	\$0	\$0	\$0
Total Revenue	\$0	\$1,500,000	\$10,774,828	\$422,760	\$1,399,702
Appropriations					
Instruction	\$0	\$0	\$1,356,963	\$422,760	\$1,222,389
Pupil Support Services	\$0	\$0	\$0	\$0	\$0
Improvement of Instr Svcs	\$0	\$0	\$0	\$0	\$144,874
Educational Media Services	\$0	\$0	\$0	\$0	\$7,748
Instructional Staff Training	\$0	\$0	\$0	\$0	\$0
Federal Grant Administration	\$0	\$0	\$0	\$0	\$0
General Administration	\$0	\$0	\$0	\$0	\$0
School Administration	\$0	\$0	\$0	\$0	\$23,245
Support Services-Business	\$0	\$0	\$0	\$0	\$0
Maint. & Oper of Plant Svcs	\$0	\$0	\$0	\$0	\$1,446
Student Transportation	\$0	\$0	\$0	\$0	\$0
Support Services - Central	\$0	\$0	\$0	\$0	\$0
Other Support Services	\$0	\$0	\$0	\$0	\$0
School Nutrition Program	\$0	\$0	\$0	\$0	\$0
Enterprise Operations	\$0	\$0	\$0	\$0	\$0
Community Services	\$0	\$1,500,000	\$9,417,865	\$0	\$0
Capital Outlay	\$0	\$0	\$0	\$0	\$0
Transfers	\$0	\$0	\$0	\$0	\$0
Debt Service	\$0	\$0	\$0	\$0	\$0
Total Appropriations	\$0	\$1,500,000	\$10,774,828	\$422,760	\$1,399,702
Ending Fund Balance					
June 30, 2023 (Estimated)	\$826,175	\$347,749	\$2,970,028	\$467,123	\$2,444,793

**SPECIAL REVENUE FUNDS
SPECIAL PROGRAMS (Continued)
FY2023 BUDGET**

Description	Fund 554 Public Safety	Fund 556 Adult High School	Fund 557 Artists at School	Fund 580 Miscellaneous Grants	Total
Beginning Fund Balance July 1, 2022 (Estimated)	\$321,816	\$482,511	\$16,325	\$278,385	\$8,154,906
Revenue:					
Local	\$450,000	\$21,135	\$2,600	\$95,000	\$14,666,025
State	\$0	\$0	\$0	\$50,000	\$50,000
Federal	\$0	\$0	\$0	\$0	\$0
Transfers/Other	\$1,490,865	\$279,335	\$0	\$0	\$1,770,200
Total Revenue	\$1,940,865	\$300,470	\$2,600	\$145,000	\$16,486,225
Appropriations					
Instruction	\$0	\$71,754	\$2,600	\$95,000	\$3,171,466
Pupil Support Services	\$0	\$0	\$0	\$0	\$0
Improvement of Instr Svcs	\$0	\$0	\$0	\$0	\$144,874
Educational Media Services	\$0	\$0	\$0	\$0	\$7,748
Instructional Staff Training	\$0	\$0	\$0	\$0	\$0
Federal Grant Administration	\$0	\$0	\$0	\$0	\$0
General Administration	\$0	\$0	\$0	\$50,000	\$50,000
School Administration	\$0	\$0	\$0	\$0	\$23,245
Support Services-Business	\$0	\$0	\$0	\$0	\$0
Maint. & Oper of Plant Svcs	\$1,940,865	\$0	\$0	\$0	\$1,942,311
Student Transportation	\$0	\$0	\$0	\$0	\$0
Support Services - Central	\$0	\$0	\$0	\$0	\$0
Other Support Services	\$0	\$0	\$0	\$0	\$0
School Nutrition Program	\$0	\$0	\$0	\$0	\$0
Enterprise Operations	\$0	\$0	\$0	\$0	\$0
Community Services	\$0	\$228,716	\$0	\$0	\$11,146,581
Capital Outlay	\$0	\$0	\$0	\$0	\$0
Transfers	\$0	\$0	\$0	\$0	\$0
Debt Service	\$0	\$0	\$0	\$0	\$0
Total Appropriations	\$1,940,865	\$300,470	\$2,600	\$145,000	\$16,486,225
Ending Fund Balance					
June 30, 2023 (Estimated)	\$321,816	\$482,511	\$16,325	\$278,385	\$8,154,906

**SPECIAL REVENUE FUNDS
STATE AID
FY2023 BUDGET**

Description	Fund 510 Adult Education	Fund 532 GNETS	Fund 560 Pre-K Lottery	Total
Beginning Fund Balance (Estimate)				
July 1, 2021	\$0	\$189,306	\$0	\$189,306
Revenue:				
Local	\$0	\$104,000	\$0	\$104,000
State	\$443,700	\$3,370,122	\$378,944	\$4,192,766
Federal	\$721,000	\$365,000	\$0	\$1,086,000
Transfers/Other	\$0	\$0	\$0	\$0
Total Revenue	\$1,164,700	\$3,839,122	\$378,944	\$5,382,766
Appropriations				
Instruction	\$706,481	\$2,852,735	\$378,944	\$3,938,160
Pupil Support Services	\$0	\$843,019	\$0	\$843,019
Improvement of Instr Svcs	\$423,356	\$98,095	\$0	\$521,451
Educational Media Services	\$0	\$0	\$0	\$0
Instructional Staff Training	\$0	\$0	\$0	\$0
Federal Grant Administratic	\$0	\$0	\$0	\$0
General Administration	\$0	\$33,702	\$0	\$33,702
School Administration	\$0	\$1,300	\$0	\$1,300
Support Services-Business	\$0	\$0	\$0	\$0
Maint. & Oper of Plant Svc	\$34,863	\$5,271	\$0	\$40,134
Student Transportation	\$0	\$5,000	\$0	\$5,000
Support Services - Central	\$0	\$0	\$0	\$0
Other Support Services	\$0	\$0	\$0	\$0
School Nutrition Program	\$0	\$0	\$0	\$0
Enterprise Operations	\$0	\$0	\$0	\$0
Community Services	\$0	\$0	\$0	\$0
Capital Outlay	\$0	\$0	\$0	\$0
Transfers	\$0	\$0	\$0	\$0
Debt Service	\$0	\$0	\$0	\$0
Total Appropriations	\$1,164,700	\$3,839,122	\$378,944	\$5,382,766
Ending Fund Balance (Estimate)				
June 30, 2022	\$0	\$189,306	\$0	\$189,306

**SPECIAL REVENUE FUNDS
FEDERAL AID
FY2023 BUDGET**

Description	Fund 402 Title I	Fund 404 IDEA	Fund 406 Vocational Education	Fund 414 Title II	Fund 420 CARES Act Relief	Fund 432 Homeless Grant	Fund 448 ARP
Beginning Fund Balance July 1, 2021 (Estimated)	\$0	\$0	\$0	\$0	\$0	\$0	\$0
Revenue:							
Local	\$0	\$0	\$0	\$0	\$0	\$0	\$0
State	\$0	\$0	\$0	\$0	\$0	\$0	\$0
Federal	\$21,541,138	\$21,945,218	\$780,716	\$2,799,744	\$0	\$83,380	\$0
Transfers/Other	\$0	\$0	\$0	\$0	\$0	\$0	\$0
Total Revenue	\$21,541,138	\$21,945,218	\$780,716	\$2,799,744	\$0	\$83,380	\$0
Appropriations							
Instruction	\$9,528,539	\$9,614,069	\$722,779	\$0	\$0	\$0	\$0
Pupil Support Services	\$2,001,276	\$2,163,297	\$0	\$0	\$0	\$1,152	\$0
Improvement of Instr Svcs	\$355,827	\$7,351,286	\$0	\$0	\$0	\$0	\$0
Educational Media Services	\$0	\$0	\$0	\$0	\$0	\$0	\$0
Instructional Staff Training	\$8,472,908	\$0	\$25,000	\$2,460,690	\$0	\$0	\$0
Federal Grant Administratic	\$689,328	\$0	\$19,450	\$115,802	\$0	\$79,449	\$0
General Administration	\$459,570	\$1,151,456	\$13,487	\$59,503	\$0	\$1,779	\$0
School Administration	\$0	\$0	\$0	\$0	\$0	\$0	\$0
Support Services-Business	\$0	\$0	\$0	\$0	\$0	\$0	\$0
Maint. & Oper of Plant Svc	\$0	\$0	\$0	\$0	\$0	\$0	\$0
Student Transportation	\$33,690	\$1,665,110	\$0	\$0	\$0	\$1,000	\$0
Support Services - Central	\$0	\$0	\$0	\$163,749	\$0	\$0	\$0
Other Support Services	\$0	\$0	\$0	\$0	\$0	\$0	\$0
School Nutrition Program	\$0	\$0	\$0	\$0	\$0	\$0	\$0
Enterprise Operations	\$0	\$0	\$0	\$0	\$0	\$0	\$0
Community Services	\$0	\$0	\$0	\$0	\$0	\$0	\$0
Capital Outlay	\$0	\$0	\$0	\$0	\$0	\$0	\$0
Transfers	\$0	\$0	\$0	\$0	\$0	\$0	\$0
Debt Service	\$0	\$0	\$0	\$0	\$0	\$0	\$0
Total Appropriations	\$21,541,138	\$21,945,218	\$780,716	\$2,799,744	\$0	\$83,380	\$0
Ending Fund Balance June 30, 2022 (Estimated)	\$0	\$0	\$0	\$0	\$0	\$0	\$0

**SPECIAL REVENUE FUNDS
FEDERAL AID (Continued)
FY2023 BUDGET**

Description	Fund 460 Title III	Fund 462 Title IV	Fund 478 USDA Fruits and Vegetables	Fund 600 School Nutrition	Total
Beginning Fund Balance July 1, 2021 (Estimated)	\$0	\$0	\$0	\$30,080,574	\$30,080,574
Revenue:					
Local	\$0	\$0	\$0	\$20,625,000	\$20,625,000
State	\$0	\$0	\$0	\$1,550,000	\$1,550,000
Federal	\$1,568,146	\$2,403,073	\$183,211	\$36,170,000	\$87,474,626
Transfers/Other	\$0	\$0	\$0	\$0	\$0
Total Revenue	\$1,568,146	\$2,403,073	\$183,211	\$58,345,000	\$109,649,626
Appropriations					
Instruction	\$454,817	\$1,051,248	\$0	\$0	\$21,371,452
Pupil Support Services	\$157,786	\$427,933	\$0	\$0	\$4,751,444
Improvement of Instr Svcs	\$615,225	\$151,342	\$0	\$0	\$8,473,680
Educational Media Services	\$0	\$0	\$0	\$0	\$0
Instructional Staff Training	\$324,928	\$524,764	\$0	\$0	\$11,808,290
Federal Grant Administratic	\$0	\$73,719	\$0	\$0	\$977,748
General Administration	\$15,390	\$56,483	\$0	\$0	\$1,757,668
School Administration	\$0	\$0	\$0	\$0	\$0
Support Services-Business	\$0	\$28,173	\$0	\$0	\$28,173
Maint. & Oper of Plant Svc	\$0	\$26,582	\$0	\$0	\$26,582
Student Transportation	\$0	\$42,136	\$0	\$0	\$1,741,936
Support Services - Central	\$0	\$0	\$0	\$0	\$163,749
Other Support Services	\$0	\$20,693	\$0	\$0	\$20,693
School Nutrition Program	\$0	\$0	\$183,211	\$62,859,167	\$63,042,378
Enterprise Operations	\$0	\$0	\$0	\$0	\$0
Community Services	\$0	\$0	\$0	\$0	\$0
Capital Outlay	\$0	\$0	\$0	\$0	\$0
Transfers	\$0	\$0	\$0	\$0	\$0
Debt Service	\$0	\$0	\$0	\$0	\$0
Total Appropriations	\$1,568,146	\$2,403,073	\$183,211	\$62,859,167	\$114,163,793
Ending Fund Balance June 30, 2022 (Estimated)	\$0	\$0	\$0	\$25,566,407	\$25,566,407

Debt Service Fund

DEBT SERVICE FUND BUDGET

The Debt Service fund is established to account for the accumulation of resources for and the payment of general long-term debt principal and interest. The District is now debt free.

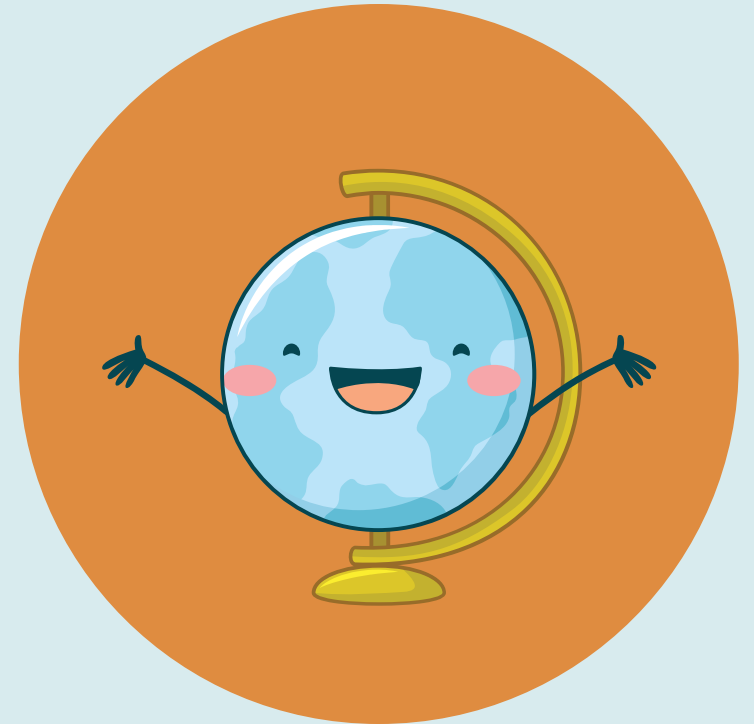

**DEBT SERVICE FUND
REVENUE AND APPROPRIATIONS (FUNCTION)
EIGHT YEAR COMPARISON**

Description	FY2019 Actual	FY2020 Actual	FY2021 Actual	FY2022 Revised Budget	FY2023 Approved Budget	FY2024 Forecast	FY2025 Forecast	FY2026 Forecast
Beginning Fund Balance July 1 (Estimated)	\$0	\$0	\$0	\$0	\$0	\$0	\$0	\$0
<u>Revenue:</u>								
Local	\$0	\$0	\$0	\$0	\$0	\$0	\$0	\$0
State	\$0	\$0	\$0	\$0	\$0	\$0	\$0	\$0
Federal	\$0	\$0	\$0	\$0	\$0	\$0	\$0	\$0
Transfers/Other	\$0	\$0	\$0	\$0	\$0	\$0	\$0	\$0
Total Revenue	\$0	\$0	\$0	\$0	\$0	\$0	\$0	\$0
Total Revenue & Fund Balance	\$0	\$0	\$0	\$0	\$0	\$0	\$0	\$0
<u>Appropriations</u>								
Instruction	\$0	\$0	\$0	\$0	\$0	\$0	\$0	\$0
Pupil Support Services	\$0	\$0	\$0	\$0	\$0	\$0	\$0	\$0
Improvement of Instr Svcs	\$0	\$0	\$0	\$0	\$0	\$0	\$0	\$0
Educational Media Services	\$0	\$0	\$0	\$0	\$0	\$0	\$0	\$0
Instructional Staff Training	\$0	\$0	\$0	\$0	\$0	\$0	\$0	\$0
Federal Grant Administration	\$0	\$0	\$0	\$0	\$0	\$0	\$0	\$0
General Administration	\$0	\$0	\$0	\$0	\$0	\$0	\$0	\$0
School Administration	\$0	\$0	\$0	\$0	\$0	\$0	\$0	\$0
Support Services-Business	\$0	\$0	\$0	\$0	\$0	\$0	\$0	\$0
Maint. & Oper of Plant Svcs	\$0	\$0	\$0	\$0	\$0	\$0	\$0	\$0
Student Transportation	\$0	\$0	\$0	\$0	\$0	\$0	\$0	\$0
Support Services - Central	\$0	\$0	\$0	\$0	\$0	\$0	\$0	\$0
Other Support Services	\$0	\$0	\$0	\$0	\$0	\$0	\$0	\$0
School Nutrition Program	\$0	\$0	\$0	\$0	\$0	\$0	\$0	\$0
Enterprise Operations	\$0	\$0	\$0	\$0	\$0	\$0	\$0	\$0
Community Services	\$0	\$0	\$0	\$0	\$0	\$0	\$0	\$0
Capital Outlay	\$0	\$0	\$0	\$0	\$0	\$0	\$0	\$0
Transfers	\$0	\$0	\$0	\$0	\$0	\$0	\$0	\$0
Debt Service	\$0	\$0	\$0	\$0	\$0	\$0	\$0	\$0
Total Appropriations	\$0	\$0	\$0	\$0	\$0	\$0	\$0	\$0
Ending Fund Balance June 30 (Estimated)	\$0	\$0	\$0	\$0	\$0	\$0	\$0	\$0
Total Expenditures & Fund Balance	\$0	\$0	\$0	\$0	\$0	\$0	\$0	\$0

Note: In fiscal year 2007, the District paid off all its outstanding general obligation bonds. The Debt Service Fund balance ended in FY2016.

**DEBT SERVICE FUND
REVENUE AND APPROPRIATIONS (OBJECT)
EIGHT YEAR COMPARISON**

	FY2019	FY2020	FY2021	FY2022	FY2023	FY2024	FY2025	FY2026
Description	Actual	Actual	Actual	Revised Budget	Approved Budget	Forecast	Forecast	Forecast
Beginning Fund Balance								
July 1 (Estimated)	\$0	\$0	\$0	\$0	\$0	\$0	\$0	\$0
Revenue:								
Local	\$0	\$0	\$0	\$0	\$0	\$0	\$0	\$0
State	\$0	\$0	\$0	\$0	\$0	\$0	\$0	\$0
Federal	\$0	\$0	\$0	\$0	\$0	\$0	\$0	\$0
Transfers/Other	\$0	\$0	\$0	\$0	\$0	\$0	\$0	\$0
Total Revenue	\$0	\$0	\$0	\$0	\$0	\$0	\$0	\$0
Total Revenue & Fund Balance	\$0	\$0	\$0	\$0	\$0	\$0	\$0	\$0
Appropriations								
51 Salaries	\$0	\$0	\$0	\$0	\$0	\$0	\$0	\$0
52 Employee Benefits	\$0	\$0	\$0	\$0	\$0	\$0	\$0	\$0
53 Contract Services	\$0	\$0	\$0	\$0	\$0	\$0	\$0	\$0
54 Repair and Rental w Water	\$0	\$0	\$0	\$0	\$0	\$0	\$0	\$0
55 Other Purchases w Telephone	\$0	\$0	\$0	\$0	\$0	\$0	\$0	\$0
56 Supplies and Equipments w Utilitie	\$0	\$0	\$0	\$0	\$0	\$0	\$0	\$0
58 Dues and Other Fees	\$0	\$0	\$0	\$0	\$0	\$0	\$0	\$0
59 Transfers	\$0	\$0	\$0	\$0	\$0	\$0	\$0	\$0
66 Fixed Assets Equipt	\$0	\$0	\$0	\$0	\$0	\$0	\$0	\$0
67 Fixed Assets CIP w Bldgs/Land	\$0	\$0	\$0	\$0	\$0	\$0	\$0	\$0
68 Other	\$0	\$0	\$0	\$0	\$0	\$0	\$0	\$0
Total Appropriations	\$0	\$0	\$0	\$0	\$0	\$0	\$0	\$0
Ending Fund Balance	\$0	\$0	\$0	\$0	\$0	\$0	\$0	\$0
June 30 (Estimated)								
Total Expenditures & Fund Balance	\$0	\$0	\$0	\$0	\$0	\$0	\$0	\$0

Note: In fiscal year 2007, the District paid off all its outstanding general obligation bonds. The Debt Service Fund balance ended in FY2016.

**DEBT SERVICE FUND
FIVE YEAR TREND OF FUND BALANCE**

\$ Millions

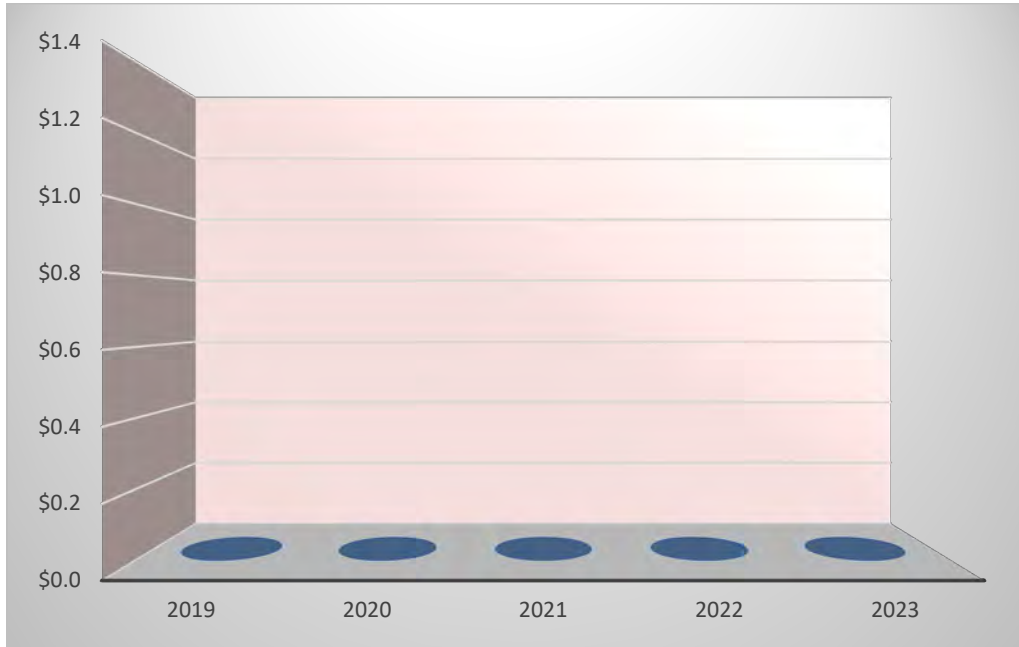

DEBT SERVICE FUND BOND DEBT ISSUES

DEBT REVENUE AND POLICY

Debt Service Fund Revenue Sources/Assumptions

Whenever the District and the citizens of Cobb County make a decision to incur long term debt, debt retirement is funded in the Debt Service fund with local property taxes. This debt would be serviced via a special millage tax rate assessed as property tax to pay remaining principal and interest payments.

Debt Administration

In fiscal year 2007, the District paid off all its outstanding general obligation bonds. The District's general obligation bonded debt issuances are subject to a legal limitation based on 10% of total assessed value of real and personal property. As of June 30, 2021, the District's net general obligation bonded debt of \$0 was well below the legal limit of \$3,149,684,074 (10% of District Net Assessed Value). Net bonded debt per capita equaled \$0. With capital leases, debt per capita is \$0.

The District has maintained its highest Long-Term Credit Rating for a governmental entity from both **Moody's Investor's Service** and **Standard & Poor's Corporation**. On December 17, 2015, Moody's reviewed the business fundamentals and financial condition of the District and assigned CCSD a **Aaa** credit rating. In December 2020, Standard & Poor's assigned **AAA** to the District. In December 2021, the District received a **AAA** rating from **Kroll Bond Rating Agency**. This exceptional credit rating from all three agencies is reaffirmed for 2022. These ratings are the highest rating available to governmental entities.

DISTRICT IS LONG-TERM DEBT FREE

The Cobb County School District has an extremely conservative approach to long-term debt. The District has a well-developed multi-year capital plan where the funding source methodology is a pay-as-you-go philosophy that associates with the Special Purpose Local Option Sales Tax (SPLOST) revenues and State of Georgia Capital Project funding.

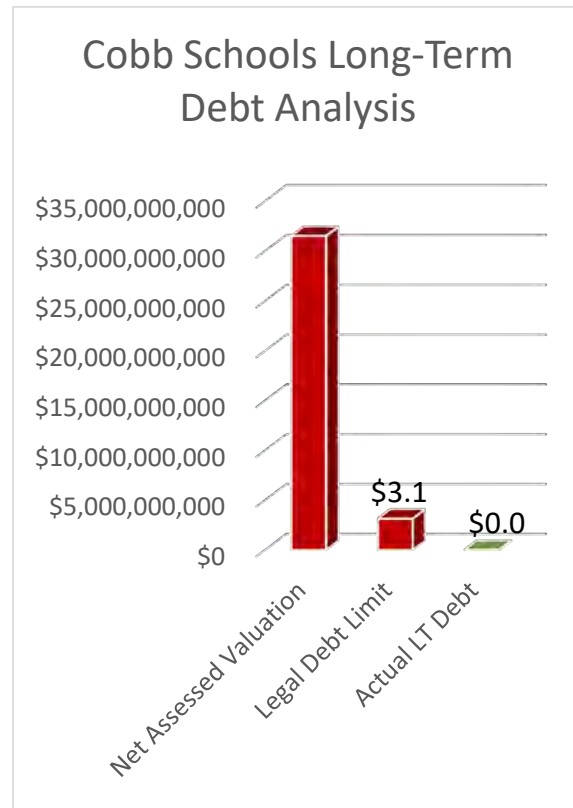

**DEBT SERVICE FUND
BOND DEBT ISSUES (Continued)**

DEBT MANAGEMENT

Debt Service to General Fund Ratios –

Fiscal Year	Debt Service Expenditures	General Fund Expenditures	Ratio of Debt Service Fund to General Fund Expenditures
FY2006	\$46,158,000	\$754,681,000	6.12%
FY2007	\$46,571,000	\$855,178,000	5.45%
FY2008	\$0	\$931,690,000	0.00%
FY2009	\$0	\$932,214,000	0.00%
FY2010	\$0	\$863,036,000	0.00%
FY2011	\$0	\$821,638,000	0.00%
FY2012	\$0	\$839,615,000	0.00%
FY2013	\$0	\$834,752,000	0.00%
FY2014	\$0	\$835,694,000	0.00%
FY2015	\$0	\$894,795,345	0.00%
FY2016	\$0	\$964,543,251	0.00%
FY2017	\$0	\$995,115,273	0.00%
FY2018	\$0	\$1,025,939,158	0.00%
FY2019	\$0	\$1,075,653,909	0.00%
FY2020	\$0	\$1,156,288,445	0.00%
FY2021	\$0	\$1,061,392,233	0.00%
FY2022	\$0	\$1,219,274,725	0.00%

Capital Projects Fund

CAPITAL PROJECTS FUND BUDGET

These funds are established to provide accounting for financial resources to be used for the acquisition and construction of major capital facilities. The District currently has three funds used for that purpose: the District Building Fund, SPLOST 4 and SPLOST 5.



**CAPITAL PROJECTS FUND
REVENUES AND APPROPRIATIONS (FUNCTION)
EIGHT YEAR COMPARISON**

Description	FY2019 Actual	FY2020 Actual	FY2021 Actual	FY2022 Estimated Actual	FY2023 Approved Budget	FY2024 Forecast	FY2025 Forecast	FY2026 Forecast
Beginning Fund Balance July 1 (Estimated)	\$110,654,317	\$88,335,346	\$36,318,087	\$41,847,843	\$116,513,029	\$153,588,376	\$170,482,338	\$207,633,952
Revenue:								
Local	\$148,649,830	\$146,017,478	\$165,751,477	\$190,827,604	\$158,273,911	\$150,936,967	\$168,133,375	\$174,061,888
State	\$3,189,132	\$17,437,771	\$2,201,544	\$7,758,641	\$2,400,432	\$232,473	\$4,323,480	\$2,733,173
Bond Proceeds	\$0	\$0	\$0	\$0	\$0	\$0	\$0	\$0
Transfers/Other	\$2,630,642	\$9,319,536	\$2,807,397	\$5,540,962	\$1,000,000	\$1,000,000	\$1,000,000	\$1,000,000
Total Revenue	\$154,469,604	\$172,774,785	\$170,760,418	\$204,127,207	\$161,674,343	\$152,169,440	\$173,456,855	\$177,795,061
Total Revenue & Fund Balance	\$265,123,921	\$261,110,131	\$207,078,505	\$245,975,050	\$278,187,372	\$305,757,816	\$343,939,193	\$385,429,013
Appropriations								
Instruction	\$0	\$0	\$0	\$0	\$0	\$0	\$0	\$0
Pupil Support Services	\$0	\$0	\$0	\$0	\$0	\$0	\$0	\$0
Improvement of Instr Svcs	\$0	\$0	\$0	\$0	\$0	\$0	\$0	\$0
General Administration	\$0	\$0	\$0	\$0	\$0	\$0	\$0	\$0
School Administration	\$0	\$0	\$0	\$0	\$0	\$0	\$0	\$0
Support Services-Business	\$0	\$0	\$0	\$0	\$0	\$0	\$0	\$0
Maint. & Oper. Of Plant Svcs	\$0	\$0	\$0	\$0	\$0	\$0	\$0	\$0
Student Transportation	\$0	\$0	\$0	\$0	\$0	\$0	\$0	\$0
Central Support Services	\$0	\$0	\$0	\$0	\$0	\$0	\$0	\$0
School Nutrition	\$0	\$0	\$0	\$0	\$0	\$0	\$0	\$0
Facilities Acquisitions & Construction Services	\$172,514,377	\$221,875,664	\$163,574,839	\$128,734,651	\$123,598,996	\$134,275,478	\$135,305,241	\$134,029,804
Transfers/Other	\$4,274,198	\$2,916,380	\$1,655,823	\$727,370	\$1,000,000	\$1,000,000	\$1,000,000	\$1,000,000
Total Appropriations	\$176,788,575	\$224,792,044	\$165,230,662	\$129,462,021	\$124,598,996	\$135,275,478	\$136,305,241	\$135,029,804
Ending Fund Balance June 30 (Estimated)	\$88,335,346	\$36,318,087	\$41,847,843	\$116,513,029	\$153,588,376	\$170,482,338	\$207,633,952	\$250,399,209
Total Expenditures & Fund Balance	\$265,123,921	\$261,110,131	\$207,078,505	\$245,975,050	\$278,187,372	\$305,757,816	\$343,939,193	\$385,429,013

Note:

- Several construction projects and technology initiatives have been accelerated in FY2020 resulting in increased expenditures and decreased fund balance.
- SPLOST 5 Revenue was higher than projected in FY2022.
- Forecasts on FY2024, FY2025, FY2026: Revenue projection based on SPLOST 5 Monthly Revenue Projection Schedule - Five Years FY2020-FY2024, SPLOST 4 Interest, State Capital Outlay, Annual District Building Fund Budget, and projected SPLOST 6 Revenue. Expenditure projection based on Cash Flow Projections.

**CAPITAL PROJECTS FUND
REVENUES AND APPROPRIATIONS (OBJECT)
EIGHT YEAR COMPARISON**

Description	FY2019 Actual	FY2020 Actual	FY2021 Actual	FY2022 Estimated Actual	FY2023 Approved Budget	FY2024 Forecast	FY2025 Forecast	FY2026 Forecast
Beginning Fund Balance July 1 (Estimated)	\$110,654,317	\$88,335,346	\$36,318,087	\$41,847,843	\$116,513,029	\$153,588,376	\$170,482,338	\$207,633,952
Revenue:								
Local	\$148,649,830	\$146,017,478	\$165,751,477	\$190,827,604	\$158,273,911	\$150,936,967	\$168,133,375	\$174,061,888
State	\$3,189,132	\$17,437,771	\$2,201,544	\$7,758,641	\$2,400,432	\$232,473	\$4,323,480	\$2,733,173
Bond Proceeds	\$0	\$0	\$0	\$0	\$0	\$0	\$0	\$0
Transfers/Other	\$2,630,642	\$9,319,536	\$2,807,397	\$5,540,962	\$1,000,000	\$1,000,000	\$1,000,000	\$1,000,000
Total Revenue	\$154,469,604	\$172,774,785	\$170,760,418	\$204,127,207	\$161,674,343	\$152,169,440	\$173,456,855	\$177,795,061
Total Revenue & Fund Balance	\$265,123,921	\$261,110,131	\$207,078,505	\$245,975,050	\$278,187,372	\$305,757,816	\$343,939,193	\$385,429,013
Appropriations								
Salaries	\$2,725,448	\$2,996,934	\$2,883,814	\$2,994,688	\$3,326,947	\$3,393,496	\$3,461,356	\$3,530,583
Employee Benefits	\$1,076,429	\$1,197,365	\$1,075,199	\$1,122,791	\$1,313,989	\$1,340,269	\$1,367,074	\$1,394,416
Contract Services	\$1,962,031	\$1,366,648	\$1,186,060	\$306,865	\$298,318	\$324,661	\$327,133	\$324,072
Supplies	\$17,696,133	\$14,763,233	\$9,647,108	\$10,804,255	\$10,316,817	\$11,227,865	\$11,313,335	\$11,207,474
Utilities	\$0	\$0	\$0	\$0	\$0	\$0	\$0	\$0
Equipment/Bldgs/Land	\$149,054,336	\$202,105,316	\$148,782,658	\$113,506,052	\$108,342,925	\$117,989,187	\$118,836,343	\$117,573,259
Transfers/Other	\$4,274,198	\$2,362,548	\$1,655,823	\$727,370	\$1,000,000	\$1,000,000	\$1,000,000	\$1,000,000
Total Appropriations	\$176,788,575	\$224,792,044	\$165,230,662	\$129,462,021	\$124,598,996	\$135,275,478	\$136,305,241	\$135,029,804
Ending Fund Balance June 30 (Estimated)	\$88,335,346	\$36,318,087	\$41,847,843	\$116,513,029	\$153,588,376	\$170,482,338	\$207,633,952	\$250,399,209
Total Expenditures & Fund Balance	\$265,123,921	\$261,110,131	\$207,078,505	\$245,975,050	\$278,187,372	\$305,757,816	\$343,939,193	\$385,429,013

Note:

- Several construction projects and technology initiatives have been accelerated in FY2020 resulting in increased expenditures and decreased fund balance.
- SPLOST 5 Revenue was higher than projected in FY2022.
- Forecasts on FY2024, FY2025, FY2026: Revenue projection based on SPLOST 5 Monthly Revenue Projection Schedule - Five Years FY2020-FY2024, SPLOST 4 Interest, State Capital Outlay, Annual District Building Fund Budget, and projected SPLOST 6 Revenue. Expenditure projection based on Cash Flow Projections.

**CAPITAL PROJECTS FUND
FIVE YEAR TREND OF FUND BALANCE**

\$ Millions

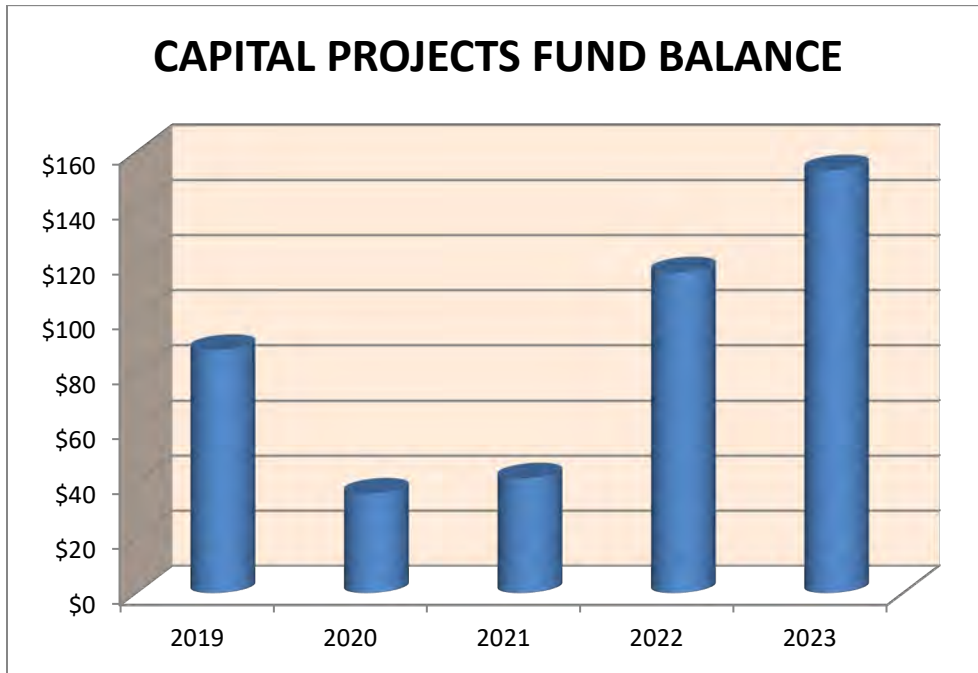

CAPITAL PROJECT FUNDS CAPITAL PROJECTS DESCRIPTION

Capital Project Revenue Sources

The Georgia Legislature passed a law allowing school districts to establish a one-cent sales tax that would be used for capital projects or debt retirement. On September 15, 1998, Cobb County citizens voted and approved SPLOST 1 (Special Purpose Local Option Sales Tax), the five-year funding source that assisted the School District in building new schools, supplying additional classrooms and equipment and providing for the technology needs of a growing school district. On September 16, 2003, the voters approved SPLOST 2, the renewal of this one-cent sales tax for an additional five years. Again, on September 16, 2008, the District held a referendum for an extension of current SPLOST, which also passed. This SPLOST 3 expired on December 31, 2013 and all funds were expended in FY2019. On March 19, 2013, a fourth SPLOST was approved for the period January 1, 2014 – December 31, 2018. A fifth SPLOST was presented to the voters and approved on March 21, 2017, for the period January 1, 2019 – December 31, 2023. The projected total five-year receipt is \$797,022,000. A sixth SPLOST was presented to the voters and approved for the period of January 1, 2024 – December 31, 2028. The projected five-year receipt is \$894,891,903.

SPLOST 5 funding includes categories for facility improvements such as new and replacement schools, additions, modifications, renovations and maintenance; safety and support items such as school buses, textbooks, security fencing, access controls, surveillance cameras, furniture and equipment; and technology initiatives including audio visual equipment, interactive classrooms, district server, copier and printer replacement, computing devices for teachers and other staff, network maintenance, phone system enhancement and music equipment.

Many Cobb schools are more than 40 years old and have inadequate space and resources to best serve students. SPLOST 5 is focused on giving new life to existing facilities, replacing some of the District's oldest and least efficient school buildings and refreshing the District's technology resources and infrastructure.

Impact of Capital Investments and Nonrecurring Expenditures on Operating Budget of General Fund

With the opening of any new school, the General Fund is forced to absorb the additional costs of school operations. Examples of these include new school salaries, utilities costs and school supplies/equipment (New schools get a 100% increase of instructional supply fund allocation for two years). Note that these additional operating costs are funded primarily through local funding sources, such as property taxes and state funding. All new schools that have been constructed since 2008 have been replacement facilities except for the Cobb Career Academy and Pearson Middle School; thereby the effect on the General Fund Operating Budget has been minimal. The Capital Project budget and finance funding rules and procedures are presented separately following this description document.

Replacement Schools

In FY2020, SPLOST 4 funds were used to continue construction of Walton and Osborne High Schools and the new Cobb Innovation and Technology Academy. SPLOST 5 funds were used to build two replacement schools, Clay-Harmony Leland and King Springs Elementary Schools.

**CAPITAL PROJECT FUNDS
CAPITAL PROJECTS DESCRIPTION (Continued)**

In FY2021, SPLOST 4 funds were used to continue construction of Osborne High School. In addition, SPLOST 5 funds were used for construction of the new Pearson Middle School as well as classroom additions at Campbell and Pebblebrook High Schools.

SPLOST V Five Year Budget

A referendum was held March 21, 2017 to extend the tax another five years of SPLOST program.

REVENUE

Projected Total SPLOST Receipts (5 years)	\$797,022,000
--	---------------

EXPENDITURES

New/Replacement Facilities	\$165,000,000
Additions/Modifications	\$206,000,000
Infrastructure/Individual School Needs	\$103,000,000
Safety, Security, and Support	\$150,022,000
Academic/Technology	\$173,000,000

New and Replacement Facilities

- Ed-SPLOST V calls for replacement facilities for Eastvalley, Clay, Harmony Leland, and King Springs Elementary Schools, and a new Pearson Middle School.
- Constructing approximately 210 new classrooms.

Additions/Modifications

- Adding to existing facilities approximately 137 classrooms (26 at middle school level and 111 at high school level).
- Constructing major additions/modifications/renovations at the following locations: Campbell, Hillgrove, Lassiter, North Cobb, Osborne, Pebblebrook, South Cobb, Sprayberry, Walton and Wheeler High Schools, and Dickerson, Dodgen, and Lovinggood Middle Schools.

Maintenance/Renovation

- Maintenance projects including new canopies, roofing, toilet room renovations, playground equipment, flooring, painting, lighting upgrades, energy management systems, HVAC, plumbing, and various electrical upgrades.
- Artificial turf replacement
- Renovations to food service facilities and replacement of large kitchen equipment.

**CAPITAL PROJECT FUNDS
CAPITAL PROJECTS DESCRIPTION (Continued)**

Safety, Security, and Support

- Continue to improve school safety by adding access controls, surveillance cameras, security fencing, signage, traffic controls and replacing the outdated radio communications system.
- Provide support functions, including school buses, maintenance vehicles and equipment, school-level equipment for growth and replacement, student information systems enhancement and replacement of the human resources, payroll, and financial applications and equipment.
- Renovations and equipment purchases to serve students with disabilities and comply with accessibility provisions of the Americans with Disabilities Act.

Academic/Technology

- Continue to maintain the existing technology infrastructure, as well as upgrading servers, network access control, data center equipment, and phone systems.
- Replace obsolete computing devices, printers, and copiers for classrooms and schools, updating interactive classroom devices, band instruments, instruments and equipment for general/choral instruction.
- Purchase of instructional materials and digital resources.
- Renovations to support innovative learning spaces such as STEM labs, Learning Commons, and Robotics labs.
- Cobb County residents enjoy a high quality of life resulting from the value created by relatively low tax rates, and relatively high academic performance from local schools.

Capital Projects Planned for FY2023 and Beyond

The capital projects that approved by the Board and to be completed in FY2023 and beyond:

<u>Capital Projects</u>	<u>Completion Dates</u>
Belmont Hills ES and Hayes ES Electrical Upgrades	July 2022
Multiple Food & Nutrition Projects at Multiple Schools	July 2022
McEachern HS Plumbing Improvements	July 2022
Bryant ES, Dowell ES and Lewis ES HVAC Improvements	July 2022
Tapp MS Electrical Upgrade	July 2022
Due West ES Flooring and Window Replacement	August 2022
LaBelle ES and Milford ES Flooring Replacement	August 2022
North Cobb HS Roofing Replacement	September 2022
Walton HS Athletic Complex	December 2022
Lovinggood MS Classroom Addition	March 2023
Sprayberry HS Gymnasium and CTAE Renovation	March 2023
Hillgrove HS Classroom Addition	May 2023
Eastvalley ES Replacement School	May 2023
Kennesaw Mountain HS and Mount Bethel ES Roof Replacement	July 2023
Garrison Mill ES and Rocky Mount ES Flooring Replacement	July 2023
Awtrey MS and Daniell MS HVAC Upgrades	July 2023
Hayes ES Food & Nutrition Services Improvements	July 2023

**CAPITAL PROJECT FUNDS
CAPITAL PROJECTS DESCRIPTION (Continued)**

<u>Capital Projects</u>	<u>Completion Dates</u>
Dickerson MS Classroom Addition	July 2023
Dodgen MS Classroom Addition	July 2023
Lassiter HS Theater Renovation (Architect Appointment)	TBD
Pope HS Concession/Restroom Renovation & Replacement	July 2023
North Cobb HS CTAE Renovation	July 2023
Belmont Hills ES Roofing Replacement	September 2023
Sanders ES Roofing Replacement	September 2023
Barber MS and Lost Mountain MS Flooring Replacement	October 2023
Lassiter HS Flooring Replacement	November 2023
Conversion of Lindley 6 th Grade Academy to Betty Gray MS	December 2023
Garrett MS Roof Replacement Phase One	December 2023
Lindley 6 th Grade Academy Classroom addition	December 2023
South Cobb HS Gymnasium Addition & Renovations	August 2024

Capital Project Highlights of FY2022

Major Non-Construction Projects

The following non-construction projects accounted for major expenditures in FY2022:

- District Network Maintenance
- Textbooks/Instructional Materials
- Interactive Classroom Devices
- Replacement of Obsolete Computing Devices
- Learning Management System
- Financial System Enhancement

Largest Construction Projects during the Year

The District makes various contractual commitments on an ongoing basis for construction and remodeling of its fixed assets. The major outstanding commitments as of June 30, 2022 included additions and modifications at Instructional Support Facility, Campbell, Osborne, Pebblebrook, Sprayberry and Walton High Schools. New replacement schools included Eastvalley Elementary School and Horizon High School. As of June 30, 2022, the contract price and expenditures to date for the largest projects were as follows:

<u>Project</u>	<u>Contract Price</u>	<u>Expenditures To Date</u>
Additions/Modifications Instructional Support Facility	\$ 26,863,771	\$ 26,859,657
Additions/Modifications Campbell HS	43,819,208	43,149,178
Additions/Modifications Osborne HS	14,309,045	13,588,073
Additions/Modifications Pebblebrook HS	56,409,301	34,023,667
Additions/Modifications Sprayberry HS	24,318,419	11,051,360
Additions/Modifications Walton HS	8,097,019	1,606,524
New Replacement School Eastvalley ES	39,361,238	5,939,547
New Replacement School Horizon HS Relocation	8,662,538	8,859,543
	<u>\$ 221,840,539</u>	<u>\$ 145,077,549</u>

**CAPITAL PROJECT FUNDS
CAPITAL PROJECTS DESCRIPTION (Continued)**

Capital Project Highlights of FY2021

Major Non-Construction Projects

The following non-construction projects accounted for major expenditures in FY2021:

- District Network Maintenance
- Textbooks/Instructional Materials
- Interactive Classroom Devices
- Replacement of Obsolete Computing Devices
- Learning Management System
- Financial System Enhancement

Largest Construction Projects during the Year

The District makes various contractual commitments on an ongoing basis for construction and remodeling of its fixed assets. The major outstanding commitments as of June 30, 2021 included additions and modifications at Campbell and Pebblebrook High Schools and the Instructional Support Facility. New replacement schools included Horizon High School, Pearson Middle School and Osborne High School. As of June 30, 2021, the contract price and expenditures to date for the largest projects were as follows

<u>Project</u>	<u>Contract Price</u>	<u>Expenditures To Date</u>
Additions/Modifications Instructional Support Facility	\$ 26,353,216	\$ 26,117,576
Additions/Modifications Campbell HS	41,762,076	33,414,693
Additions/Modifications Pebblebrook HS	53,386,763	12,667,191
New Replacement School Horizon HS Relocation	7,275,059	7,009,939
New Replacement School Pearson MS	42,424,306	38,634,377
New Replacement School Osborne HS	58,537,670	55,818,303
	<u>\$ 229,739,090</u>	<u>\$ 173,662,079</u>



**CAPITAL PROJECTS FUND
REVENUES AND APPROPRIATIONS
FY2023 BUDGET**

Description	District Building	SPLOST 4	SPLOST 5	Total
Beginning Fund Balance July 1 (Estimated)	\$6,416,873	\$6,512,032	\$103,584,124	\$116,513,029
Revenue:				
Local	\$0	\$11,181	\$158,262,730	\$158,273,911
State	\$0	\$1,531,516	\$868,916	\$2,400,432
Federal	\$0	\$0	\$0	\$0
Transfers/Other	\$1,000,000	\$0	\$0	\$1,000,000
Total Revenue	\$1,000,000	\$1,542,697	\$159,131,646	\$161,674,343
Appropriations				
Instruction	\$0	\$0	\$0	\$0
Pupil Support Services	\$0	\$0	\$0	\$0
Improvement of Instr Svcs	\$0	\$0	\$0	\$0
General Administration	\$0	\$0	\$0	\$0
School Administration	\$0	\$0	\$0	\$0
Support Services-Business	\$0	\$0	\$0	\$0
Maint. & Oper. Of Plant Svcs	\$0	\$0	\$0	\$0
Student Transportation	\$0	\$0	\$0	\$0
Central Support Services	\$0	\$0	\$0	\$0
Facilities Acquisitions & Construction Svcs	\$0	\$4,405,114	\$119,193,882	\$123,598,996
Transfers/Other	\$1,000,000	\$0	\$0	\$1,000,000
Total Appropriations	\$1,000,000	\$4,405,114	\$119,193,882	\$124,598,996
Ending Fund Balance June 30 (Estimated)	\$6,416,873	\$3,649,615	\$143,521,888	\$153,588,376

CAPITAL PROJECT FUNDS ABOUT SPLOST

Since the first Ed-SPLOST was approved in 1998 we have seen:

- **28 new schools**
- **2,732 new classrooms**
- **Hundreds of maintenance improvements**
- Safety improvements, including lighting, fencing, video surveillance cameras
- Access control systems for elementary and middle schools.
- Reduction of the dependency on portable classrooms.
- Technology brought into the classroom.
- All bond debt paid off, making Cobb County one of only a few school districts in Georgia that is free of long-term debt.
- More than 5,600 total projects completed (or in progress) as promised to voters - all completed in a timely fashion with a net savings of millions of dollars for taxpayers due to efficient management.

SPLOST stands for **Special Purpose Local Option Sales Tax**. It is a one-cent tax on all consumer goods that must be approved by voters in a referendum. Education SPLOST (Ed-SPLOST) receipts can be used only for school-related capital improvements.

- The District's operating budget is not sufficient to fund capital improvements, or even regular building renovations and repairs. Approximately 90 percent of the District's operating budget pays salaries of teachers and other staff. The remaining portion covers daily operating expenses such as utilities, fuel, and supplies.
- Cobb is one of the only counties in Georgia that exempts all seniors 62 years and older from paying any school property tax.
- The District receives very little funding from the state that could be used for school building maintenance or technology.
- Before Ed-SPLOST, the school district issued bonds that were repaid from property tax revenues, or used ad valorem tax revenues to fund capital improvements. Both put the burden on property owners.
- Bonds must be repaid over many years with interest. SPLOST revenue is used as it is received-pay as you go. There is no interest to pay back.
- A \$221 million bond issued in 1995 for school construction was paid back with an additional \$92 million in interest.
- Those who do not pay property tax and/or live out of the county, but work and play in Cobb, support our schools by paying a significant portion of the Ed-SPLOST - estimates are 30 percent or more.
- By paying off all of the district's long-term debt, Ed-SPLOST has allowed the school board to eliminate the debt-service millage rate and lower the property tax rate.

CAPITAL PROJECT FUNDS ABOUT SPLOST

The graphic below represents total use, by post, of the Cobb School District Ed-SPLOST funds over the first five campaigns:

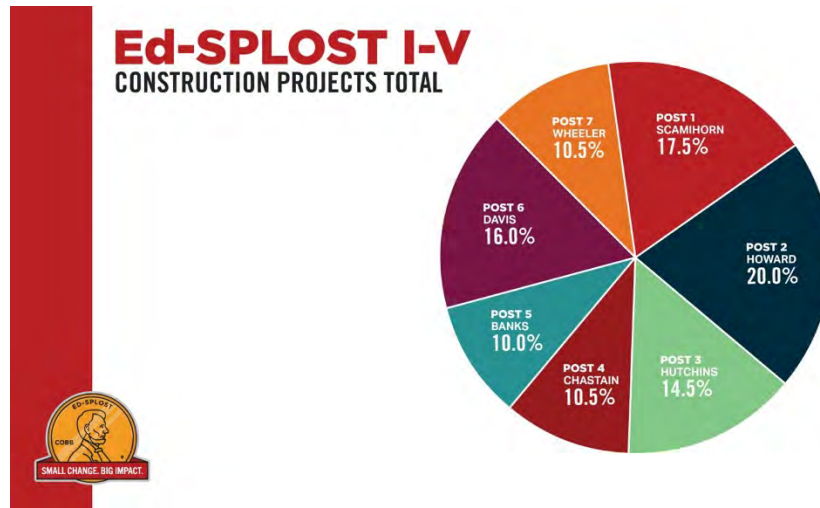

- Over the last several years, while the focus was on new classroom construction, many maintenance and infrastructure needs have developed in school buildings.
- With new growth projected for Cobb County, Ed-SPLOST V will focus on adding classrooms as well as continuing to focus on revitalizing the District's older schools and facilities.
- 32 percent of all Cobb County schools are

older than 40 years.

- Timely maintenance renovations today will prevent much more costly infrastructure emergencies in the future.
- An emphasis has been placed on student safety with a goal to enhance the security capabilities for every classroom in the District.



SPLOST 4 PROJECTS

On March 19, 2013, Cobb County citizens voted to approve another five-year 1% sales tax to improve our school system facilities and programs. Tax receipts were projected to be \$717,844,707 with additional funding from the State of Georgia. The tax became effective January 1, 2014, and expired on December 31, 2019. Projects include replacing five schools, building a Career Academy, school additions and modifications, renovations and maintenance; safety and support items such as school buses, textbooks, security fencing, access controls, surveillance cameras, furniture and equipment; and technology initiatives including audio visual equipment, interactive classrooms, district server replacement, copiers and printers, computing devices for teachers and other staff, network maintenance, phone system enhancement and music equipment.



Sope Creek ES PE Building Renovation

- **NEW/REPLACEMENT FACILITIES:** SPLOST 4 funds were used to replace Brumby ES, Mountain View ES, East Cobb MS, Osborne HS, Walton HS and to construct a new Cobb Innovation and Technology Academy. A total of \$266,004,703 has been expended on new/replacement facilities as of June 30, 2022.
- **LAND:** A total of \$10,026,846 has been spent for expenses relating to land acquisitions as of June 30, 2022.
- **ADDITIONS/MODIFICATIONS:** Major additions/modifications/renovations have been completed at the following schools: Campbell HS, Harrison HS, Lassiter HS, North Cobb HS, Pope HS, and South Cobb HS. A total of \$149,609,963 has been expended on additions and modifications as of June 30, 2022.
- **INFRASTRUCTURE/INDIVIDUAL SCHOOL NEEDS:** Projects include Athletic ADA/Individual school needs, sitework, HVAC replacement, lighting, flooring, and various mechanical and electrical upgrades. A total of \$58,355,802 has been expended on infrastructure and individual school needs as of June 30, 2022.
- **SAFETY AND SUPPORT IMPROVEMENTS:** School safety improvements continue with access controls, security fencing, signage, traffic improvements, and surveillance cameras. Support improvements include buses, vehicles and equipment, school level furniture and equipment for growth and replacement, food service upgrades, learning commons modifications and textbooks for students. A total of \$87,209,327 has been expended on safety and support improvements as of June 30, 2022.
- **CURRICULUM, INSTRUCTION AND TECHNOLOGY INITIATIVES:** Funds were used to maintain the existing technology infrastructure, as well as data center equipment, phone systems, network maintenance, computing devices, interactive classroom devices, printers, and copiers. Funding continues to provide equipment and software enhancements for existing programs such as special education and purchase musical instruments and equipment. A total of \$131,857,040 has been expended on curriculum, instruction and technology initiatives as of June 30, 2022.

SPLOST 4 REVENUES

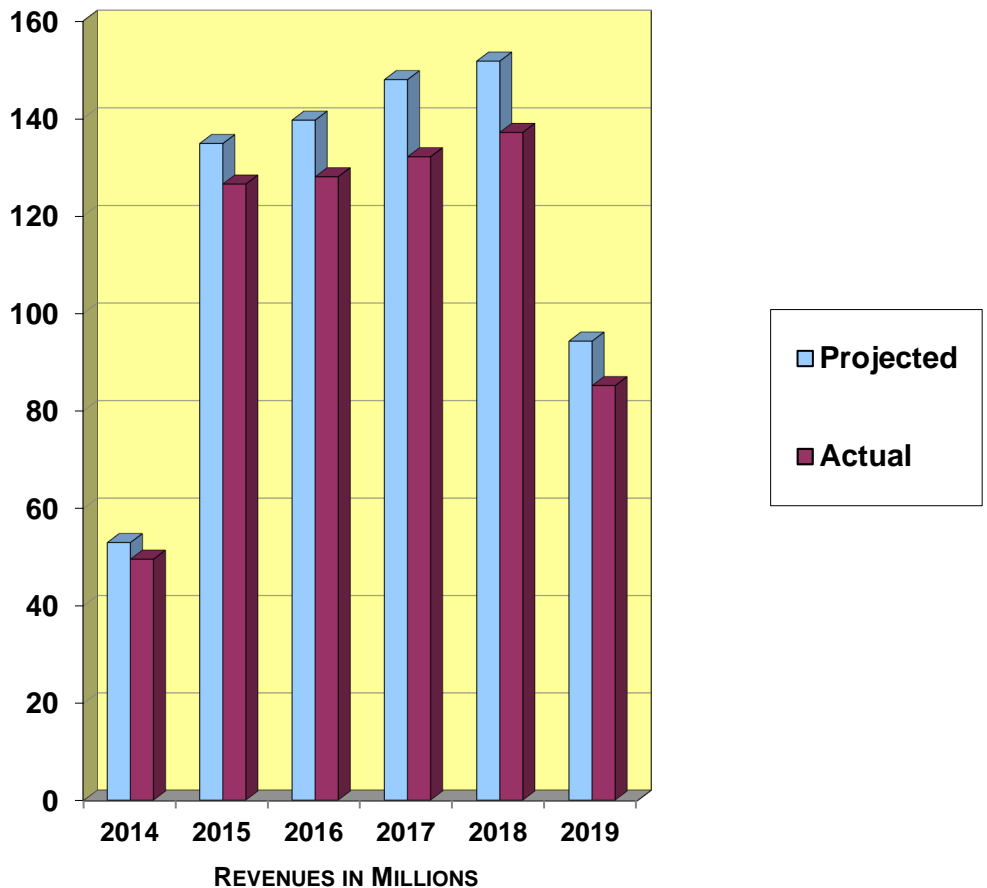

SPLOST REVENUES BY FISCAL YEAR				
YEAR	PROJECTED	ACTUAL	OVER / UNDER	% CHANGE
			BUDGET	
FISCAL YEAR 2014	\$52,890,320	\$49,460,990	-\$3,429,330	-6.5%
FISCAL YEAR 2015	\$134,729,710	\$126,374,557	-\$8,355,153	-6.2%
FISCAL YEAR 2016	\$139,450,724	\$128,643,843	-\$10,806,881	-7.7%
FISCAL YEAR 2017	\$145,028,746	\$132,004,692	-\$13,024,054	-9.0%
FISCAL YEAR 2018	\$151,564,436	\$137,072,655	-\$14,491,781	-9.6%
FISCAL YEAR 2019	\$94,180,771	85,085,443	-\$9,095,328	-9.7%
TOTALS	\$717,844,707	\$658,642,180	-\$59,202,527	-8.2%

SPLOST 4 sales tax collections began January 1, 2014, with the first revenues received in February 2014. The tax expired on December 31, 2018 with the last revenues received in January 2019.
 NOTE: The actual revenue figures do not include accruals.

SPLOST 4 EXPENDITURES BY CATEGORY

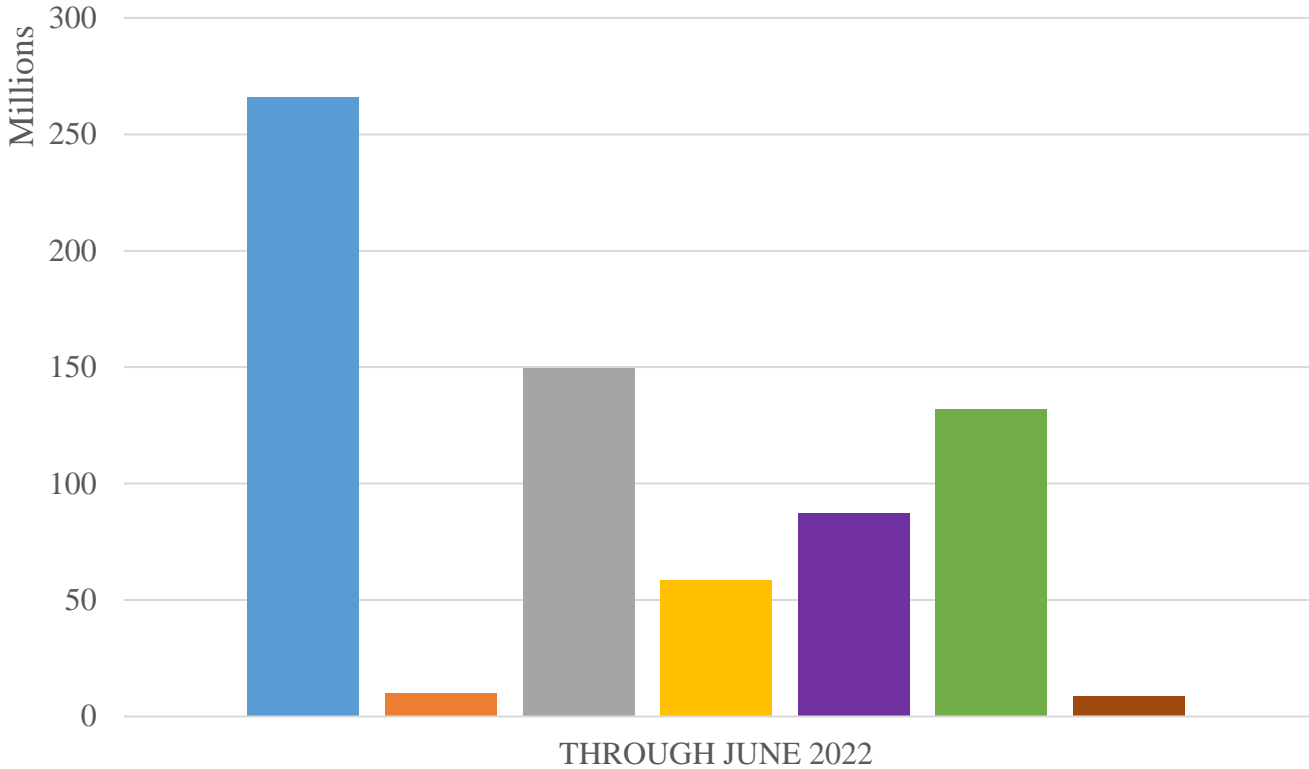

- New/Replacement Facilities
- Land
- Additions/Modifications
- Infrastructure/Individual School Needs
- Safety and Support
- Curriculum/Instructional/Technology
- Program Management

SPLOST 5 PROJECTS

On March 21, 2017, Cobb County citizens voted to approve another five year 1% sales tax to improve our school system facilities and programs. Tax receipts are projected to be \$797,022,000 with additional funding from the State of Georgia. The tax became effective January 1, 2019 and will expire on December 31, 2023. Projects include new and replacement facilities, additions and modifications to existing facilities, infrastructure and individual school needs, safety, security and support improvements, and academic and technology initiatives.



Osborne High School Performing Arts Center

- **NEW/REPLACEMENT FACILITIES:** SPLOST 5 funds will be used to replace three elementary schools and add a Smyrna area middle school. A total of \$132,885,657 has been expended on elementary replacement facilities and the new Smyrna area middle school as of June 30, 2022.
- **ADDITIONS/MODIFICATIONS:** Major additions/modifications/renovations are planned at the following locations: Campbell HS, Dickerson MS, Dodgen MS, Hillgrove HS, Lassiter HS, Lovinggood MS, North Cobb HS, Osborne HS, Pebblebrook HS, South Cobb HS, Sprayberry HS, Walton HS, Wheeler HS, and the Central Office Instructional Support Center. A total of \$142,458,879 has been expended on Additions/Modifications as of June 30, 2022.
- **INFRASTRUCTURE/INDIVIDUAL SCHOOL NEEDS:** Funds will be used for site work including high school turf replacement, thermal and moisture protection, doors, windows, hardware, finishes, specialties, mechanical conveying systems, toilet room renovation and electrical upgrades. A total of \$44,877,843 has been expended on Infrastructure/Individual School Needs as of June 30, 2022.
- **SAFETY, SECURITY, AND SUPPORT:** School safety improvements include buses, vehicles, and equipment, communication equipment for schools and public safety, computer aided dispatch equipment, food and nutritional services needs, growth and replacement of furniture, equipment, and finishes, land acquisitions, records management needs, safety and security, signage, and traffic control, school security-exterior and interior, surveillance cameras, transportation infrastructure, program administration, undesignated classrooms and warehouse needs. A total of \$41,241,245 has been expended on Safety, Security and Support as of June 30, 2022.
- **ACADEMIC/TECHNOLOGY INITIATIVES:** Funds are being used for data center equipment replacement, district network maintenance, district phone replacement, learning management system, learning resources, obsolete computing device replacement for teachers and obsolete interactive classroom devices replacement. In addition, funds will be used to maintain existing technology, provide equipment and software for students with disabilities, maintain and modify spaces for learning commons, fine arts, robotics and other learning spaces. A total of \$117,171,230 has been expended on Academic/Technology as of June 30, 2022.

SPLOST 5 REVENUES

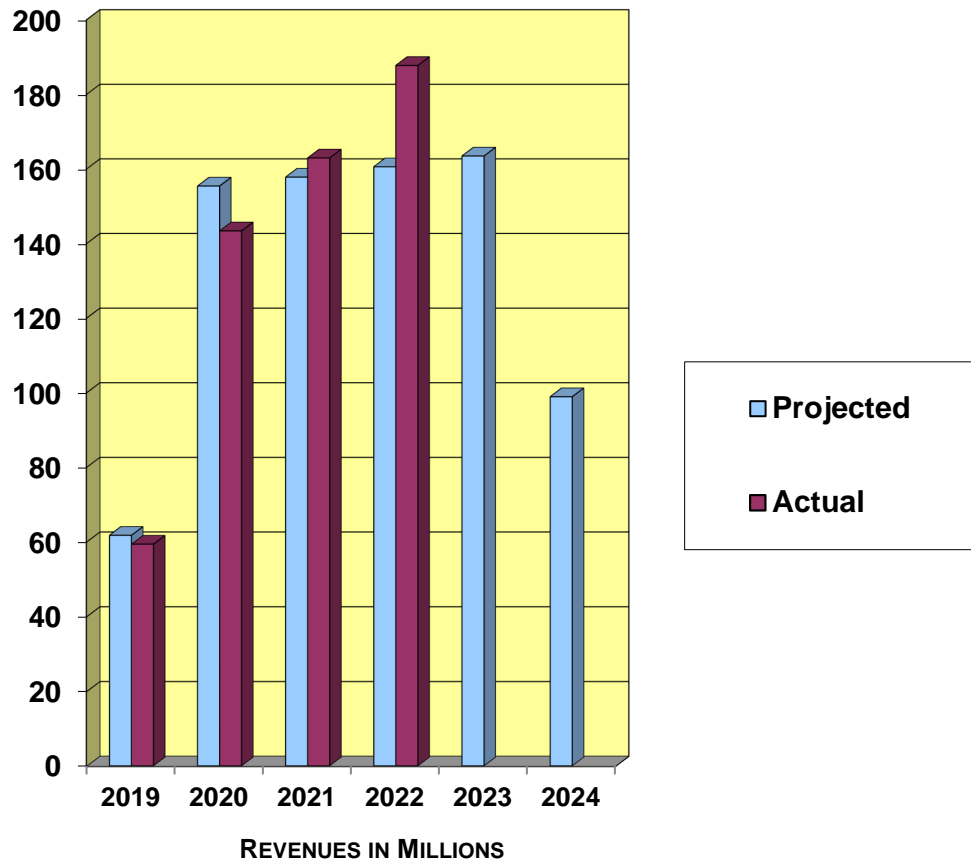

SPLOST REVENUES BY FISCAL YEAR				
YEAR	PROJECTED	ACTUAL	OVER / UNDER BUDGET	% CHANGE
FISCAL YEAR 2019	\$61,632,616	\$59,284,562	-\$2,348,054	-3.8%
FISCAL YEAR 2020	\$155,248,210	\$143,241,932	-\$12,006,278	-7.7%
FISCAL YEAR 2021	\$157,637,092	\$162,777,941	\$5,140,849	3.3%
FISCAL YEAR 2022	\$160,416,655	\$187,579,455	\$27,162,800	16.9%
FISCAL YEAR 2023	\$163,303,454			
FISCAL YEAR 2024	\$98,783,973			
TOTALS	\$797,022,000	\$552,883,890	-\$244,138,110	-30.6%

SPLOST 5 sales tax collections began January 1, 2019, with the first revenues received in February 2019. Revenue collections are expected to be \$797,022,000 for the period 2019 through 2024. NOTE: The actual revenue figures do not include accruals.

SPLOST 5 EXPENDITURES BY CATEGORY

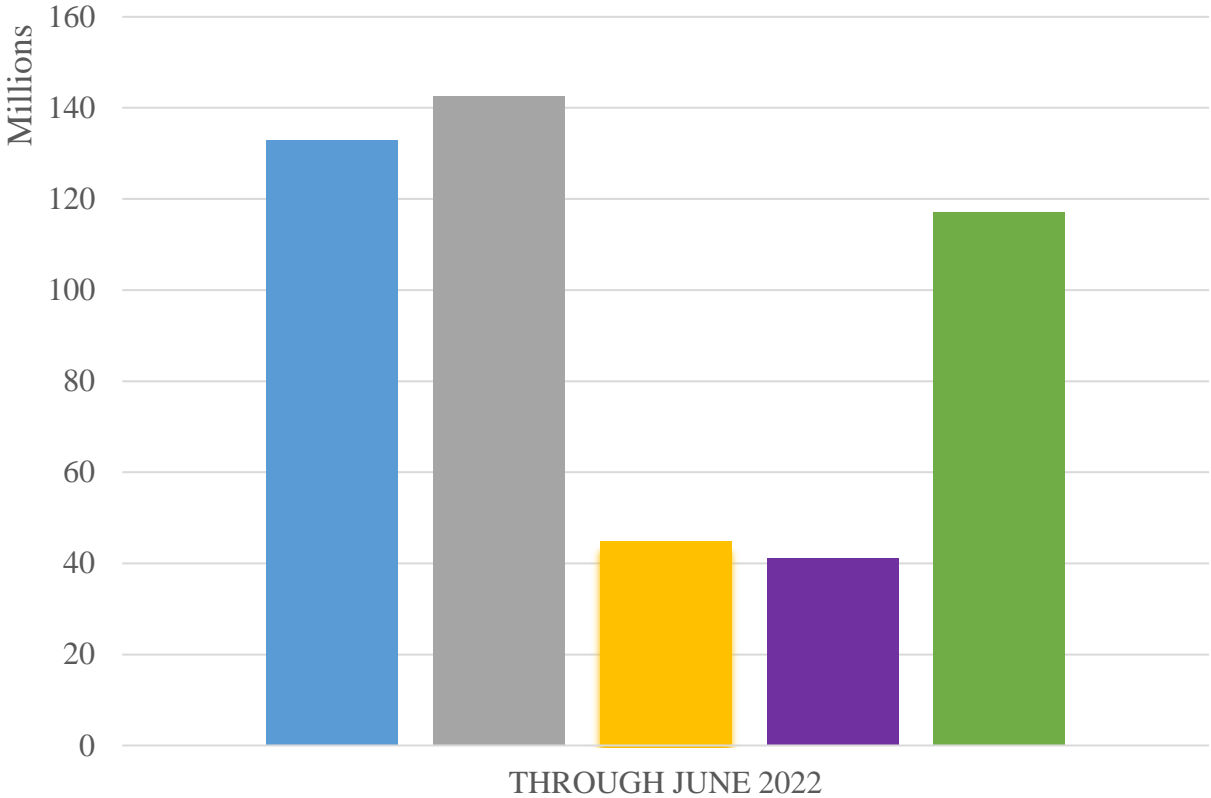

- New/Replacement Facilities
- Additions/Modifications
- Infrastructure/Individual School Needs
- Safety, Security & Support
- Academic/Technology

District Building Fund

The District Building Fund is a multi-year capital outlay fund used to track donations for small capital improvements and transfers from other funds for facility needs. Revenues also include interest income. Expenditures in the District Building Fund include portable classroom building expenses, land acquisitions, school improvement projects funded by donations, consultants for assessment of special district needs and long term facility planning, and small construction projects of an emergency nature that are not related to specific SPLOST funding. The current District Building Fund was established in FY2019.



Internal Service Fund and Other Fund

INTERNAL SERVICE FUND BUDGET

Internal Service Funds are used to account for the financing of goods or services provided by one department or agency to other departments or agencies of the governmental unit, or to other governmental units, on a cost reimbursement basis. The District has two individual funds in the Internal Service Funds category. The Unemployment Compensation and Self-Insurance Funds are used to account for the District's self-insurance programs.

OTHER SERVICE FUND BUDGET

The District has one fund in the Other Service Fund category. Catered Food Services provides catering services by school nutrition staff for schools and school-related organizations.

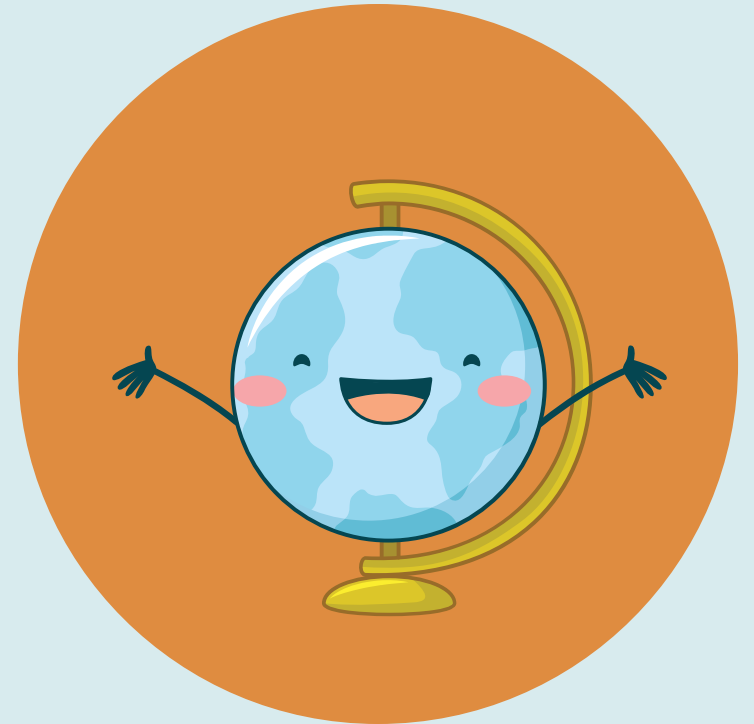

**INTERNAL SERVICE AND OTHER SERVICE FUNDS BUDGET
REVENUE AND APPROPRIATIONS (FUNCTION)
EIGHT YEAR COMPARISON**

Description	FY2019 Actual	FY2020 Actual	FY2021 Actual	FY2022 Revised Budget	FY2023 Approved Budget	FY2024 Forecast	FY2025 Forecast	FY2026 Forecast
Beginning Fund Balance July 1 (Estimated)	\$10,070,244	\$11,105,836	\$5,497,394	\$6,910,088	\$7,641,842	\$7,641,842	\$7,641,842	\$7,641,842
Revenue:								
Local	\$8,479,916	\$9,201,767	\$7,924,671	\$6,520,765	\$6,474,765	\$6,571,526	\$6,669,739	\$6,769,425
State		\$0	\$0	\$0	\$0	\$0	\$0	\$0
Federal		\$0	\$0	\$0	\$0	\$0	\$0	\$0
Transfers/Other	\$372,817	\$0	\$165,000	\$0	\$0	\$0	\$0	\$0
Total Revenue	\$8,852,733	\$9,201,767	\$8,089,671	\$6,520,765	\$6,474,765	\$6,571,526	\$6,669,739	\$6,769,425
Total Revenue & Fund Balance	\$18,922,977	\$20,307,603	\$13,587,065	\$13,430,853	\$14,116,607	\$14,213,368	\$14,311,581	\$14,411,267
Appropriations								
Instruction	\$0	\$0	\$0	\$0	\$0	\$0	\$0	\$0
Pupil Support Services	\$0	\$0	\$0	\$0	\$0	\$0	\$0	\$0
Improvement of Instr Svcs	\$0	\$0	\$0	\$0	\$0	\$0	\$0	\$0
Educational Media Services	\$0	\$0	\$0	\$0	\$0	\$0	\$0	\$0
Instructional Staff Training	\$0	\$0	\$0	\$0	\$0	\$0	\$0	\$0
Federal Grant Administration	\$0	\$0	\$0	\$0	\$0	\$0	\$0	\$0
General Administration	\$3,626	\$535	\$939	\$0	\$0	\$0	\$0	\$0
School Administration	\$0	\$0	\$0	\$0	\$0	\$0	\$0	\$0
Support Services-Business	\$7,778,247	\$7,354,172	\$6,710,428	\$7,504,189	\$6,450,765	\$6,547,526	\$6,645,739	\$6,745,425
Maint. & Oper of Plant Svcs	\$0	\$0	\$0	\$0	\$0	\$0	\$0	\$0
Student Transportation	\$0	\$0	\$0	\$0	\$0	\$0	\$0	\$0
Support Services - Central	\$0	\$0	\$0	\$0	\$0	\$0	\$0	\$0
Other Support Services	\$0	\$0	\$0	\$0	\$0	\$0	\$0	\$0
School Nutrition Program	\$35,268	\$0	\$0	\$0	\$0	\$0	\$0	\$0
Enterprise Operations	\$0	\$5,212	\$9,717	\$70,000	\$24,000	\$24,000	\$24,000	\$24,000
Community Services	\$0	\$0	\$0	\$0	\$0	\$0	\$0	\$0
Capital Outlay	\$0	\$0	\$0	\$0	\$0	\$0	\$0	\$0
Transfers	\$0	\$0	\$0	\$0	\$0	\$0	\$0	\$0
Debt Service	\$0	\$0	\$0	\$0	\$0	\$0	\$0	\$0
Total Appropriations	\$7,817,141	\$7,359,919	\$6,721,084	\$7,574,189	\$6,474,765	\$6,571,526	\$6,669,739	\$6,769,425
Ending Fund Balance June 30 (Estimated with Actuarial adjustment)	\$11,105,836	\$12,947,684	\$6,865,981	\$5,856,664	\$7,641,842	\$7,641,842	\$7,641,842	\$7,641,842
Total Expenditures & Fund Balance	\$18,922,977	\$12,857,313	\$13,587,065	\$13,430,853	\$14,116,607	\$14,213,368	\$14,311,581	\$14,411,267

Note: The grant fund budget of FY2024, FY2025, FY2026 are projected to reflect a salary step increase each year.

Note: The beginning fund balance of FY2021 reflected the exclusion of Actuarial outstanding losses reservation \$7.4 M in Fund 692.

Note: In FY2022 Purchasing/Warehouse Fund (Fund 0696) and Flexible Benefit Fund (Fund 697) balances moved to General Fund.

**INTERNAL SERVICE AND OTHER SERVICE FUNDS
REVENUE AND APPROPRIATIONS (OBJECT)
EIGHT YEAR COMPARISON**

	FY2019	FY2020	FY2021	FY2022	FY2023	FY2024	FY2025	FY2026
Description	Actual	Actual	Actual	Revised Budget	Approved Budget	Forecast	Forecast	Forecast
Beginning Fund Balance July 1 (Estimated)	\$10,070,244	\$11,105,836	\$5,497,394	\$6,910,088	\$7,641,842	\$7,641,842	\$7,641,842	\$7,641,842
Revenue:								
Local	\$8,479,916	\$9,201,767	\$7,924,671	\$6,520,765	\$6,474,765	\$6,571,526	\$6,669,739	\$6,769,425
State Revenue		\$0	\$0	\$0	\$0	\$0	\$0	\$0
Federal Revenue		\$0	\$0	\$0	\$0	\$0	\$0	\$0
Transfer In	\$372,817	\$0	\$165,000	\$0	\$0	\$0	\$0	\$0
Total Revenue	\$8,852,733	\$9,201,767	\$8,089,671	\$6,520,765	\$6,474,765	\$6,571,526	\$6,669,739	\$6,769,425
Total Revenue & Fund Balance	\$18,922,977	\$20,307,603	\$13,587,065	\$13,430,853	\$14,116,607	\$14,213,368	\$14,311,581	\$14,411,267
Appropriations								
51 Salaries	\$447,071	\$437,050	\$405,160	\$620,721	\$620,721	\$688,453	\$757,202	\$826,981
52 Employee Benefits	\$240,312	\$230,103	\$192,541	\$162,909	\$162,909	\$191,938	\$221,402	\$251,309
53 Contract Services	\$60,424	\$44,599	\$16,642	\$0	\$0	\$0	\$0	\$0
54 Repair and Rental w Water	\$17,502	\$3,850	\$3,745	\$70,000	\$70,000	\$70,000	\$70,000	\$70,000
55 Other Purchases w Telephone	\$6,357,857	\$6,136,743	\$5,316,303	\$5,503,085	\$4,503,085	\$4,503,085	\$4,503,085	\$4,503,085
56 Supplies and Equipments w Utiliti	\$158,181	\$92,895	\$341,697	\$293,600	\$194,176	\$194,176	\$194,176	\$194,176
58 Dues and Other Fees	\$385,708	\$389,602	\$352,672	\$889,104	\$889,104	\$889,104	\$889,104	\$889,104
59 Transfers	\$0	\$0	\$0	\$0	\$0	\$0	\$0	\$0
66 Fixed Assets Equipt	\$39,763	\$25,078	\$92,324	\$34,770	\$34,770	\$34,770	\$34,770	\$34,770
67 Fixed Assets CIP w Bldgs/Land	\$110,324	\$0	\$0	\$0	\$0	\$0	\$0	\$0
68 Other	\$0	\$0	\$0	\$0	\$0	\$0	\$0	\$0
Total Appropriations	\$7,817,141	\$7,359,919	\$6,721,084	\$7,574,189	\$6,474,765	\$6,571,526	\$6,669,739	\$6,769,425
Ending Fund Balance June 30 (Estimated with Actuarial adjustment)	\$11,105,836	\$12,947,684	\$6,865,981	\$5,856,664	\$7,641,842	\$7,641,842	\$7,641,842	\$7,641,842
Total Expenditures & Fund Balance	\$18,922,977	\$12,857,313	\$13,587,065	\$13,430,853	\$14,116,607	\$14,213,368	\$14,311,581	\$14,411,267

Note: The grant fund budget of FY2024, FY2025, FY2026 are projected to reflect a salary step increase each year.

Note: The beginning fund balance of FY2021 reflected the exclusion of Actuarial outstanding losses reservation \$7.4 M in Fund 692.

Note: In FY2022 Purchasing/Warehouse Fund (Fund 0696) and Flexible Benefit Fund (Fund 697) balances moved to General Fund.

**INTERNAL SERVICE AND OTHER SERVICE FUNDS
FIVE YEAR TREND OF FUND BALANCE**

\$ Millions

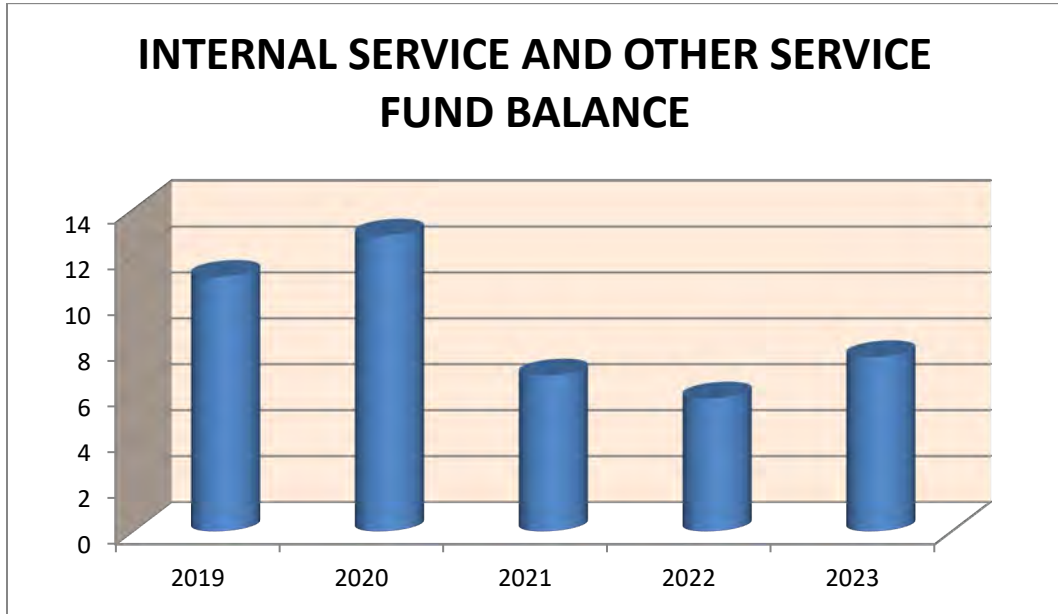

**INTERNAL SERVICE AND OTHER SERVICE FUNDS
FUND DESCRIPTIONS**

FUND #	FUND NAME	INTERNAL SERVICE FUND DESCRIPTION	REVENUE SOURCES
691	Unemployment	Employer contributions to Georgia Unemployment Compensation Fund are used to pay Unemployment Benefits. This fund accounts for the cost of compensation for unemployment for previous employees that separated involuntary	Unemployment rates are determined by employer experience. Lower rates are earned by employers whose unemployment experience costs are less, and higher rates are assigned to employers whose experience indicates greater cost
692	Self-Insurance	The Board of Education provides the total cost of a worker's compensation program that pays for employee claims for injuries resulting from performance of their duties. This fund also provides insurance for General Liability and Auto	Workers Compensation revenue is developed based on past and current claims history. General Liability and Auto revenue is based on past and current year insurance payments
FUND #	FUND NAME	OTHER SERVICE FUND DESCRIPTION	REVENUE SOURCES
693	Catered Food Services	This fund was established to self-supporting catering services performed by FNS staff for schools and school related organizations	The revenues generated from the enterprise operations

INTERNAL SERVICE AND OTHER SERVICE FUNDS
SUMMARY OF INTERNAL SERVICE AND OTHER SERVICE FUNDS
FY2023 BUDGET

Description	Fund 691	Fund 692	Fund 693	Total
	Unemployment	Self-Insurance	Catered Food Services	
Beginning Fund Balance				
July 1 (Estimated)	\$72,825	\$7,541,551	\$27,466	\$7,641,842
Revenue:				
Local	\$300,000	\$6,150,765	\$24,000	\$6,474,765
State Revenue	\$0	\$0	\$0	\$0
Federal Revenue	\$0	\$0	\$0	\$0
Transfer In	\$0	\$0	\$0	\$0
Total Revenue	\$300,000	\$6,150,765	\$24,000	\$6,474,765
Appropriations				
Instruction	\$0	\$0	\$0	\$0
Pupil Support Services	\$0	\$0	\$0	\$0
Improvement of Instr Svcs	\$0	\$0	\$0	\$0
Educational Media Services	\$0	\$0	\$0	\$0
Instructional Staff Training	\$0	\$0	\$0	\$0
Federal Grant Administration	\$0	\$0	\$0	\$0
General Administration	\$0	\$0	\$0	\$0
School Administration	\$0	\$0	\$0	\$0
Support Services-Business	\$300,000	\$6,150,765	\$0	\$6,450,765
Maint. & Oper of Plant Svcs	\$0	\$0	\$0	\$0
Student Transportation	\$0	\$0	\$0	\$0
Support Services - Central	\$0	\$0	\$0	\$0
Other Support Services	\$0	\$0	\$0	\$0
School Nutrition Program	\$0	\$0	\$0	\$0
Enterprise Operations	\$0	\$0	\$24,000	\$24,000
Community Services	\$0	\$0	\$0	\$0
Capital Outlay	\$0	\$0	\$0	\$0
Transfers	\$0	\$0	\$0	\$0
Debt Service	\$0	\$0	\$0	\$0
Total Appropriations	\$300,000	\$6,150,765	\$24,000	\$6,474,765
Ending Fund Balance				
June 30 (Estimated)	\$72,825	\$7,541,551	\$27,466	\$7,641,842

Information Section

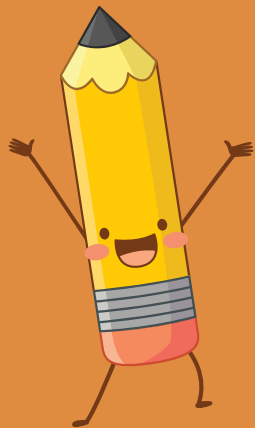

**COBB COUNTY SCHOOL DISTRICT
MILLAGE RATE AND PROPERTY TAX CALCULATION**

Metro Atlanta Millage Rate Comparison

Metro Atlanta System	General Fund Millage	Bond Millage	Total Millage	Standard Homestead Exemption
Atlanta (APS)	20.740	0.000	20.740	\$50,000
Cobb	18.900	0.000	18.900	\$10,000
Dekalb	23.080	0.000	23.080	\$12,500
Fulton	17.796	0.000	17.796	\$2,000
Gwinnett	19.700	1.650	19.700	\$4,000

Based on FY2022 (2021 Digest) millage rates adopted by Metro Atlanta school districts.

Property Tax Rates – Cobb County School District

Note: Taxes are levied on real and personal property. Based on a millage levy of 1.00 Mill, a homeowner would pay \$1.00 per \$1,000 on 40% of the assessed value.

Fiscal Year	General Fund Millage Rate	Bond Fund Millage Rate	Total Millage Rate
2014	18.90	0.00	18.90
2015	18.90	0.00	18.90
2016	18.90	0.00	18.90
2017	18.90	0.00	18.90
2018	18.90	0.00	18.90
2019	18.90	0.00	18.90
2020	18.90	0.00	18.90
2021	18.90	0.00	18.90
2022	18.90	0.00	18.90
2023	18.90	0.00	18.90



How the Tax Rate is used to calculate a tax bill on Assessed Value?

An example of how FY2023 County School Taxes are calculated for a \$325,000 home:

<u>Calculation</u>	<u>Item</u>
\$325,000	House assessed at Fair Market Value
X .40	40% Assessment Rate
<hr/> \$130,000	Assessed Value for Tax Purposes
(\$10,000)	Homestead Exemption
<hr/> \$120,000	Tax Base for Property Tax
X .0189	<u>Millage Rate 18.90</u>
<hr/> \$ 2,268	General Fund School Taxes

EQDD'EQWPV| 'UEJ QQN'FKVTEV

O KNCI G'TCVG'CPF'RTQRGTV| 'VCZ'ECNEWNCVKQP '*E qpvpwgf +



(amounts expressed in thousands)

Net M&O							
For Maintenance & Operations of Schools							
<u>Fiscal Year</u>	<u>Real Property</u>	<u>Personal Property</u>	<u>Public Services</u>	<u>Motor Vehicle</u>	<u>Total Assessed Value</u>	<u>Direct Rate</u>	<u>Estimated Actual Value</u>
2013	16,898,249	1,374,209	838,778	1,779,893	20,891,129	1.890%	52,227,822
2014	16,352,749	1,439,170	893,003	1,716,625	20,401,547	1.890%	51,003,931
2015	17,266,640	1,607,722	870,412	1,365,200	21,109,974	1.890%	52,774,935
2016	18,421,285	1,607,041	855,371	990,609	21,874,306	1.890%	54,685,822
2017	19,947,408	1,722,374	853,860	718,250	23,241,892	1.890%	58,104,731
2018	21,599,228	1,825,340	839,298	518,534	24,782,400	1.890%	61,956,001
2019	23,677,091	1,963,114	869,266	393,218	26,902,689	1.890%	67,256,723
2020	25,105,013	2,061,394	888,756	314,519	28,369,682	1.890%	70,924,205
2021	26,450,073	2,140,213	930,324	253,586	29,774,196	1.890%	74,435,489
2022	28,161,560	2,147,911	975,747	211,623	31,496,841	1.890%	78,742,102

Property Taxes - Assessments are based on 40% of the appraised market value as of January 1 each year.

Source: Office of Tax Commissioner, Cobb County

**COBB COUNTY SCHOOL DISTRICT
TAX RATE EFFECT ON THE AVERAGE TAXPAYER**

The Cobb County Tax Assessor provides the average estimated values for both Homestead and Non-Homestead real property.

Homestead property, which is usually a personal or primary residence, the average Cobb County taxpayer would pay approximately \$2,268 in school district taxes on a residence valued at \$325,000 in 2022. The chart below illustrates the recent changes in the Fair Market Value of Homestead Property in Cobb County and the resulting school district property tax.

Average Estimated Value for Homesteaded Property:					
	2018	2019	2020	2021	2022
					(Estimated)
	Actual	Actual	Actual	Actual	Projected
Fair Market Value Assessment	\$ 289,474	\$ 308,515	\$ 322,373	\$ 342,863	\$ 325,000
40% Assessed Rate	x 0.40	x 0.40	x 0.40	x 0.40	x 0.40
Assessed Value for Tax Purposes	\$ 115,790	\$ 123,406	\$ 128,949	\$ 137,145	\$ 130,000
Homestead Exemption	(10,000)	(10,000)	(10,000)	(10,000)	(10,000)
Tax Base for Property Tax	105,790	113,406	118,949	127,145	120,000
Millage Rate @ 18.90	x 0.01890	x 0.01890	x 0.01890	x 0.01890	x 0.01890
Property Tax	\$1,999.42	\$2,143.37	\$2,248.14	\$2,403.04	\$ 2,268.00

Non-Homestead Property represents industrial, commercial and some agricultural property and “second homes.” The average estimated value of Non-Homestead Property is typically higher than Homestead Property and provides a significant amount of tax revenue for the District. In 2022, the average taxpayer would pay approximately \$3,402 in school district taxes on Non-Homestead Property valued at \$450,000. The chart below illustrates the recent changes in the Fair Market Value of Non-Homestead Property in Cobb County and the resulting school district property tax.

Average Estimated Value for Non-Homesteaded Property:					
	2018	2019	2020	2021	2022
					(Estimated)
	Actual	Actual	Actual	Actual	Projected
Fair Market Value Assessment	\$ 407,539	\$ 429,845	\$ 451,467	\$ 489,078	\$ 450,000
40% Assessed Rate	x 0.40	x 0.40	x 0.40	x 0.40	x 0.40
Assessed Value for Tax Purposes	\$ 163,016	\$ 171,938	\$ 180,587	\$ 195,631	\$ 180,000
Homestead Exemption	-	-	-	-	-
Tax Base for Property Tax	163,016	171,938	180,587	195,631	180,000
Millage Rate @ 18.90	x 0.01890	x 0.01890	x 0.01890	x 0.01890	x 0.01890
Property Tax	\$3,080.99	\$3,249.63	\$3,413.09	\$3,697.43	\$ 3,402.00

COBB COUNTY SCHOOL DISTRICT DISTRICT STUDENT ENROLLMENT

In November of each year, enrollment projections for the forthcoming school year are made in collaboration with the District’s Accountability & Research Department and the Financial Planning & Analysis Department. These projections are used to prepare the proposed revenue and expenditure budget to ensure successful schools and educational programs. The methodology of forecasting is to review the historical trends in enrollment data at each grade level for each school. In addition, the projections took into consideration the **Enrollment Study Annual Update** that developed for the District by Educational Planners, LLC., (February 2022), as well as a review on the population and housing data of the Atlanta Regional Commission (ARC). The following table presents the past five years of active enrollment data (count in Full-Time Equivalents FTE basis) and a projection for future years:

Five Year History	FY2018	FY2019	FY2020	FY2021	FY2022
Enrollment	111,482	111,386	111,760	106,983	106,617
Growth Rate	-	(0.09%)	0.33%	(4.30%)	(0.34%)

Projection	FY2023	FY2024	FY2025	FY2026
Enrollment	106,732	107,799	108,877	109,966
Growth Rate	0.11%	1.00%	1.00%	1.00%



FY2023 PERSONNEL RESOURCE CHANGES – GENERAL FUND



(In FTE Basis)

GENERAL FUND	FY2019 Revised Budget	FY2020 Revised Budget	FY2021 Revised Budget	FY2022 Revised Budget	FY2023 Approved Budget
Instructional School Positions					
Kindergarten Teachers	355.00	348.00	360.00	299.00	325.00
Kindergarten Early Intervention Program	132.50	129.00	135.00	120.00	126.00
Grades 1-3	1,027.00	1,016.00	1,022.50	960.50	952.00
Grades 1-3 Early Intervention Program	277.00	286.50	295.00	312.00	302.00
Grades 4-5	589.00	581.00	581.00	553.00	537.00
Grades 4-5 Early Intervention Program	185.00	186.00	194.50	203.50	208.00
Elementary Specialists	229.50	229.00	228.00	218.00	219.00
Grades 6-8	835.00	850.00	864.50	839.50	810.50
Grades 9-12/Alternative Program	1,083.50	1,074.50	1,070.00	1,074.50	1,083.50
Virtual Learning Teachers	11.00	11.00	11.00	11.00	11.00
Career & Technology	117.50	115.00	121.50	133.00	131.50
ROTC	28.00	28.00	28.00	28.00	28.00
IEL Intensive English Language Teacher	32.50	31.50	31.50	27.00	27.00
In School Suspension Teacher	0.00	0.00	0.00	0.00	0.00
Discretionary Staff - Certified	59.11	163.11	31.11	283.61	107.11
Discretionary Staff - Certified	20.00	20.00	20.00	20.00	20.00
Magnet Coordinators & Teachers	18.00	18.00	18.00	18.00	18.00
English as a Second Language - ESOL	191.50	190.00	209.50	214.00	220.50
Gifted	541.00	547.00	563.50	580.00	559.00
Remedial Education Teachers	223.50	240.00	250.50	255.50	301.00
PBIS Positive Behavior Intervention	1.00	0.00	0.00	0.00	0.00
Special Ed - Teachers	1,255.00	1,255.00	1,300.00	1,300.00	1,300.00
Special Ed - Preschool Teachers	79.50	79.50	79.50	79.50	79.50
Special Ed - Parapros	452.00	452.00	452.00	452.00	452.00
Special Ed - Preschool Parapros	137.00	137.00	137.00	137.00	137.00
In School Suspension Parapros	41.00	41.00	41.00	42.00	42.00
Kindergarten Parapros	355.00	348.00	360.00	299.00	324.00
Other Instructional Parapros	230.60	228.10	228.10	213.20	233.00
Virtual Learning Parapros	16.00	16.00	16.00	16.00	17.00
Media Specialists	126.00	126.00	125.00	126.00	127.00
Discretionary Staffs - Classified	0.00	0.00	0.00	0.00	0.00
Total Instructional School Positions	8,648.71	8,746.21	8,773.71	8,814.81	8,697.61
Other School Support Positions					
Principals	109.00	109.00	108.00	109.00	109.00
Assistant Principals	229.00	228.00	229.00	224.00	219.00
Cobb Horizon Parent Facilitator	1.00	0.00	0.00	0.00	0.00
Program Director/Coordinator/Admin	1.00	2.00	2.00	4.00	6.00
Counselors (Elementary, Middle, High)	257.50	258.50	259.00	253.00	252.00
Local School Secretary	109.00	109.00	110.00	111.00	111.00

FY2023 PERSONNEL RESOURCE CHANGES – GENERAL FUND (Continued)



(In FTE Basis)

GENERAL FUND	FY2019 Revised Budget	FY2020 Revised Budget	FY2021 Revised Budget	FY2022 Revised Budget	FY2023 Approved Budget
Local School Bookkeeper	111.50	111.00	111.00	112.50	112.50
Local School Clerical	274.00	270.50	272.50	269.00	273.00
Interpreters – ESOL/ Foreign Language	12.00	12.00	12.00	12.00	12.00
Parent Resource Specialist at IWC	0.00	0.00	0.00	8.00	8.00
Interpreters – Special Ed	7.00	7.00	7.00	7.00	7.00
Diagnosticians	4.00	4.00	4.00	4.00	4.00
Diagnosticians - Preschool	4.00	4.00	4.00	4.00	4.00
Audiologists	3.30	3.30	3.30	3.30	3.30
Occupational Therapists	9.30	9.30	9.30	9.30	9.30
Physical Therapists	6.40	6.40	6.40	6.40	6.40
Speech Language Pathologist (SLP)	191.00	191.00	191.00	191.00	191.00
SLP Parapros	4.00	4.00	4.00	4.00	4.00
Special Ed Nurses	12.38	12.50	12.50	12.50	12.50
SpEd School Based Leadership AP	85.00	85.00	85.00	85.00	85.00
School Nurses & Consulting Nurses	102.80	116.00	117.00	118.00	116.00
Hospital / Homebound	2.00	3.00	3.00	3.00	3.00
Special Ed Preschool Specialist	1.00	1.00	1.00	1.00	1.00
Tech Specialists – Tech Dept	71.00	71.00	71.00	73.00	73.00
Psychologists	40.25	40.25	40.25	40.25	50.25
Social Workers	33.00	33.00	33.00	33.00	33.00
Campus Officers	47.00	49.00	49.00	50.00	50.00
Custodians	592.85	600.35	617.35	623.85	628.85
Bus Monitors	60.00	60.00	60.00	60.00	60.00
Bus Drivers (Regular & Sp Ed)	849.00	849.00	859.00	859.00	859.00
Maintenance	139.00	139.00	139.00	139.00	139.00
Mechanics – Fleet Maintenance	49.00	49.00	49.00	49.00	49.00
Total Other School Support Positions	3,417.28	3,437.10	3,468.60	3,478.10	3,491.10
Central Office Support Positions					
Division 1 – General Administration	19.00	16.00	16.00	16.50	16.50
Division 2 – Operational Support	53.25	53.25	54.25	71.25	71.25
Division 2 – Human Resources	45.10	45.50	45.00	47.00	50.50
Division 3 – Technology	60.50	59.50	58.50	58.50	60.00
Division 3 – Accountability & Research	35.50	36.50	36.50	37.50	42.50
Division 4 – Academics-Teach & Learn	66.78	66.78	66.78	66.78	66.78
Division 4 – Academics-Special Ed Svcs	19.00	24.00	26.00	26.00	26.00
Division 5 – Leadership	18.00	17.00	17.49	17.49	17.49
Division 6 – Financial Services	54.70	54.65	54.65	54.65	56.65
Total Central Office Support Positions	371.83	373.18	375.17	395.67	407.67
Grand Total – General Fund Positions	12,437.82	12,556.49	12,617.48	12,688.58	12,596.38

FY2023 PERSONNEL RESOURCE CHANGES – OTHER FUNDS



(In FTE Basis)

OTHER FUNDS	FY2019 Revised Budget	FY2020 Revised Budget	FY2021 Revised Budget	FY2022 Revised Budget	FY2023 Approved Budget
SPLOST 4	0.00	0.00	0.00	0.00	0.00
SPLOST 5	34.62	34.12	34.12	33.05	33.05
Title I	194.35	179.60	170.60	169.60	171.10
IDEA	310.90	333.40	322.60	312.00	312.00
CTAE	0.00	0.00	0.00	0.00	0.00
Title II - A	10.98	10.99	10.99	10.98	10.98
CARES Act Relief Fund	0.00	0.00	0.00	0.00	0.00
Homeless Grant	0.00	0.00	0.00	0.00	0.00
American Rescue Plan Act	0.00	0.00	0.00	215.00	215.00
Federal Funded Grants	0.00	0.00	0.00	0.00	0.00
Title III – A (LEP)	7.20	7.50	6.05	6.05	6.05
Title IV – A & B	1.00	2.50	3.40	3.36	3.36
Adult Education	7.00	7.00	7.00	7.00	7.00
GNETS	56.35	46.25	46.25	38.25	38.25
Venue Management	2.00	2.00	2.00	4.00	0.00
After School Program	4.10	4.10	4.10	4.10	4.10
Tuition School	1.00	1.00	1.00	1.00	1.00
Public Safety	21.00	21.00	21.00	21.00	21.00
Adult High School	2.60	2.60	2.60	2.60	2.60
Pre-Kindergarten (Lottery)	1.38	1.00	1.00	6.00	8.00
School Nutrition Service	1,218.00	1,216.00	1,216.00	1,216.00	1,216.00
Self-Insurance	5.00	5.00	5.00	5.69	5.69
Purchasing	15.90	15.90	17.00	0.00	0.00
Flexible Benefits	1.00	1.00	1.00	0.00	0.00
Grand Total – Other Funds Positions	1,894.38	1,890.96	1,871.71	2,055.68	2,055.18

The District FY2023 Personnel total 14,651.56 (in FTE basis) including General Fund and Other Funds positions.



**COBB COUNTY SCHOOL DISTRICT
FIVE YEARS GENERAL FUND FORECAST**

Type	Category	FY2022 Board Approved Revised Budget	FY2023	FY2024	FY2025	FY2026	FY2027	FY2028	Assumptions														
1 Local	Property Tax Revenue	\$564,026,799	\$629,045,845	\$660,498,137	\$693,523,044	\$728,199,196	\$764,609,156	\$802,839,614	<table border="1"> <tr> <td colspan="2"><u>Property Digest Information</u></td> </tr> <tr> <td>FY2023 Projected Digest</td> <td align="right">10.49%</td> </tr> <tr> <td>FY2024 Projected Digest</td> <td align="right">5.00%</td> </tr> <tr> <td>FY2025 Projected Digest</td> <td align="right">5.00%</td> </tr> <tr> <td>FY2026 Projected Digest</td> <td align="right">5.00%</td> </tr> <tr> <td>FY2027 Projected Digest</td> <td align="right">5.00%</td> </tr> <tr> <td>FY2028 Projected Digest</td> <td align="right">5.00%</td> </tr> </table>	<u>Property Digest Information</u>		FY2023 Projected Digest	10.49%	FY2024 Projected Digest	5.00%	FY2025 Projected Digest	5.00%	FY2026 Projected Digest	5.00%	FY2027 Projected Digest	5.00%	FY2028 Projected Digest	5.00%
<u>Property Digest Information</u>																							
FY2023 Projected Digest	10.49%																						
FY2024 Projected Digest	5.00%																						
FY2025 Projected Digest	5.00%																						
FY2026 Projected Digest	5.00%																						
FY2027 Projected Digest	5.00%																						
FY2028 Projected Digest	5.00%																						
2	Other Tax Revenue	\$66,872,353	\$77,043,779	\$77,043,779	\$77,043,779	\$77,043,779	\$77,043,779	\$77,043,779	Constant														
3	Other Local	\$4,578,960	\$4,515,173	\$4,515,173	\$4,515,173	\$4,515,173	\$4,515,173	\$4,515,173	Constant														
4 State	Miscellaneous State Grant	\$6,208,120	\$5,599,461	\$5,599,461	\$5,599,461	\$5,599,461	\$5,599,461	\$5,599,461	Constant														
5	QBE	\$535,357,204	\$578,512,537	\$578,512,537	\$578,512,537	\$578,512,537	\$578,512,537	\$578,512,537	Constant														
6 Federal	Indirect Cost	\$4,006,460	\$5,606,481	\$4,517,147	\$4,517,147	\$4,517,147	\$4,517,147	\$4,517,147	Constant														
7	ROTC	\$1,204,272	\$1,239,971	\$1,072,281	\$1,072,281	\$1,072,281	\$1,072,281	\$1,072,281	Constant														
8	MedAce	\$1,117,141	\$1,138,479	\$985,295	\$985,295	\$985,295	\$985,295	\$985,295	Constant														
9	Medicaid	\$689,545	\$707,716	\$557,630	\$557,630	\$557,630	\$557,630	\$557,630	Constant														
10	Revenue Total	\$1,184,060,854	\$1,303,409,442	\$1,333,301,440	\$1,366,326,347	\$1,401,002,499	\$1,437,412,459	\$1,475,642,917															
11	Reserve Available	\$71,687,571	\$29,851,087	\$-	\$-	\$-	\$-	\$-															
	Total Funds Available	\$1,255,748,425	\$1,333,260,529	\$1,333,301,440	\$1,366,326,347	\$1,401,002,499	\$1,437,412,459	\$1,475,642,917															
12	Base	FY22 Revised Budget	\$1,255,748,425																				
13		FY23 Proposed Budget	\$1,333,260,529																				
14		Prior Year Continuation Budget		\$1,333,260,529	\$1,348,786,065	\$1,364,521,984	\$1,380,971,442	\$1,398,137,641															
15	Salary/Benefits	Annual Step Increase		\$14,025,536	\$14,235,919	\$14,449,458	\$14,666,200	\$14,886,193	Annual Step Increase for All Eligible Employees Estimated based on historical trends														
16		Increased Benefit Cost		\$1,500,000	\$1,500,000	\$2,000,000	\$2,500,000	\$3,000,000															
12	Base	FY22 Loan to SPLOST6	\$3,464,951																				
	Expenditure Total	\$1,259,213,376	\$1,333,260,529	\$1,348,786,065	\$1,364,521,984	\$1,380,971,442	\$1,398,137,642	\$1,416,023,834															
	Forecasted (Deficit)/Surplus	(\$3,464,951)	\$-	(\$15,484,625)	\$1,804,363	\$20,031,058	\$39,274,818	\$59,619,083															

Conservative Budget Practices – Cobb County School District utilizes realistic, but conservative, budgeting practices when developing the annual budget, in both Revenue and Expenditure estimates. Regarding revenues, these estimates could include budgeting the lower amount of a given range of estimated receipts or being cautiously optimistic about the amount of revenues to be received from a given source, among other factors. For expenditures, these assumptions could include budgeting for all positions to be filled for the full year, assuming all new employees will elect health insurance coverage, and budgeting Teachers’ salaries at an average amount. Due to the conservative nature of CCSD’s budgeting practices, budgeted expenditures may exceed budgeted revenues in a given fiscal year, resulting in a forecasted usage of fund balance.

District & Student Performance

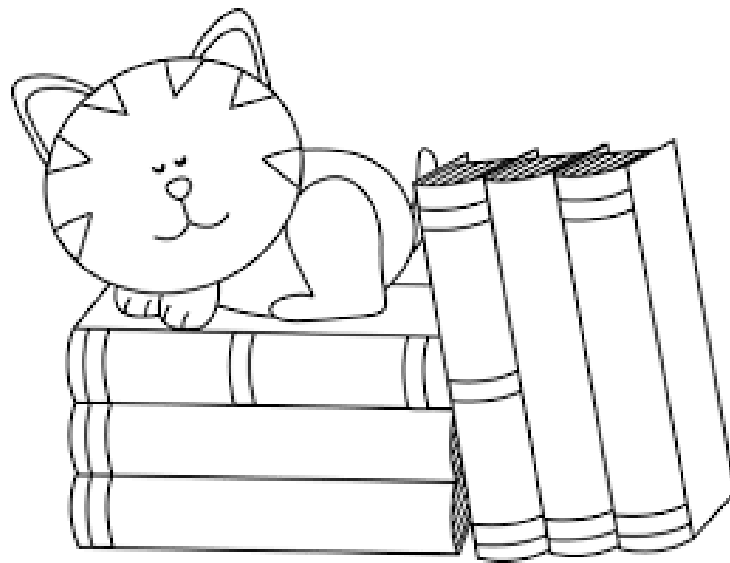

THE COBB COMMITMENT

COBB
TEACHING AND
LEARNING
STANDARDS

CLEARLY
ARTICULATED
LEARNING
STANDARDS



BALANCED **K-12** **BALANCED**
LITERACY **MATH**
INSTRUCTION **INSTRUCTION**

BALANCED
APPROACH TO
TEACHING &
LEARNING

LEARNING ENGAGEMENT
DEEPER LEARNING
STRATEGIES

INTENTIONAL
LEARNING
ENGAGEMENT



MONITORING
EVERY STUDENT'S
LEARNING
PROGRESS



TO
STUDENT SUCCESS!

SCHOOL DISTRICT AND STUDENT PERFORMANCE

GEORGIA NAMES 16 COBB HIGH SCHOOLS 2022 AP HONOR SCHOOLS



The Georgia Department of Education and State Superintendent Richard Woods recently announced the list of 2022 Advanced Placement (AP) Honor Schools, which includes all 16 traditional high schools in the Cobb County School District.

“We are committed to expanding opportunities for Georgia students, including in advanced and accelerated coursework,” Superintendent Woods said. “I offer my sincere congratulations to each of this year’s AP Honor Schools, and thank each teacher, student, and school leader who worked hard to create strong AP opportunities in these Georgia schools.”

Nine Cobb schools earned honors in five categories. One school took home honors in four categories, while other six high schools claimed honors in more than one category.

The 2022 Advanced Placement (AP) Honor School Categories are:

AP Access and Support Schools Schools with at least 30% of AP exams taken by students who identified themselves as African-American and/or Hispanic and 30% of all AP exams earning scores of 3 or higher.

AP Schools of Distinction Schools with at least 20% of the total student population taking AP exams and at least 50% of all AP exams earning scores of 3 or higher.

AP Humanities Schools Schools with a minimum of five students testing in each of the following AP categories: one ELA course, two history/social science courses, one fine arts course and one world language course.

AP Humanities Achievement Schools AP Humanities schools (see above definition) with at least 50% of all AP Humanities exams earning scores of 3 or higher.

SCHOOL DISTRICT AND STUDENT PERFORMANCE

GEORGIA NAMES 16 COBB HIGH SCHOOLS 2022 AP HONOR SCHOOLS (Continued)

AP STEM Schools Schools with a minimum of five students testing in at least four AP STEM courses. (AP Calculus AB, AP Calculus BC, AP Statistics, AP Biology, AP Chemistry, AP Environmental Science, AP Physics 1, AP Physics 2, AP Physics C, AP Computer Science A, AP Computer Science Principles)

AP STEM Achievement Schools AP STEM schools (see above definition) with at least 50% of all AP STEM exams earning scores of 3 or higher.



SCHOOL DISTRICT AND STUDENT PERFORMANCE

COBB SCHOOLS CELEBRATE GRADUATIONS FOR 8,000 STUDENTS, AND \$106 MILLION IN SCHOLARSHIPS



In May 2022, families, educators, and school communities are celebrating the graduation of about **8,137** Cobb students--more graduates than in 2021. The Cobb Schools Class of 2022 spent most of their high school career amid a global pandemic, but they persevered. They succeeded.

As they bid farewell to the teachers and schools who prepared them for their future academic pursuits and careers, they are doing so with more than **\$106 million in scholarship offers**. That is more than a \$6 million increase over the Class of 2021. Some of those scholarship offers for 2022 have flowed in from the University of Georgia, Harvard University, University of Alabama, Auburn University, Boston University, University of South Carolina, Mercer University, and more.

“Our Superintendent keeps our staff focused on helping every student. In Cobb, we consistently graduate more than 8,000 students and post a graduation rate well above the state average. I am proud of all that our graduates have accomplished, and I am thankful to our entire staff for their commitment to preparing Cobb students for life,” said Board Chair David Chastain.

About **78%** of the Class of 2022 has plans to continue their educational journey at a college or university. Those schools range from universities in their own backyard, like Kennesaw State University, to schools overseas. Some are enrolling at Ivy League schools while others have been invited to attend military academies including the U.S. Air Force Academy and U.S. Naval Academy.

In addition to their scholarship awards, the Class of 2022 earned a host of accolades across their high school career. There are numerous state and national champions, including some who claimed state titles all four years. The Class of 2022 includes multiple published authors, future

SCHOOL DISTRICT AND STUDENT PERFORMANCE

COBB SCHOOLS CELEBRATE GRADUATIONS FOR 8,000 STUDENTS, AND \$106 MILLION IN SCHOLARSHIPS (Continued)

Olympians, a national award recipient for science, technology, engineering, and math (STEM), and a student with a pending patent for biodegradable straws. Many of the graduates turning tassels this week have inspiring stories of success.

So far, at least 10 Cobb students have earned National Merit Scholarships. Some other notable scholarships include the Quest Bridge Scholarship, Reach Georgia Scholarship, Cobb Schools Foundation Scholarships, full-ride football scholarships, multiple Posse Scholarships, among other scholarships. More students in the Cobb Schools Class of 2022 earned the title of Georgia Scholar than any other district in the state.

The valedictorians in the Cobb Schools Class of 2022 boast an average GPA of about 4.7 and the salutatorians are close behind.

When the Cobb students were not earning state and national accolades, they were giving back to their community. Over the course of their 4-years in high school, the Class of 2022 posted about 100,000 in community service hours.



SCHOOL DISTRICT AND STUDENT PERFORMANCE

COBB HIGH SCHOOLS CONTINUE TO RANK AMONG THE BEST



The U.S. News recently released its **Ranking for the Best High Schools for 2022**. Once again, the Cobb County School District stands out for providing learning environments that help students succeed. Out of the 18,000 public high schools ranked by U.S. News, **13 high schools in Cobb ranked in the top 40% nationally**, achieving the status as U.S. News Best High Schools: Allatoona High School, Campbell High School, Harrison High School, Hillgrove High School, Kell High School, Kennesaw Mountain High School, Lassiter High School, McEachern High School, North Cobb High School, Pope High School, Sprayberry High School, Walton High School, and Wheeler High School.

Three Cobb high schools rank among the top 20 high schools in metro Atlanta and the entire state of Georgia: Lassiter High School, Pope High School, and Walton High School. **Lassiter and Walton** are also in **the top 10** for the same lists.

A total of eight high schools in the District top the list of Atlanta metro's top 40 high schools: Allatoona High School, Harrison High School, Hillgrove High School, Kennesaw Mountain High School, Lassiter High School, Pope High School, Walton High School, and Wheeler High School.

The same group of Cobb high schools are included in the top 50 for Georgia.

An additional five Cobb high schools rank among the 101 best high schools in Georgia: Campbell High School, Kell High School, McEachern High School, North Cobb High School, and Sprayberry High School.

The best high school rankings come on the heels of **all 16 of Cobb's traditional high schools being named 2022 AP Honor Schools**. Following the state's recent announcement, Cobb also sits at the **top of the list for the most Georgia Scholars**.

SCHOOL DISTRICT AND STUDENT PERFORMANCE

COBB HIGH SCHOOLS CONTINUE TO RANK AMONG THE BEST (Continued)



Despite the challenges related to the pandemic, Cobb students continued to outperform peers across the state and nation on the **SAT** and **ACT**, as shown in the scores released in Fall 2021. Cobb students also once again surpassed the state graduation rate.

U.S. News used graduation rates and college readiness as key metrics for the 2022 Best High Schools rankings, which includes about 18,000 public high schools across all 50 states and the District of Columbia.

SCHOOL DISTRICT AND STUDENT PERFORMANCE
COBB SCHOOLS WINS HUMAN RESOURCES AWARDS



Once Again, the Cobb County School District’s efforts to recruit the best educators and staff for Cobb students have won state-wide accolades.

In June 2022, the Cobb Schools Human Resources team won the **Best in Class Platinum Award** from the **Georgia Association of School Personnel Administrators (GASPA)** for the District’s Innovative Recruitment Practices and leading-edge recruitment strategies through the pandemic. Last year, the District won the Best in Class award for teacher recruitment. 98% of Cobb Schools educators returning for 2022-2023

Recruitment was not the only area where Cobb Schools stands out in Georgia. GASPA also awarded Cobb the **Best in Class Gold Award** for the Human Resources Website and Application System. The Cobb team was praised for how the District leverages technology to provide information so users can better identify highly-qualified candidates and also for how the District simplifies the hiring process by interfacing with the HR Systems.

The Cobb Schools Human Resources team also claimed a **Best in Class Silver Award** for the District’s Risk Management Claims Processes. They earned the award for how District staff streamlined processes related to how employees submit claims to Risk Management.

“Our district’s dedication and perseverance over the last two years continues to be remarkable, which makes being recognized by GASPA two years in a row even more meaningful,” said **Keeli Bowen**, Cobb Schools Chief Human Resources Officer. “Our Human Resource team’s top-notch customer service is the first window candidates see as to why Cobb is truly the best place to teach, lead, and learn and one of the reasons why when people join the Cobb team, they stay.”

SCHOOL DISTRICT AND STUDENT PERFORMANCE

COBB SCHOOLS COMMUNICATIONS TEAM WINS INTERNATIONAL AWARDS



Staff members and departments across Cobb Schools often win accolades across the state, nation, and beyond. The Cobb Schools Communication Department added to the District’s list of award recipients in February 2022. They won eight international **MarCom Awards**, which honors excellence in marketing and communication while recognizing the creativity and hard work of industry professionals.

“As the Superintendent often says, we are a school district of excellence. He expects excellence, our Board expects excellence, and we hold ourselves to that standard for our students and parents. The Communications team has really modernized the ways our family receives information from their schools. We’re proud that they’re being recognized as the communication leaders they are, not only in education but across all industries,” said John Floresta, Chief Strategy & Accountability Officer.

The Cobb Schools Communications Team earned **two platinum level awards**, **three gold level awards**, and **three honorable mention awards**.

Some of the other platinum level MarCom award winners include Aflac, Amazon, Centers for Disease Control and Prevention (CDC), The National Association for the Advancement of Colored People (NAACP), and Syracuse University.

Since its inception in 2004, MarCom has evolved into one of the world’s largest and most-respected creative competitions. Each year about 6,500 print and digital entries are submitted from dozens of countries. MarCom is administered by the Association of Marketing and Communication Professionals (AMCP). The international organization, founded in 1995, consists of several thousand marketing, communication, advertising, public relations, digital, and web professionals. AMCP administers recognition programs, provides judges, and rewards outstanding achievement and service to the community.

SCHOOL DISTRICT AND STUDENT PERFORMANCE

COBB SCHOOLS COMMUNICATIONS TEAM WINS INTERNATIONAL AWARDS

Cobb Schools Communications Team MarCom Awards:

Title of Entry	Category	Award
Cobb Schools Connecting Community through Social Media	Digital Media Social Media Facebook Engagement	PLATINUM
Cobb Schools Communications Team Shines Light on District of Excellence	Team Achievement	PLATINUM
Cobb Schools – Ed-SPLOST Informational Campaign	Strategic Communications Communications/Public Relations Communication Plan	GOLD
First Day of Face-to-Face High School in Cobb County	Video/Audio Video/Film Educational Institution	GOLD
Cobb Students & Staff Return!	Video/Audio Video/Film Educational Institution	GOLD
Cobb Schools Welcomes Students Back to School 2021	Digital Media Social Media Social Video	HONORABLE MENTION
Online Training Course for CTLS Parent	Digital Media Web Element Web-based Training	HONORABLE MENTION
Ed-SPLOST Helps Fund The New Clay-Harmony Leland Elementary School	Video/Audio Video/Film Educational Institution	HONORABLE MENTION

**SCHOOL DISTRICT AND STUDENT PERFORMANCE
STUDENT PERFORMANCE RESULTS**

GEORGIA MILESTONES TESTS SCORES

COBB LEADS! COBB STUDENTS OUTPACE STATE, LARGE METRO PEERS



The most recent release of Georgia Milestones scores marked the first time that many students across the state were assessed following the COVID-19 pandemic. Even with the challenges of the past few years, students across the Cobb County School District outperformed their state and large metro Atlanta peers. The results show:

- Cobb students scored higher than Georgia students in all subjects and in the percentage of students reading on grade level
- Among the CCSD’s large metro Atlanta peers, and across all subject areas, Cobb has the highest mean score on the Milestones
- Among the CCSD’s large metro Atlanta peers, Cobb has the highest % of students reading at or above grade level
- Among the CCSD’s large metro Atlanta peers, and across all subject areas, Cobb has the highest % of learners considered “developing and above” (levels 2-4).
- Among the CCSD’s large metro Atlanta peers, and across all EOC subject areas, Cobb has the highest % of learners considered “proficient and above” (levels 3-4)

“In Cobb, student success is our continuous One Goal. Our students are supported by the best Team who, data continues to show, make Cobb the best place to teach, lead, and learn. I could not be more proud of our teachers going above and beyond for our students,” said Superintendent Chris Ragsdale.

Despite debate on many topics over the last two school years, this year’s round of Georgia Milestones scores show the difficult decisions made by Superintendent Chris Ragsdale, and supported by the majority of the Cobb Board of Education, benefitted Cobb students.

**SCHOOL DISTRICT AND STUDENT PERFORMANCE
STUDENT PERFORMANCE RESULTS**

GEORGIA MILESTONES TESTS SCORES (Continued)

In Cobb, decisions have been and continue to be made for students first, with support from the Team of teachers and staff who, the data says, makes Cobb the best place to teach, lead, and learn.

“Cobb’s Georgia Milestones achievements are directly related to Superintendent Ragsdale and his team’s commitment to making decisions for students first. We kept our schools open, we prioritized giving families as many choices as possible, and we created new and exciting ways for students to learn,” said Board Chair David Chastain. “I am proud of our Cobb students, and I’m proud in Cobb, we continue to offer a world-class education to all of our students.”

Cobb students outpaced their Georgia peers by double digits in multiple grades and subjects. In eighth-grade physical science, Cobb students scored more than 16 percentage points higher than their fellow Georgia students. Cobb students topped their peers by 15+ percentage points in U.S. history. The percentage of students reading on grade level in Cobb in fourth and sixth grades was more than ten percentage points higher than the rest of Georgia. For all the remaining grades, Cobb was up by more than seven percentage points.

When looking at the largest metro districts and Cobb’s closest neighbors, Cobb Schools also led with the highest percent of proficient learners (level 3) in multiple grades and subjects. For sixth grade, Cobb students posted the highest reading and math scores. That is on top of having the most developing, proficient, or distinguished learners (levels 2-4) in all subjects.



SYSTEM	ELA	MATH	SCIENCE	SOCIAL STUDIES	ALL SUBJECTS
COBB SCHOOLS	80.0%	80.7%	75.4%	81.7%	79.6%
GWINNETT	77.3%	77.9%	74.0%	80.9%	77.4%
FULTON	78.1%	75.3%	71.2%	72.7%	75.4%
MARIETTA	71.1%	76.7%	68.0%	66.1%	72.3%
DEKALB	60.9%	55.9%	53.4%	60.3%	57.8%
ATLANTA	59.4%	56.0%	53.5%	56.8%	56.9%

SCHOOL DISTRICT AND STUDENT PERFORMANCE STUDENT PERFORMANCE RESULTS

GEORGIA MILESTONES TESTS SCORES (Continued)

In addition to the Districtwide achievement, individual Cobb schools led the state in their grade level scores. Tritt Elementary School stood at the top of the list of Georgia schools for the highest percent of readers at or above reading level (98.4%) in third grade. Tritt third graders also posted one of the top reading scores in the entire state. In fourth grade, 4 of the top 10 schools for reading were Cobb Schools: Mount Bethel Elementary School (576), Timber Ridge Elementary School (574), Mountain View Elementary School (571), and Sope Creek Elementary School (568).

“As advised by the Georgia Department of Education, no one should make comparisons to previous year’s results in Cobb or across the state. The impacts of the pandemic over the last couple of years make it impossible to do so in a reliable way. We know our students are doing well compared to their peers, and we are focused on what each student knows and what they need to learn,” said John Floresta, Cobb Schools Chief Strategy & Accountability Officer.

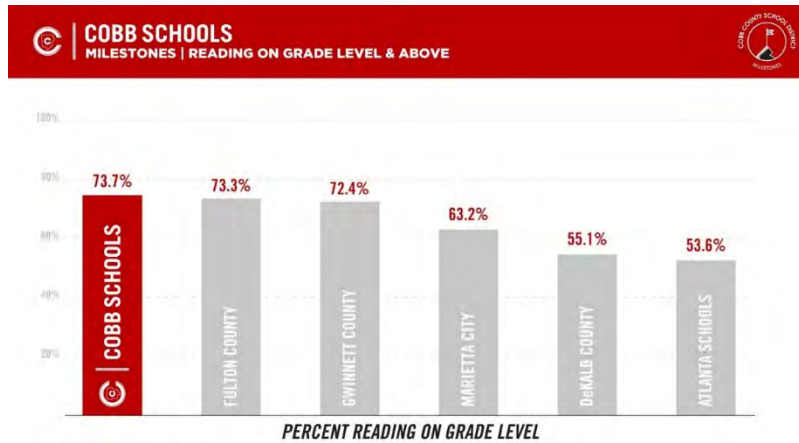

SCHOOL DISTRICT AND STUDENT PERFORMANCE STUDENT PERFORMANCE RESULTS

GEORGIA MILESTONES TESTS SCORES (Continued)

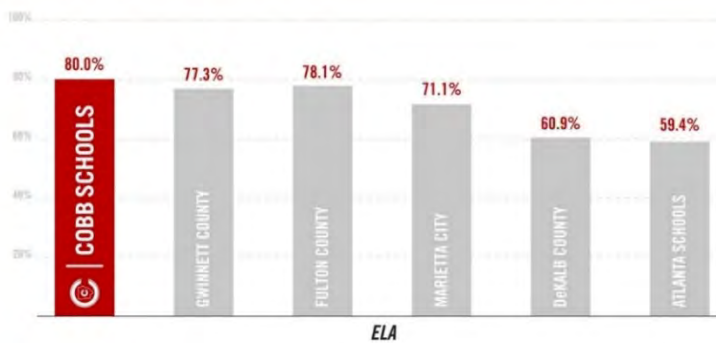
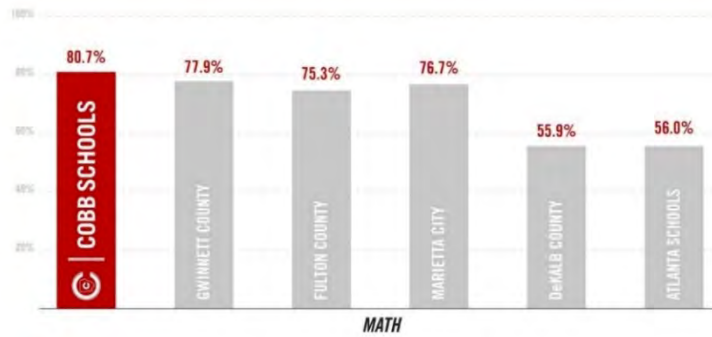
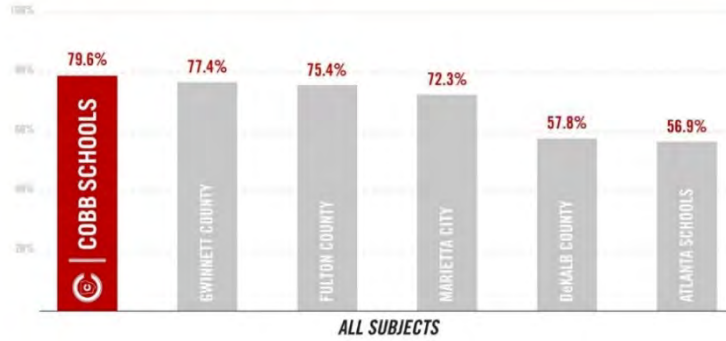

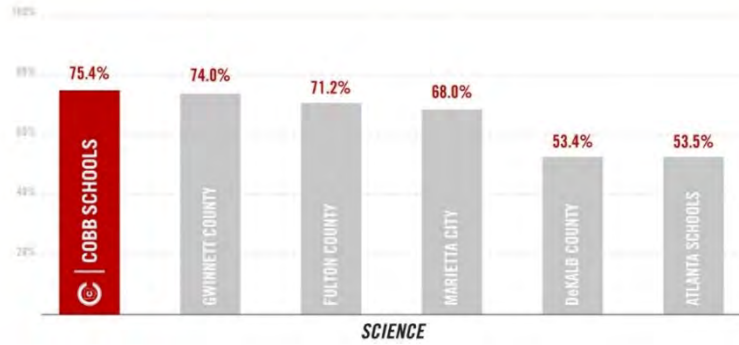
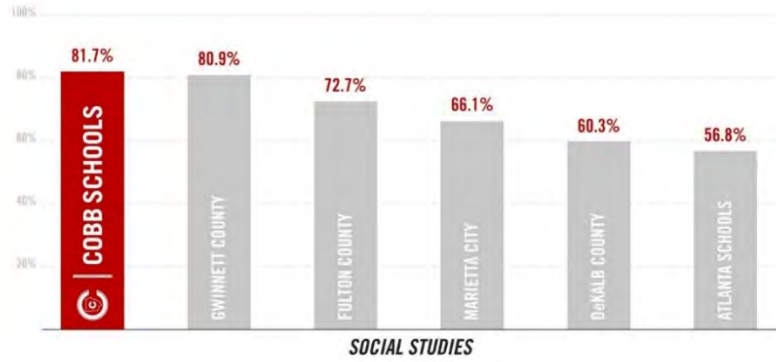

**COBB COUNTY SCHOOL DISTRICT
STUDENT PERFORMANCE RESULTS (Continued)**

SCHOLASTIC ASSESSMENT TEST (SAT) SCORES

COBB OUTPACES STATE AND NATIONAL SAT AVERAGE ONCE AGAIN



Every September, the Georgia Board of Education (GADOE) releases the final numbers for that year's graduating class's performance on the SAT. For the fifth year in a row, Georgia public school students outperformed their counterparts in the nation's public schools on the SAT with a mean score of **1052**, which is 24 points higher than the national average of **1028**.

While the state average has consistently outscored the national average, Cobb students have regularly scored higher than Georgia's average. Today, we are proud to announce that Cobb's **Class of 2022** continued a long tradition of beating the national and state averages as well as our metro Atlanta peer school districts.

"I cannot say enough about how proud I am of our teachers and the entire Team. Despite all the uncertainties and distractions of teaching and learning in a pandemic, our teachers remained focused on what is best for students. The commitment to high-quality classroom choices, supported by our Board during the pandemic, is a primary factor that led to the highest SAT scores in the metro area. Our Team, and Board, are why Cobb remains the best place to teach, lead, and learn," Superintendent Chris Ragsdale praised.

With an average score of 1111 out of a possible 1600, Cobb's Class of 2022 bested the national average of 1028 by 83 points and the Georgia state average of 1052 by 59 points. They also topped Fulton County Schools (1101) by 10 points, Gwinnett Schools (1097) by 14 points, and Marietta City (1084) by 27 points.

**COBB COUNTY SCHOOL DISTRICT
STUDENT PERFORMANCE RESULTS (Continued)**

SCHOLASTIC ASSESSMENT TEST (SAT) SCORES

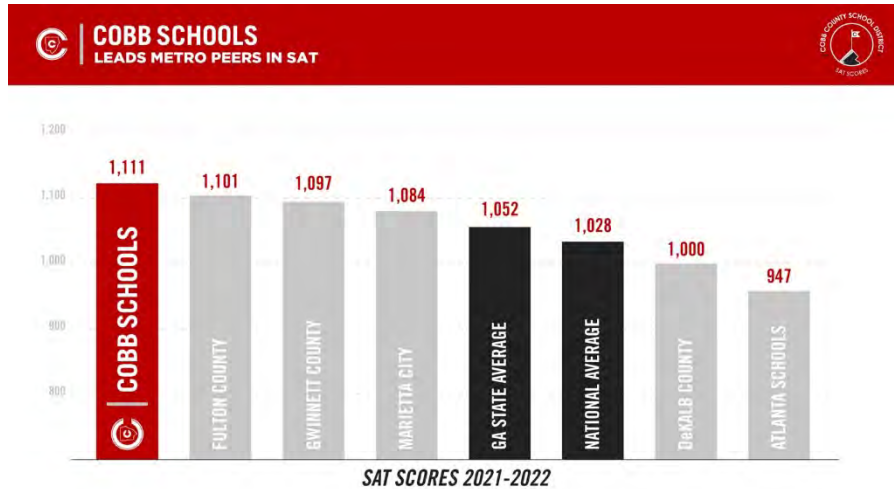

Cobb students scored better in both individual categories of the SAT as well. They posted an average of 545 out of 800 in the math portion of the test, 38 points higher than the national average (507) and 29 points higher than the state (516). On the reading and writing portions, Cobb's Class of 2022 posted an average of 566, which is 45 points higher than the national score (521) and 30 points higher than the state (536).

Cobb Schools also had 1362 more test-takers in 2022 than in 2021, **an increase of nearly 30%**.

The Class of 2022 had an unusual high school experience, to say the least. The pandemic began in March 2020 and disrupted the second half of their sophomore year. In many ways, they were the class most affected by the pandemic's fallout. As the pandemic continued, Cobb Schools decided to offer each family the choice to return to face-to-face learning, or to continue in a virtual setting, a decision directly related to and supported by the 2022 SAT average.

"The Class of 2022 could have easily blamed the pandemic and coasted in their senior year, having experienced nearly two and a half years of COVID-related learning," said Cobb's School Board Chairman David Chastain. "Instead, they chose a different path and I couldn't be prouder. These scores are encouraging, and another reason families across Georgia choose to live in Cobb. When you choose a Cobb school, you know you are getting a high-quality education and making the best decision for your family's future."

**COBB COUNTY SCHOOL DISTRICT
STUDENT PERFORMANCE RESULTS (Continued)**

AMERICAN COLLEGE TESTING (ACT) SCORES

COBB CLASS OF 2022 OUTPACE STATE AND NATIONAL AVERAGE AGAIN



Like years past and continuing the trend upheld by the recent release of the SAT scores, Cobb students posted a higher ACT average than their peers in Georgia and the nation. The Cobb Schools composite ACT score of **23.0** out of a maximum of 36 points was 1.4 points higher than the Georgia average of 21.6 and 3.2 points higher than the national average of 19.8.

Cobb Schools tied for the highest composite ACT score of large metro Atlanta school districts: Atlanta Public Schools (19), Dekalb County (20.3), Fulton (23), Gwinnett (22.3), and Marietta City (22.9).

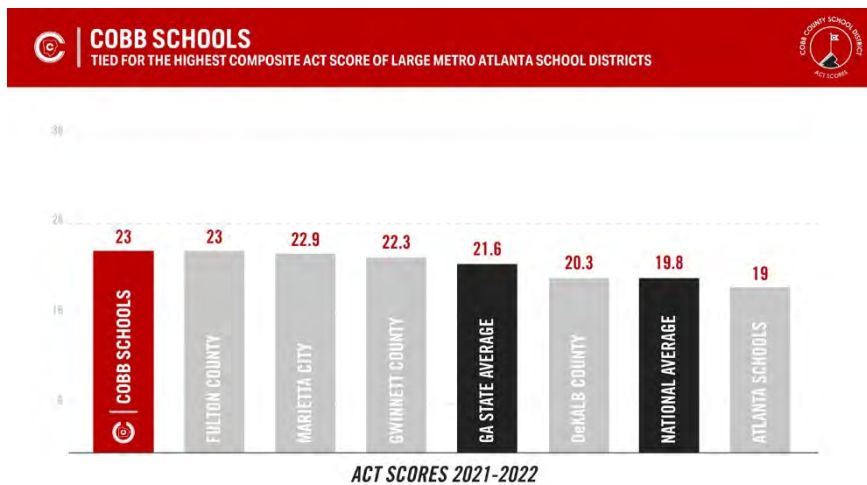

**COBB COUNTY SCHOOL DISTRICT
STUDENT PERFORMANCE RESULTS (Continued)**

AMERICAN COLLEGE TESTING (ACT) SCORES

“I am proud that I have the opportunity once again to praise the achievements of our students and the work our team of educators did to make the success possible. From the Georgia Milestones to the SAT, ACT, and Graduation Rate, the data shows we are a District of excellence, and we are committed to helping each student succeed,” said **Board Chair David Chastain**.

The scores include the most recent score for each student expected to graduate in 2022. As was the case across the state and nation, more Cobb students in the Class of 2022 took the ACT compared to 2021. However, only 22 schools in Georgia had more than 200 students participate in the ACT. That small list includes four Cobb high schools: **Harrison High School** (254), **Lassiter High School** (231), **Pope High School** (214), and **Walton High School** (294).

Cobb students topped the Georgia and national averages for each portion of the composite ACT score, which includes curriculum-based English, math, reading, and science tests. Cobb students scored 22.7 in English, 22.0 in math, 23.9 in reading, and 22.7 in science. Cobb Schools also tied for the sixth-highest composite score in the state.

Ranking among the top 15 high schools in Georgia, the top-scoring Cobb high schools earned ACT averages at or above 25: **Walton High School** (26.0), **Wheeler High School** (25.2), and **Pope High School** (25.0). With the addition of **Lassiter High school** (24.7) and **Kennesaw Mountain High School** (24), a total of 5 Cobb high schools scored in the top 30 across the state.

In addition to the success of the District and individual schools, individual Cobb students also stood out for their achievements on the test. Four students in the Cobb Schools 2022 graduating class scored a perfect composite score of 36.0. Those students attended **Campbell High School**, **Kennesaw Mountain High School**, **Walton High School**, and **Wheeler High School**.



**COBB COUNTY SCHOOL DISTRICT
STUDENT PERFORMANCE RESULTS (Continued)**

FOUR-YEAR GRADUATION RATE

**COBB STUDENTS SECOND HIGHEST GRADUATION RATE IN THE METRO AND
TOP STATE GRADUATION RATE**



Although Georgia posted [an all-time high state graduation rate](#) of 84.1%, it was not enough to surpass the graduation rate for Cobb Schools. In fact, the state’s rate lagged 3.3 percentage points behind the rate at which Cobb students graduated in 2022.

Cobb students earned a federally calculated graduation rate of 87.4%. That is 5.9 percentage points higher than the District’s graduation rate in 2015. Each of Cobb's traditional high schools also have higher graduation rates when compared to that same year.

In addition to outpacing the state’s graduation rate, Cobb students showcased one of the highest graduation rates in the Atlanta metro area.

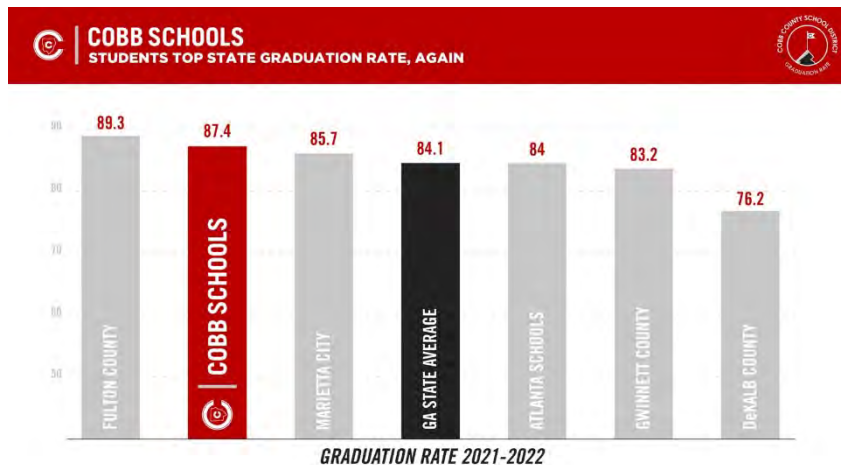

**COBB COUNTY SCHOOL DISTRICT
STUDENT PERFORMANCE RESULTS (Continued)**

FOUR-YEAR GRADUATION RATE

“I am proud and not at all surprised that our students once again demonstrated one of the highest success rates in the state. It is all thanks to our dedicated teachers and Superintendent Ragsdale’s continued commitment to teaching and learning. While others kept schools closed and directed attention away from the classroom, Cobb stayed focused on what really matters, helping each student succeed, and it shows,” said Board Chair David Chastain.

The Cobb high schools with the highest graduation rates all recorded rates above 95%: Harrison High School (97.2%), Lassiter High School (97.0%), Pope High School (96.8%), Walton High School (96.5%), and Hillgrove High School (95.7%).

The graduation rate for 9 Cobb high schools surpassed 90%, and an additional 4 Cobb high schools topped 85%.

Several Cobb high schools increased their graduation rates. With the addition of the Cobb Online Learning Academy, Cobb Horizon High School’s graduation rate increased by 21.5 percentage points compared to 2021.

Three schools increased by more than two percentage points compared to 2021: Kell High School (+2.4), Kennesaw Mountain High School (+2.3), and McEachern High School (+2.2). Sprayberry High School increased by 1.9 percentage points.

The federally mandated method for calculating the 4-year graduation rate includes all students expected to graduate in 2022, including those enrolled for a single day.

However, the District’s graduation rate jumps to 92.6% for students enrolled for a minimum of two years in Cobb Schools. The graduation rate climbs to 95.4% for students enrolled for three years in Cobb. Both of those graduation rates are higher than in 2021.

Cobb's 16 traditional high schools all have graduation rates above 96.5% for students who attended all four years, with some schools either achieving a 100% graduate rate or very close.

In addition to the graduation rate rising for all Cobb students combined, Cobb students with disabilities also posted a higher graduation rate of 79.3 compared to the prior year's rate of 78. Since 2016, the graduation rate for students with disabilities has risen by 17 percentage points.

**COBB COUNTY SCHOOL DISTRICT
STUDENT PERFORMANCE RESULTS (Continued)**

FOUR-YEAR GRADUATION RATE

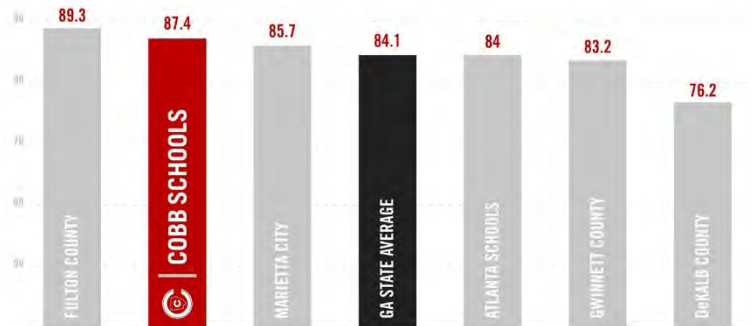
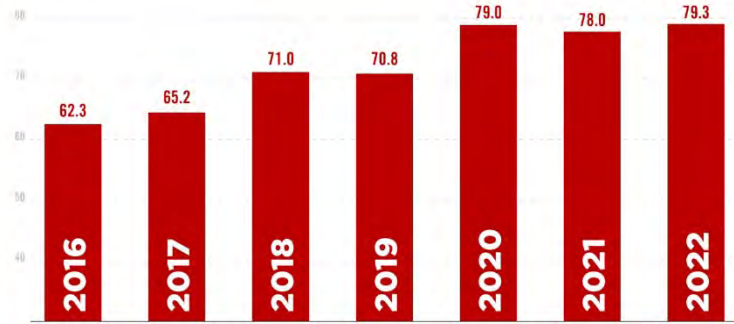

GRADUATION RATE 2021-2022

**COBB COUNTY SCHOOL DISTRICT
STUDENT PERFORMANCE RESULTS (Continued)**

FOUR-YEAR GRADUATION RATE

Annual High School Students Dropping Out Rate

Group	2015-16	2016-17	2017-18	2018-2019	2019-2020	2020-2021
All Students	3.1%	2.8%	2.9%	2.8%	2.4%	3.2%
Asian/ Pacific Islander	0.5%	0.6%	0.8%	0.4%	0.8%	0.9%
Black	3.7%	3.4%	3.1%	3.2%	2.7%	3.3%
Hispanic	5.6%	4.9%	5.5%	4.9%	4.2%	6.1%
American Indian/ Alaskan	-	-	-	-	-	-
White	1.8%	1.8%	1.6%	1.7%	1.5%	1.7%
Multi-Racial	0.3%	3.1%	2.8%	2.2%	2.0%	2.5%
Student with Disability	5.2%	4.8%	4.2%	4.1%	3.4%	4.7%
English language Learners	8.2%	6.9%	8.4%	6.2%	5.2%	9.4%
Economically Disadvantaged	4.7%	4.1%	4.3%	4.3%	3.6%	3.2%

**COBB COUNTY SCHOOL DISTRICT
STUDENT PERFORMANCE RESULTS (Continued)**

EXPENDITURES PER FTE

Compared to the average school system in Georgia, Cobb County spends less on operation and support, and more on student instruction.

According to the latest available *State DOE Report Card, 2020-2021*, Cobb County spent **69.81%** of its total General Fund expenditures on instruction. The Georgia State system average is 66.32%. The following table is the presentation of K-12 expenditures in category details, by percent and per FTE (student full-time equivalency).

K – 12 Expenditures in General Fund

	COBB COUNTY		STATE OF GEORGIA	
	Percent	Per FTE	Percent	Per FTE
Instruction	69.81%	\$6,696	66.32%	\$6,499
Media	1.63%	\$156	1.54%	\$151
Instructional Support	4.03%	\$387	4.92%	\$482
Pupil Services	3.12%	\$299	4.53%	\$444
General Admin	2.03%	\$195	2.63%	\$258
School Admin	7.29%	\$699	7.14%	\$700
Transportation	4.61%	\$442	4.85%	\$475
Maint & Operation	7.26%	\$696	7.94%	\$778
Capital Projects	0.18%	\$17	0.03%	\$3
School Food Svcs	0.04%	\$4	0.07%	\$7
Debt Services	0%	\$0	0.03%	\$3
Total	100%	\$9,592	100%	\$9,800

Data Source: Governor’s Office of Student Achievement **2020-2021** State Report Card as latest available.

Informational & Statistical Data

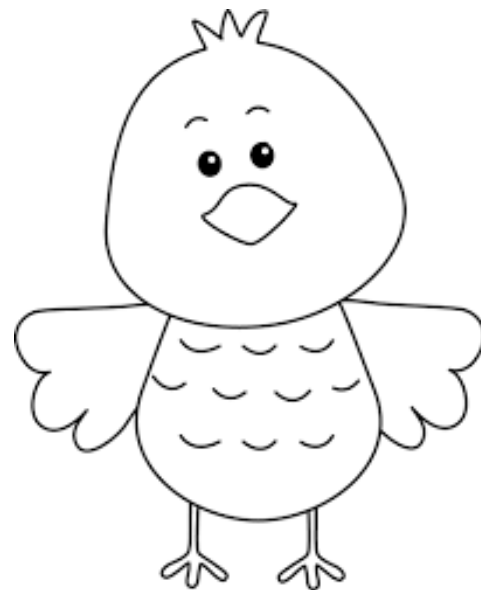

STATISTICAL SECTION (Unaudited)

This part of the District's Annual Comprehensive Financial Report presents detailed information as a context for understanding what the information in the financial statements, note disclosures and required supplementary information says about the District's overall financial position.

Contents

Financial Trends

These schedules contain trend information to help the reader understand how the District's financial performance has changed over time.

Revenue Capacity

These schedules contain information to help the reader understand and assess the District's most significant own-source revenue, the property tax.

Debt Capacity

These schedules present information to help the reader assess the affordability of the District's current level of outstanding debt and the District's ability to issue additional debt in the future.

Demographic and Economic Information

These schedules offer demographic and economic indicators to help the reader understand the environment within which the District's financial activities take place.

Operating Information

These schedules contain operating statistics, capital asset data, staffing information and key performance indicators to help the reader understand how the information in the District's financial report relates to the services the District provides and the activities it performs.

Sources:

Unless otherwise noted, the information contained here is derived from annual comprehensive financial reports for the indicated years. The District began implementation of GASB Statements No. 68 and 71 as of July 1, 2014, implementation of GASB Statement No. 75 as of July 1, 2017 and the implementation of GASB Statement No. 87 as of July 1, 2021.

**COBB COUNTY SCHOOL DISTRICT
NET POSITION BY COMPONENT
LAST TEN FISCAL YEARS**

(amounts expressed in thousands)

Net Position Components	Fiscal Year			
	June 30, 2013	June 30, 2014	June 30, 2015(1)	June 30, 2016
Investment in Capital Assets	\$ 1,262,788	\$ 1,256,656	\$ 1,329,345	\$ 1,371,599
Restricted for:				
Capital Projects Fund	49,860	110,228	92,760	117,940
School Nutrition Service Fund	20,924	19,213	19,295	19,200
Miscellaneous Grants	20	3	43	64
GNETS	-	-	-	-
General Fund Bus Purchases	-	-	-	-
Unrestricted (Deficit)	<u>149,881</u>	<u>157,363</u>	<u>(710,349)</u>	<u>(701,830)</u>
Total Net Position	<u>\$ 1,483,473</u>	<u>\$ 1,543,463</u>	<u>\$ 731,094</u>	<u>\$ 806,973</u>

(1) Net position was restated due to the implementation of GASBS Nos. 68 and 71, effective July 1, 2014.

(2) Net Position was restated due to the implementation of GASBS Nos. 75, effective July 1, 2017.

(3) Net Position was restated due to the implementation of GASB No. 87 effective July 1, 2021.

Source: District Records

Fiscal Year					
<u>June 30, 2017</u>	<u>June 30, 2018(2)</u>	<u>June 30, 2019</u>	<u>June 30, 2020</u>	<u>June 30, 2021</u>	<u>June 30, 2022 (3)</u>
\$ 1,444,579	\$ 1,463,720	\$ 1,535,405	\$ 1,604,839	\$ 1,627,347	\$ 1,655,625
96,550	123,455	104,068	92,605	112,909	170,017
19,198	18,910	18,247	8,347	5,712	30,108
-	-	33	50	159	278
-	-	311	306	183	189
-	-	-	-	927	927
<u>(731,265)</u>	<u>(1,625,362)</u>	<u>(1,536,928)</u>	<u>(1,530,921)</u>	<u>(1,517,147)</u>	<u>(1,324,813)</u>
<u>\$ 829,062</u>	<u>\$ (19,277)</u>	<u>\$ 121,136</u>	<u>\$ 175,226</u>	<u>\$ 230,090</u>	<u>\$ 532,331</u>

**COBB COUNTY SCHOOL DISTRICT
CHANGES IN NET POSITION
LAST TEN FISCAL YEARS**

(amounts expressed in thousands)

	Fiscal Year			
	June 30, 2013	June 30, 2014	June 30, 2015	June 30, 2016
Governmental Activities				
Expenses:				
Instruction	\$ 685,671	\$ 677,187	\$ 704,451	\$ 754,427
Pupil Services	27,093	26,938	27,468	31,201
Instructional Services	53,389	45,115	47,475	45,668
School and Administrative Services	156,481	161,460	173,717	186,859
Student Transportation	46,888	49,563	49,975	52,503
Maintenance and Operations	70,437	63,398	53,469	59,762
School Nutrition Program	-	419	-	-
Student Activities	28,525	30,780	32,164	31,116
Interest and Fiscal Charges	-	-	-	-
Total Governmental Expenses	<u>\$ 1,068,484</u>	<u>\$ 1,054,860</u>	<u>\$ 1,088,719</u>	<u>\$ 1,161,536</u>
Program Revenues				
Charges For Services:				
Instruction	\$ 1,101	\$ 913	\$ 1,121	\$ 1,192
Pupil Services	10	13	10	11
School and Administrative Services	29,104	28,035	27,963	29,008
Maintenance and Operations	1,842	2,004	1,830	1,127
Student Activities	28,608	30,970	31,193	31,169
Operating Grants and Contributions	504,819	512,800	545,592	579,489
Capital Grants and Contributions	7,524	8,085	5,867	18,902
Total Governmental Expenses	<u>\$ 573,008</u>	<u>\$ 582,820</u>	<u>\$ 613,576</u>	<u>\$ 660,898</u>
Governmental Net Expenses	<u>\$ (495,476)</u>	<u>\$ (472,040)</u>	<u>\$ (475,143)</u>	<u>\$ (500,638)</u>
General Revenues and Other Changes in Net Position				
General Revenues				
Taxes:				
Property Taxes Levied for General Purposes	\$ 400,271	\$ 404,759	\$ 421,043	\$ 443,533
Sales Tax	121,008	121,712	126,923	128,980
Intergovernmental	-	-	-	-
Interest Income	1,632	1,697	1,352	1,242
Gain on Sale of Capital Assets	-	175	-	-
Other	1,347	3,687	1,769	2,762
Total General Revenues	<u>\$ 524,258</u>	<u>\$ 532,030</u>	<u>\$ 551,087</u>	<u>\$ 576,517</u>
Change in Net Position	<u>\$ 28,782</u>	<u>\$ 59,990</u>	<u>\$ 75,944</u>	<u>\$ 75,879</u>

Source: District Records

Fiscal Year					
June 30, 2017	June 30, 2018	June 30, 2019	June 30, 2020	June 30, 2021	June 30, 2022
\$ 834,731	\$ 842,846	\$ 833,448	\$ 976,197	1,035,625	908,906
36,683	37,822	37,209	47,402	43,170	35,776
49,846	49,754	53,378	59,389	63,289	57,860
202,694	207,198	196,042	198,713	200,280	192,376
56,325	61,737	61,112	62,984	57,665	59,496
66,763	73,717	74,614	90,260	120,068	122,130
397	-	-	-	-	-
31,075	30,691	31,664	29,450	10,818	21,965
-	167	871	1,084	466	175
<u>\$ 1,278,514</u>	<u>\$ 1,303,932</u>	<u>\$ 1,288,338</u>	<u>\$ 1,465,479</u>	<u>\$ 1,531,381</u>	<u>\$ 1,398,684</u>
\$ 1,187	\$ 1,239	\$ 1,286	\$ 1,605	\$ 1,015	\$ 1,478
11	9	-	-	-	-
29,135	37,472	39,668	34,674	11,774	21,833
898	2,401	2,329	1,507	1,748	2,303
30,977	31,664	32,246	29,661	10,785	23,127
614,312	632,068	634,436	687,696	773,299	788,912
9,714	2,658	5,650	26,356	2,294	16,861
<u>\$ 686,234</u>	<u>\$ 707,511</u>	<u>\$ 715,615</u>	<u>\$ 781,499</u>	<u>\$ 800,915</u>	<u>\$ 854,514</u>
<u>\$ (592,280)</u>	<u>\$ (596,421)</u>	<u>\$ (572,723)</u>	<u>\$ (683,980)</u>	<u>\$ (730,466)</u>	<u>\$ (544,170)</u>
\$ 473,864	\$ 504,117	\$ 546,318	\$ 580,281	\$ 621,641	\$ 654,322
132,036	137,708	144,769	147,488	161,518	190,383
-	-	-	-	-	-
1,754	3,741	6,832	5,522	657	1,659
1,694	-	12,335	-	-	-
5,021	1,964	2,882	3,132	1,514	1,757
<u>\$ 614,369</u>	<u>\$ 647,530</u>	<u>\$ 713,136</u>	<u>\$ 736,423</u>	<u>\$ 785,330</u>	<u>\$ 848,121</u>
<u>\$ 22,089</u>	<u>\$ 51,109</u>	<u>\$ 140,413</u>	<u>\$ 52,443</u>	<u>\$ 54,864</u>	<u>\$ 303,951</u>

**COBB COUNTY SCHOOL DISTRICT
FUND BALANCES, GOVERNMENTAL FUNDS
LAST TEN FISCAL YEARS**

(amounts expressed in thousands)

	Fiscal Year			
	June 30, 2013	June 30, 2014	June 30, 2015	June 30, 2016
General Fund				
Nonspendable	\$ 674	\$ 676	\$ 844	\$ 1,004
Restricted	-	-	-	-
Committed	-	5,000	10,000	8,200
Assigned	59,272	47,596	31,050	20,342
Unassigned	75,349	89,510	90,588	74,840
Total General Fund	<u>\$ 135,295</u>	<u>\$ 142,782</u>	<u>\$ 132,482</u>	<u>\$ 104,386</u>
All Other Governmental Funds				
Nonspendable	\$ 1,848	\$ 1,464	\$ 1,844	\$ 1,922
Restricted	70,804	129,444	110,264	135,367
Committed	12,577	14,790	14,990	16,169
Assigned	2,289	1,557	1,468	1,487
Unassigned	-	-	(9)	(5)
Total All Other Governmental Funds	<u>\$ 87,518</u>	<u>\$ 147,255</u>	<u>\$ 128,557</u>	<u>\$ 154,940</u>

(a) General Fund assigned fund balance increased due to the sale of assets and allocated for future use.

Source: District Records

Fiscal Year					
June 30, 2017	June 30, 2018	June 30, 2019 (a)	June 30, 2020	June 30, 2021	June 30, 2022
\$ 2,151	\$ 980	\$ 828	\$ 1,227	\$ 1,234	\$ 1,333
-	-	-	-	927	927
-	-	-	-	-	-
15,023	30,535	66,131	83,681	163,978	181,354
<u>96,064</u>	<u>109,206</u>	<u>120,705</u>	<u>139,657</u>	<u>184,619</u>	<u>198,307</u>
<u>\$ 113,238</u>	<u>\$ 140,721</u>	<u>\$ 187,664</u>	<u>\$ 224,565</u>	<u>\$ 350,758</u>	<u>\$ 381,921</u>
\$ 1,993	\$ 2,228	\$ 2,965	\$ 3,085	\$ 2,274	\$ 2,900
113,764	120,492	96,409	33,738	41,983	134,255
16,531	17,042	18,030	20,245	18,470	20,821
786	390	296	4,164	3,032	6,267
<u>(556)</u>	<u>(24)</u>	<u>-</u>	<u>-</u>	<u>-</u>	<u>-</u>
<u>\$ 132,518</u>	<u>\$ 140,128</u>	<u>\$ 117,700</u>	<u>\$ 61,232</u>	<u>\$ 65,759</u>	<u>\$ 164,243</u>

**COBB COUNTY SCHOOL DISTRICT
CHANGES IN FUND BALANCES, GOVERNMENTAL FUNDS
LAST TEN FISCAL YEARS**

(amounts expressed in thousands)

	Fiscal Year			
	2013	2014	2015	2016
REVENUES:				
Taxes	\$ 518,604	\$ 527,683	\$ 548,738	\$ 572,621
Intergovernmental	512,258	520,737	552,431	599,546
Tuition and Fees	56,088	57,170	57,750	59,022
Interest Income	1,717	1,846	1,578	1,516
Rentals	1,383	1,545	1,353	647
Athletic Ticket Sales	3,194	3,219	3,013	2,749
Other	1,347	3,687	1,769	2,481
Total Revenues	<u>1,094,591</u>	<u>1,115,887</u>	<u>1,166,632</u>	<u>1,238,582</u>
EXPENDITURES:				
Current:				
Instruction	628,513	625,644	675,310	720,608
Pupil Services	23,067	23,572	25,373	29,098
Instructional Services	51,492	43,083	46,245	44,343
School and Administrative Services	152,266	157,034	172,304	185,351
Student Transportation	43,674	45,961	45,583	47,943
Maintenance and Operations	59,473	60,286	63,466	66,190
School Nutrition Program	-	419	458	465
Student Activities	28,525	30,780	32,164	31,116
Interest and Fiscal Charges	-	-	-	-
Capital Outlay	113,346	61,466	134,408	115,357
Debt Service:				
Interest and Fiscal Charges	-	-	-	-
Total Expenditures	<u>1,100,356</u>	<u>1,048,245</u>	<u>1,195,311</u>	<u>1,240,471</u>
Excess (Deficiency) of Revenues Over				
(Under) Expenditures	<u>(5,765)</u>	<u>67,642</u>	<u>(28,679)</u>	<u>(1,889)</u>
Other Financing Sources (Uses):				
Transfers-In	21,448	1,218	1,993	4,041
Transfers-Out	(21,942)	(2,013)	(2,438)	(4,486)
Proceeds from Sale of Capital Assets	458	377	126	621
Total Other Financing Sources (Uses)	<u>(36)</u>	<u>(418)</u>	<u>(319)</u>	<u>176</u>
Net Change in Fund Balances	<u>\$ (5,801)</u>	<u>\$ 67,224</u>	<u>\$ (28,998)</u>	<u>\$ (1,713)</u>
Non-Capitalized Expenditures	<u>\$ 997,944</u>	<u>\$ 989,861</u>	<u>\$ 1,051,784</u>	<u>\$ 1,119,674</u>
Capitalized Expenditures	<u>102,412</u>	<u>58,384</u>	<u>143,527</u>	<u>120,797</u>
Total Expenditures	<u>\$ 1,100,356</u>	<u>\$ 1,048,245</u>	<u>\$ 1,195,311</u>	<u>\$ 1,240,471</u>
Debt Service as a Percentage of				
Non-Capitalized Expenditures	-	-	-	-

(a) General Fund assigned fund balance increased due to the sale of three District properties.

Source: District Records

Fiscal Year					
2017	2018	2019 (a)	2020	2021	2022
\$ 607,871	\$ 640,509	\$ 690,882	\$ 724,173	786,347	845,174
623,018	633,454	635,892	710,427	775,283	807,775
58,844	59,179	61,670	54,203	13,949	36,586
2,335	4,997	10,658	7,912	762	1,944
438	1,932	1,861	1,010	54	1,791
2,925	3,528	3,576	3,034	1,893	2,990
4,393	2,875	2,882	3,132	2,981	1,757
<u>1,299,824</u>	<u>1,346,474</u>	<u>1,407,421</u>	<u>1,503,891</u>	<u>1,581,269</u>	<u>1,698,017</u>
742,594	754,423	790,474	852,123	867,170	934,500
32,321	33,709	36,064	43,607	37,698	38,526
46,318	46,397	55,056	57,279	58,419	64,881
189,124	188,486	190,102	183,696	179,505	201,398
49,963	52,463	55,815	58,285	51,594	57,775
68,023	69,767	71,635	82,368	78,392	84,724
-	-	-	-	-	-
31,075	30,691	31,664	29,450	10,818	21,965
-	-	-	-	-	-
157,248	135,180	170,419	217,527	166,566	163,046
-	167	871	1,084	466	175
<u>1,316,666</u>	<u>1,311,283</u>	<u>1,402,100</u>	<u>1,525,419</u>	<u>1,450,628</u>	<u>1,566,990</u>
<u>(16,842)</u>	<u>35,191</u>	<u>5,321</u>	<u>(21,528)</u>	<u>130,641</u>	<u>131,027</u>
4,908	7,882	3,582	4,310	9,583	6,251
(6,103)	(8,255)	(3,955)	(4,310)	(9,748)	(6,251)
4,467	275	19,567	314	244	330
<u>3,272</u>	<u>(98)</u>	<u>19,194</u>	<u>314</u>	<u>79</u>	<u>330</u>
\$ <u>(13,570)</u>	\$ <u>35,093</u>	\$ <u>24,515</u>	\$ <u>(21,214)</u>	\$ <u>130,720</u>	\$ <u>131,357</u>
\$ 1,157,363	\$ 1,176,768	\$ 1,233,970	\$ 1,313,891	\$ 1,299,534	\$ 1,444,687
159,303	134,515	168,130	211,528	151,094	122,303
<u>\$ 1,316,666</u>	<u>\$ 1,311,283</u>	<u>\$ 1,402,100</u>	<u>\$ 1,525,419</u>	<u>\$ 1,450,628</u>	<u>\$ 1,566,990</u>
-	-	-	-	-	-

**COBB COUNTY SCHOOL DISTRICT
PROPERTY TAX LEVIES AND COLLECTIONS
JUNE 30, 2022**

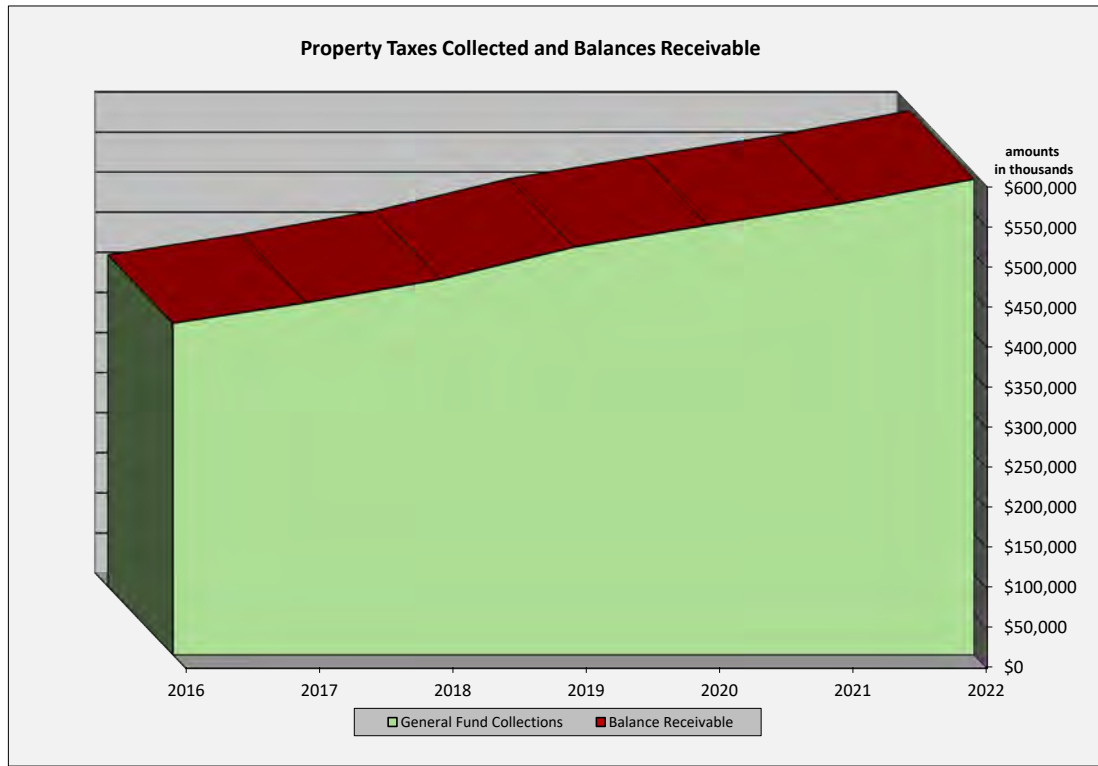

Balances as of June 30, 2022 (amounts expressed in thousands)

	<u>2016</u>	<u>2017</u>	<u>2018</u>	<u>2019</u>	<u>2020</u>	<u>2021</u>	<u>2022</u>	<u>Total</u>
General Fund:								
Total Taxes Levied	\$ 413,425	\$ 439,272	\$ 468,387	\$ 508,461	\$ 536,187	\$ 562,732	\$ 595,290	\$ 3,523,754
Collected Current Year	411,807	437,484	466,239	505,912	532,737	559,804	593,067	3,507,050
Percent of Taxes Collected	99.61%	99.59%	99.54%	99.50%	99.36%	99.48%	99.63%	99.53%
Subsequent Years Collected	\$ 1,529	\$ 1,649	\$ 1,633	\$ 1,889	\$ 2,229	\$ 2,044	\$ -	\$ 10,973
Total Collected All Years	413,336	439,133	468,218	508,265	535,830	562,231	593,067	3,520,080
Balance Receivable	\$ 89	\$ 139	\$ 169	\$ 196	\$ 357	\$ 501	\$ 2,223	\$ 3,674
Percent of Taxes Collected	99.98%	99.97%	99.96%	99.96%	99.93%	99.91%	99.63%	99.90%

Statute of limitations for collection of delinquent taxes is seven years as permitted by the State of Georgia; therefore, only seven years of data is available.

Source: Office of Tax Commissioner, Cobb County

**COBB COUNTY SCHOOL DISTRICT
 ASSESSED AND ESTIMATED ACTUAL VALUE OF TAXABLE PROPERTY
 LAST TEN FISCAL YEARS**

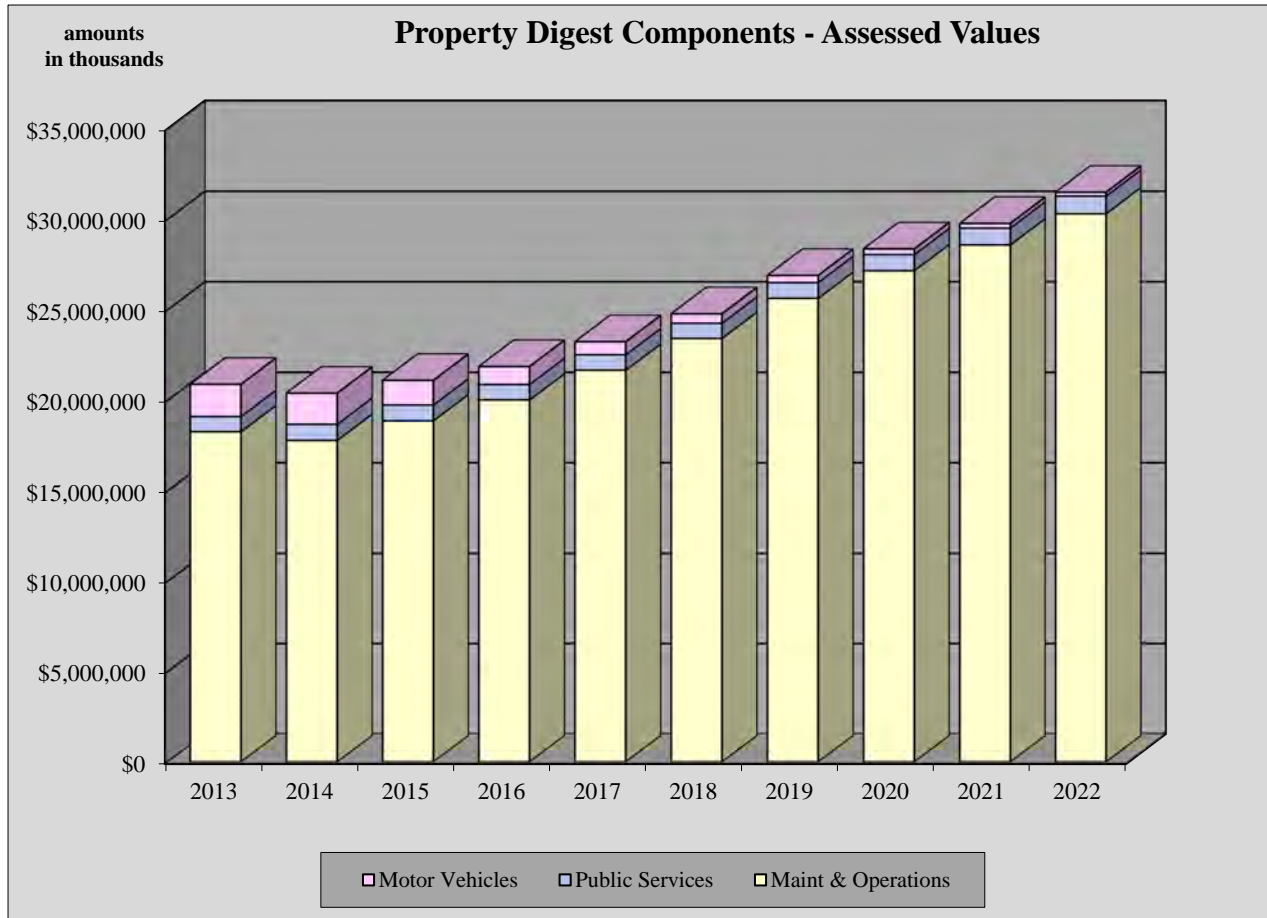

(amounts expressed in thousands)

Net M&O							
For Maintenance & Operations of Schools							
<u>Fiscal Year</u>	<u>Real Property</u>	<u>Personal Property</u>	<u>Public Services</u>	<u>Motor Vehicle</u>	<u>Total Assessed Value</u>	<u>Direct Rate</u>	<u>Estimated Actual Value</u>
2013	\$ 16,898,249	\$ 1,374,209	\$ 838,778	\$ 1,779,893	\$ 20,891,129	1.890%	\$ 52,227,822
2014	16,352,749	1,439,170	893,003	1,716,625	20,401,547	1.890%	51,003,931
2015	17,266,640	1,607,722	870,412	1,365,200	21,109,974	1.890%	52,774,935
2016	18,421,285	1,607,041	855,371	990,609	21,874,306	1.890%	54,685,822
2017	19,947,408	1,722,374	853,860	718,250	23,241,892	1.890%	58,104,731
2018	21,599,228	1,825,340	839,298	518,534	24,782,400	1.890%	61,956,001
2019	23,677,091	1,963,114	869,266	393,218	26,902,689	1.890%	67,256,723
2020	25,105,013	2,061,394	888,756	314,519	28,369,682	1.890%	70,924,205
2021	26,450,073	2,140,213	930,324	253,586	29,774,196	1.890%	74,435,489
2022	28,161,560	2,147,911	975,747	211,623	31,496,841	1.890%	78,742,102

Property Taxes - Assessments are based on 40% of the appraised market value as of January 1 each year.

Source: Office of Tax Commissioner, Cobb County

**COBB COUNTY SCHOOL DISTRICT
DIRECT AND OVERLAPPING PROPERTY TAX RATES
LAST TEN FISCAL YEARS**

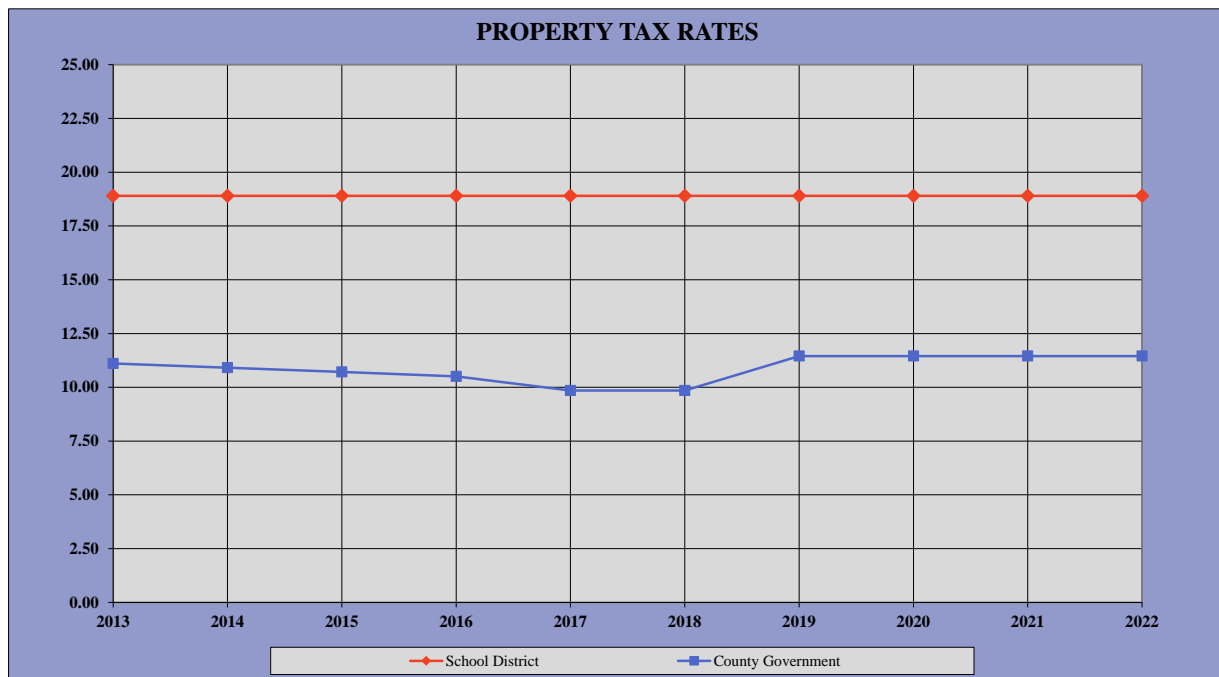

(all tax rates are per \$1000 assessed valuation)

<u>Fiscal Year</u>	<u>2013</u>	<u>2014</u>	<u>2015</u>	<u>2016</u>	<u>2017</u>	<u>2018</u>	<u>2019</u>	<u>2020</u>	<u>2021</u>	<u>2022</u>
<u>School District</u>										
Maint & Operations	18.90	18.90	18.90	18.90	18.90	18.90	18.90	18.90	18.90	18.90
Total Direct Rate	18.90	18.90	18.90	18.90	18.90	18.90	18.90	18.90	18.90	18.90
<u>County Government</u>										
General	7.72	7.52	7.32	7.12	6.66	6.76	8.46	8.46	8.46	8.46
Fire District	3.06	3.06	3.06	3.06	2.96	2.96	2.86	2.86	2.86	2.86
Debt Service	0.33	0.33	0.33	0.33	0.23	0.13	0.13	0.13	0.13	0.13
Total County Rate	11.11	10.91	10.71	10.51	9.85	9.85	11.45	11.45	11.45	11.45
State of Georgia	0.20	0.15	0.10	0.05	-	-	-	-	-	-
Total Overlapping Rate	11.31	11.06	10.81	10.56	9.85	9.85	11.45	11.45	11.45	11.45
<u>Additional Overlapping Rates</u>										
City of Acworth	7.60	7.60	7.60	7.60	7.60	7.60	7.60	7.60	8.95	8.95
City of Austell	4.00	4.00	3.06	3.06	3.06	3.25	3.25	3.25	3.25	3.25
City of Kennesaw	9.50	9.50	9.50	9.50	9.50	9.50	9.50	9.50	9.50	9.50
City of Powder Spgs	8.50	8.50	8.50	8.50	8.50	8.50	9.50	9.50	9.50	9.50
City of Smyrna	8.99	8.99	8.99	8.99	8.99	8.99	8.99	8.99	8.99	8.99

Note: Maintenance and operations tax for schools has a cap of 18.90 mills.

Source: Cobb County Government, Georgia Department of Revenue

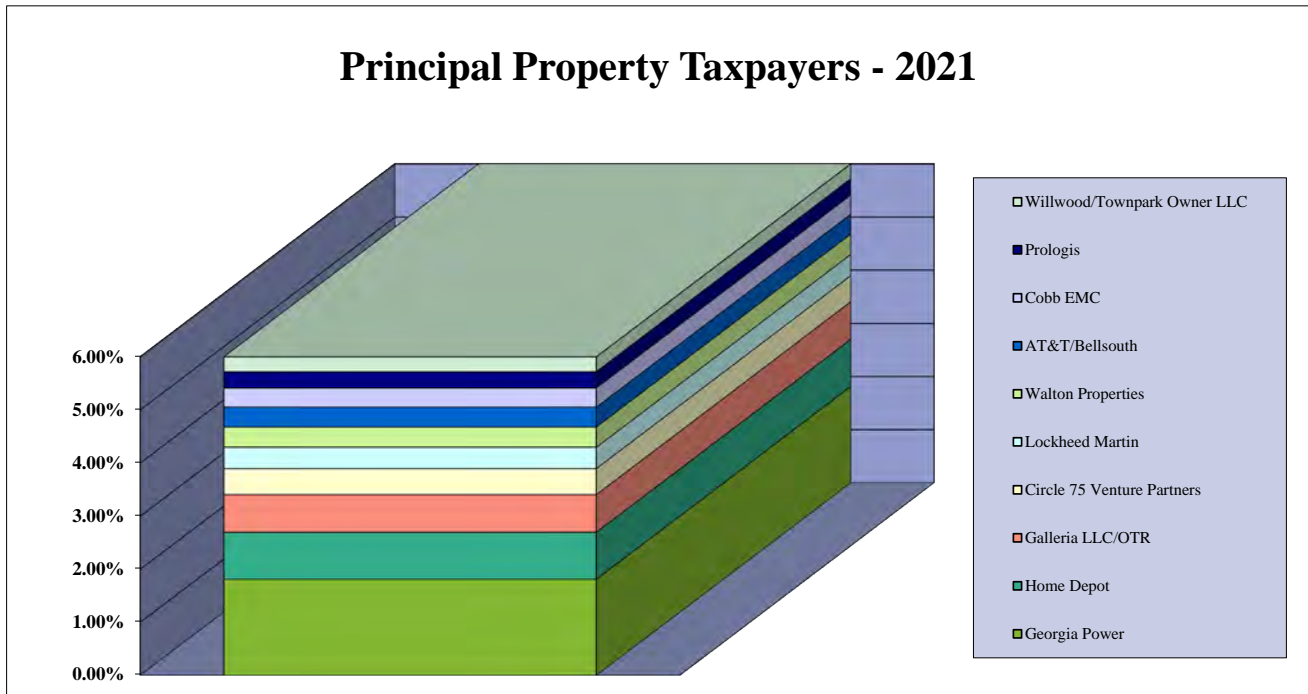

Taxpayer	Type of Business	Rank	December 31, 2021		December 31, 2012		
			Taxes Levied	Percent of Total Taxes Levied	Taxes Levied	Percent of Total Taxes Levied	
Georgia Power	Utilities	1	\$ 10,795,033	1.813%	1	\$ 9,060,911	2.295%
Home Depot	Retail	2	5,277,978	0.887%	2	3,603,663	0.913%
Galleria LLC/OTR	Real Estate	3	4,214,355	0.708%			
Circle 75 Venture Partners	Utilities	4	2,915,195	0.490%			
Lockheed Martin Corp	Aircraft	5	2,383,855	0.400%	6	1,674,132	0.424%
Walton Properties	Real Estate	6	2,274,135	0.382%	8	1,127,066	0.285%
AT&T/Bellsouth	Telecommunications	7	2,226,030	0.374%			
Cobb EMC	Utilities	8	2,144,499	0.360%	3	2,080,314	0.527%
Prologis		9	1,839,081	0.309%			
Wildwood/Townpark Owner LLC	Real Estate	10	1,751,462	0.294%			
U K Lasalle	Real Estate				10	1,061,021	0.269%
SP4 Properties	Real Estate				4	2,060,021	0.522%
CP Venture Five, LLC	Real Estate				7	1,136,319	0.288%
CRP	Real Estate				9	1,061,411	0.269%
Ohio Teacher Retirement Fund	Investmnet				5	1,840,502	0.466%
TOTAL			\$ 35,821,623	6.017%		\$ 24,705,360	6.258%

Note: School millage rate is 62% of total county rate.
 Total taxes levied are multiplied by 62% to arrive at amount of school taxes.

Information is available only by calendar year; therefore, data reported is for December 31, 2021 and nine years earlier, December 31, 2012
 Source: Office of Tax Commissioner, Cobb County, GA

**COBB COUNTY SCHOOL DISTRICT
LEGAL DEBT MARGIN INFORMATION
LAST TEN FISCAL YEARS**

(amounts expressed in thousands)

	Fiscal Year				
	2013	2014	2015	2016	2017
Debt Limit	\$ 2,089,113	\$ 2,040,157	\$ 2,110,997	\$ 2,187,433	\$ 2,324,189
Total debt applicable to limit	-	-	-	-	-
Legal Debt Margin	<u>\$ 2,089,113</u>	<u>\$ 2,040,157</u>	<u>\$ 2,110,997</u>	<u>\$ 2,187,433</u>	<u>\$ 2,324,189</u>
Total debt applicable as a percentage of debt limit	-	-	-	-	-

	Fiscal Year				
	2018	2019	2020	2021	2022
Debt Limit	\$ 2,478,240	\$ 2,690,269	\$ 2,836,968	\$ 2,977,419	\$ 3,149,684
Total debt applicable to limit	-	-	-	-	-
Legal Debt Margin	<u>\$ 2,478,240</u>	<u>\$ 2,690,269</u>	<u>\$ 2,836,968</u>	<u>\$ 2,977,419</u>	<u>\$ 3,149,684</u>
Total debt applicable as a percentage of debt limit	-	-	-	-	-

Source: District Records

**COBB COUNTY SCHOOL DISTRICT
 LEGAL DEBT MARGIN INFORMATION
 FISCAL YEAR 2022**

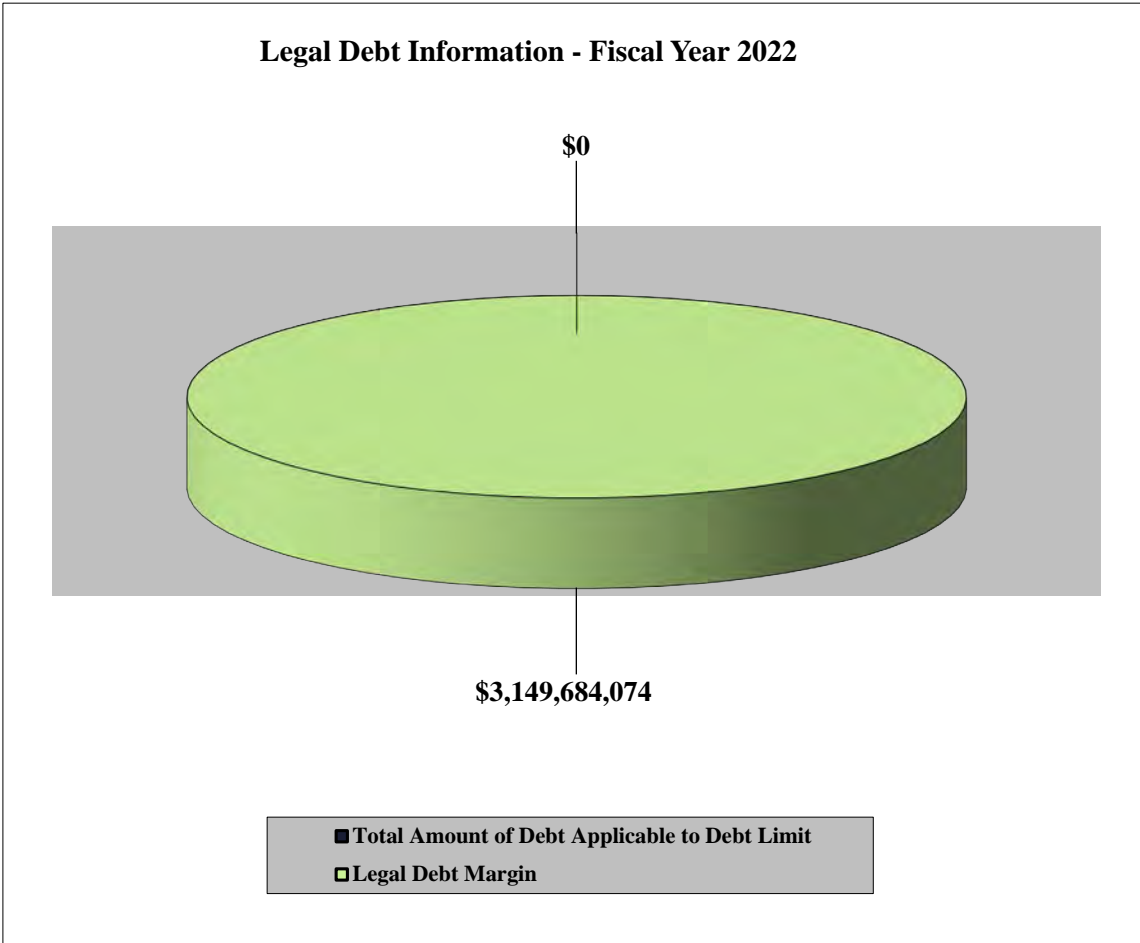

(amounts expressed in thousands)

Net Assessed Valuation, Cobb County School District, January 1, 2021	<u>\$ 31,496,840,736</u>
Debt Limit - 10% of Assessed Value	\$ 3,149,684,074
Amount of Debt Applicable to Debt Limit:	
Total Bonded Debt	\$ -
Total Amount of Debt Applicable to Debt Limit	<u>\$ -</u>
Legal Debt Margin	<u>\$ 3,149,684,074</u>

Sources: Cobb County Office of Tax Commissioner, District Records

**COBB COUNTY SCHOOL DISTRICT
RATIOS OF OUTSTANDING DEBT BY TYPE
LAST TEN FISCAL YEARS**

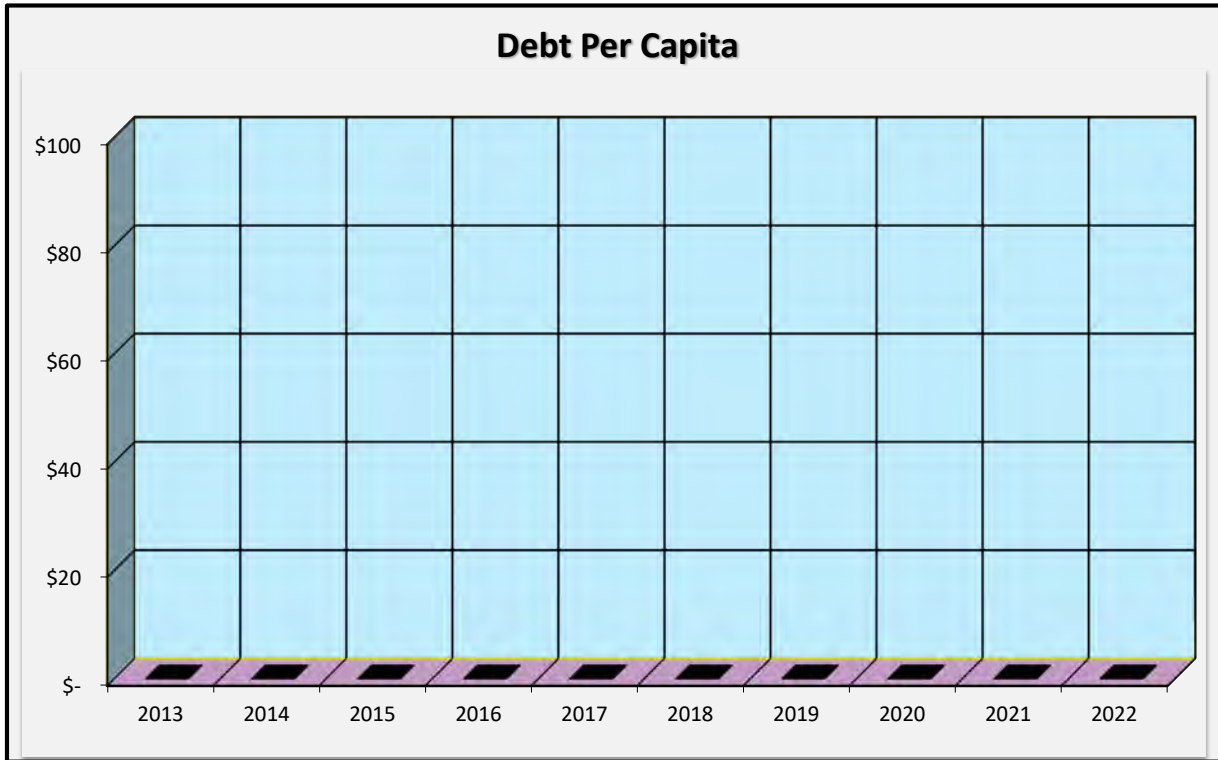

(amounts expressed in thousands, except per capita)

Fiscal Year	General Obligation Bonds	Capital Leases	Total Primary Government Debt	Annual Personal Income	Population	Debt as a Percentage of Personal Income	Total Debt Per Capita
2013	-	-	- \$	33,662,185	649,141	-	\$ -
2014	-	-	-	34,419,921	658,101	-	\$ -
2015	-	-	-	36,192,750	670,967	-	\$ -
2016	-	-	-	36,400,450	682,267	-	\$ -
2017	-	-	-	38,385,767	687,209	-	\$ -
2018	-	-	-	40,281,455	694,706	-	\$ -
2019	-	-	-	43,263,716	696,059	-	\$ -
2020	-	-	-	44,995,411	699,274	-	\$ -
2021	-	-	-	48,229,082	705,177	-	\$ -
2022	-	-	-	51,847,811	705,305	-	\$ -

Notes:

Cobb County School District information based on fiscal years beginning July 1 and ending June 30. Demographic and economic data provided by calendar year.

Population of 705,305 provided by the US Census Bureau (population estimate July 1, 2021); excludes the City of Marietta.

Annual Personal Income data is as of December 31st of the fiscal year.

NA - Information not available at time of publication.

Sources: District Records, Annual Personal Income: US Department of Commerce Bureau of Economic Analysis.

**COBB COUNTY SCHOOL DISTRICT
 RATIO OF NET GENERAL BONDED DEBT TO ESTIMATED ACTUAL VALUE
 AND NET BONDED DEBT PER CAPITA
 LAST TEN FISCAL YEARS**

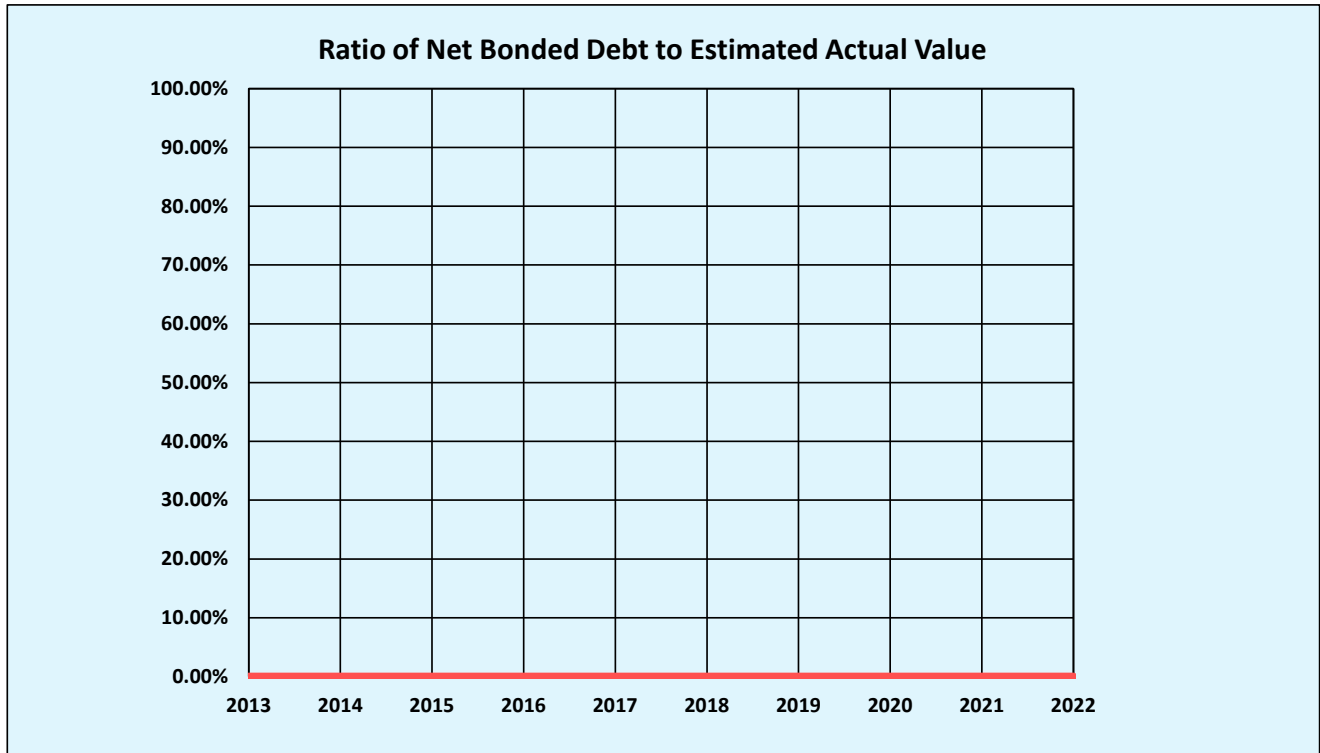

Fiscal Year	Population	Estimated Actual Value	Gross Bonded Debt	Restricted for Bonded Debt	Net Bonded Debt	Ratio of Net Bonded Debt to Est. Actual Value	Net Bonded Debt Per Capita
2013	649,141	\$ 52,227,822,000	-	-	-	-	-
2014	658,101	51,003,931,000	-	-	-	-	-
2015	670,967	52,774,935,000	-	-	-	-	-
2016	682,267	54,685,822,000	-	-	-	-	-
2017	687,209	58,104,731,000	-	-	-	-	-
2018	694,706	61,956,000,536	-	-	-	-	-
2019	696,059	67,256,722,613	-	-	-	-	-
2020	699,274	70,924,204,555	-	-	-	-	-
2021	705,177	74,435,488,855	-	-	-	-	-
2022	705,305	78,742,101,840	-	-	-	-	-

Note:
 Population provided by US Census Bureau (2021 estimate); excludes the City of Marietta.

**COBB COUNTY SCHOOL DISTRICT
COMPUTATION OF DIRECT AND OVERLAPPING GENERAL OBLIGATION DEBT
JUNE 30, 2022**

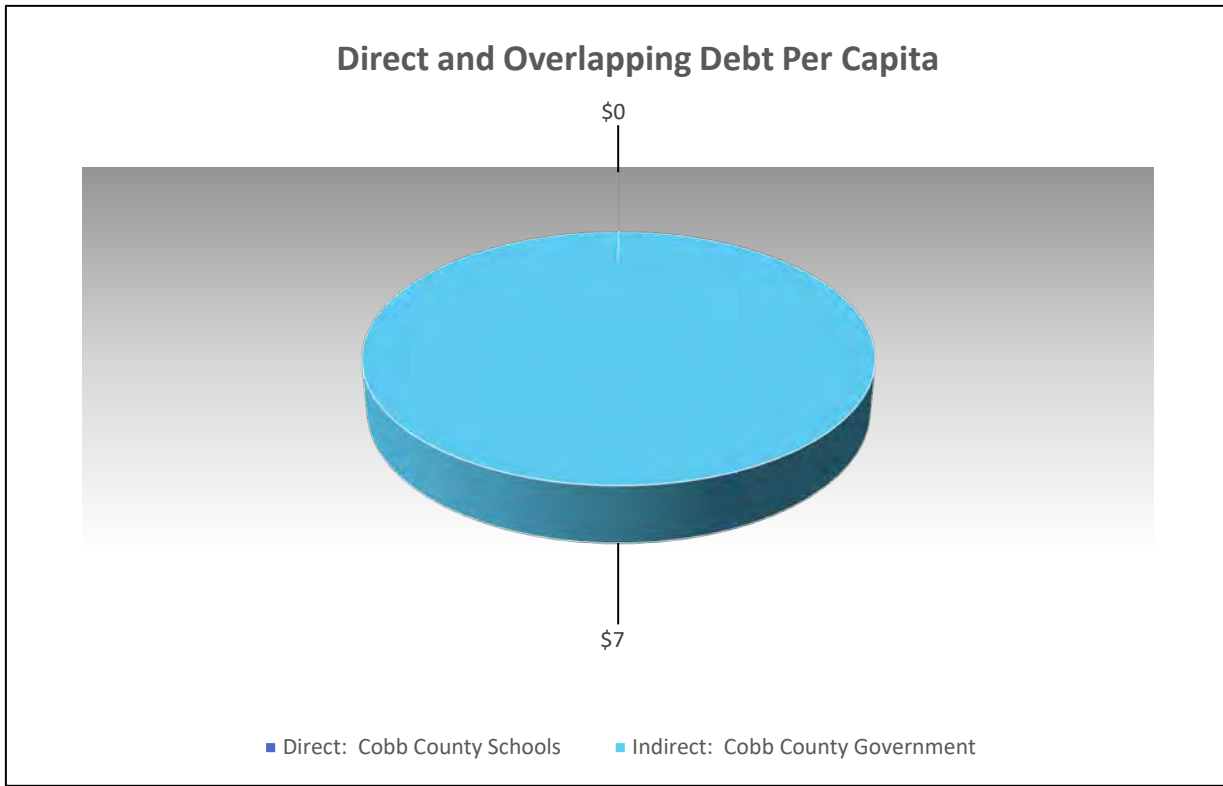

Direct General Obligation Debt:			
Gross Bonded Debt	\$	-	\$ -
Overlapping General Obligation Debt:			
Cobb County Government (99.9% of \$4,650,000)	\$	4,645,350	
			<u>\$ 4,645,350</u>
Total Direct and Overlapping General Obligation Debt			<u><u>\$ 4,645,350</u></u>
Debt Per Capita:*			
Direct General Obligation Debt	\$		-
Overlapping General Obligation Debt			<u>7</u>
Total	\$		<u><u>7</u></u>

*Population of 705,177 from US Census Bureau (less estimated population for City of Marietta).

Note: The overlap percentage is determined by the percentage of Fire District to Debt Service Fund of Cobb County Government.

**COBB COUNTY SCHOOL DISTRICT
COBB COUNTY DEMOGRAPHIC AND ECONOMIC STATISTICS
LAST TEN CALENDAR YEARS**

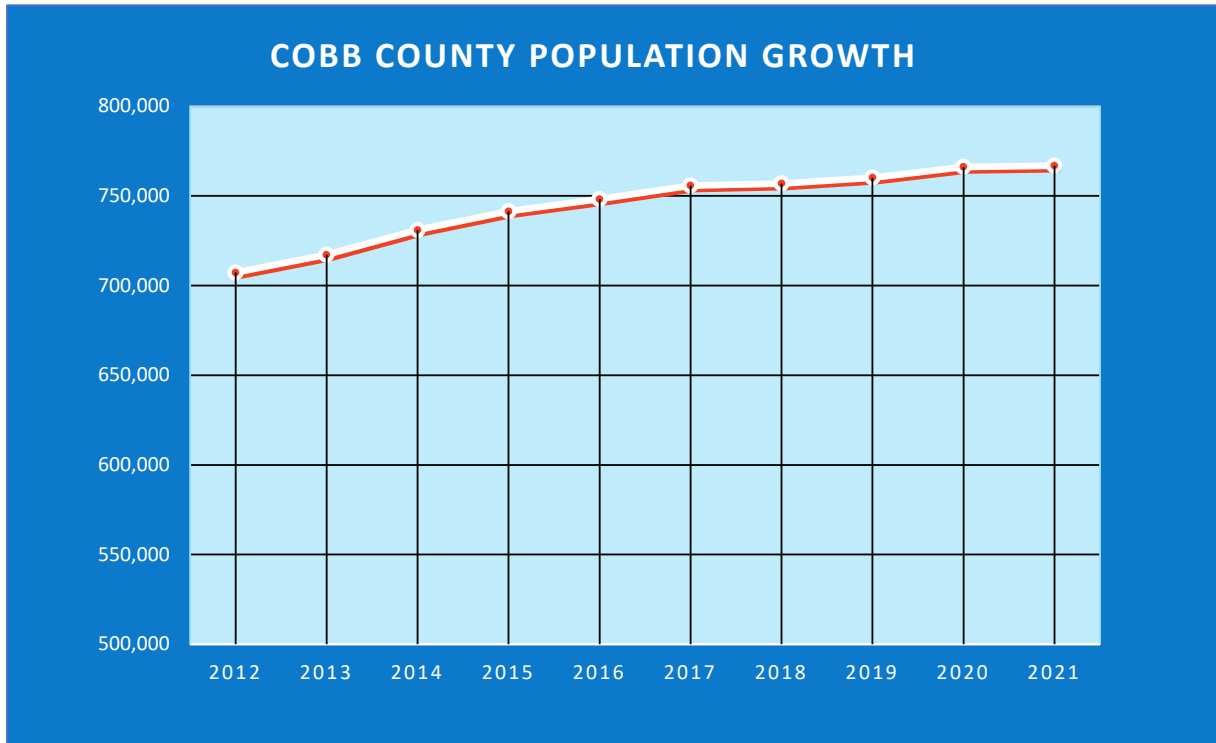

Calendar Year	Population	Personal Income (In Thousands)	Per Capita Personal Income	Median Household Income	Median Age	Active Student Enrollment(a)	Unemployment Rate
2012	707,277	\$ 33,662,185	\$ 47,594	\$ 65,423	35.4	107,914	8.0%
2013	717,190	34,419,921	47,993	66,300	36.1	109,529	7.1%
2014	730,981	36,192,750	49,513	68,656	36.2	111,060	6.0%
2015	741,334	36,400,450	49,101	70,246	36.3	111,848	5.0%
2016	748,150	38,385,767	51,308	70,947	36.5	112,412	4.6%
2017	755,754	40,281,455	53,300	75,654	36.6	111,482	4.4%
2018	756,865	43,263,716	57,162	78,894	36.7	111,386	3.7%
2019	760,141	44,995,411	59,194	79,601	37.3	111,760	3.0%
2020	766,149	48,229,082	63,214	NA (b)	NA(b)	106,983	5.9%
2021	766,802	51,847,811	67,616	88,029	37.7	106,601	3.3%

Notes:

(a) Student Enrollment is based on the data for the end of the school year which is subsequent to the calendar year end.

(b) For 2020 data is only recorded at the state level

Sources:

Population (includes city of Marietta), provided by the US Census Bureau (population census estimates as of July 1, 2021). Personal Income, and Per Capita Personal Income from US Bureau of Economic Analysis.

Median Household Income and Unemployment Rate from Georgia Department of Labor (HUD and US Census Bureau estimates).

Median Age from US Census Bureau.

**COBB COUNTY SCHOOL DISTRICT
PRINCIPAL EMPLOYERS
CURRENT YEAR AND NINE YEARS AGO**

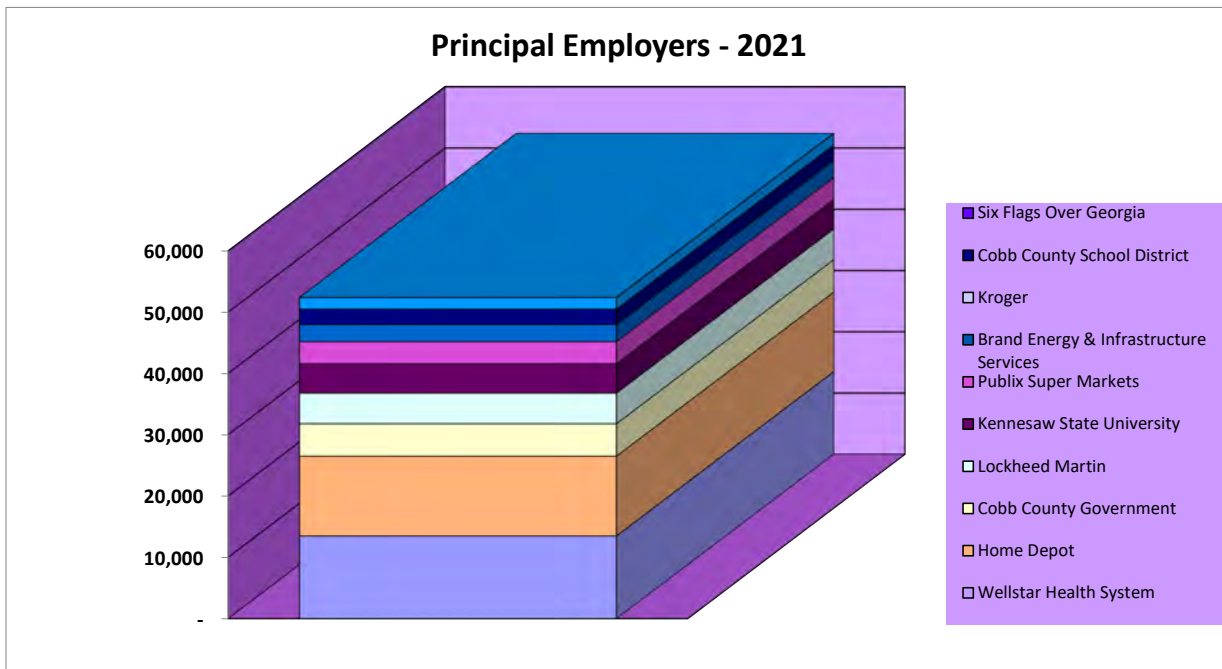

Employer	2021			2012		
	Rank	Employees	Percentage of Total County Employment	Rank	Employees	Percentage of Total County Employment
Wellstar Health System	1	13,500	3.76%	3	12,746	3.64%
Cobb County School District	2	13,484	3.76%	2	14,107	3.64%
Home Depot	3	13,000	3.62%	1	20,000	5.71%
Cobb County Government	4	5,292	1.47%	6	4,210	1.20%
Lockheed Martin	5	5,000	1.39%	4	6,900	1.97%
Kennesaw State University	6	4,800	1.34%	5	4,404	1.26%
Publix Super Markets	7	3,600	1.00%	7	2,988	0.85%
Brand Energy & Infrastructure Services	8	2,801	0.78%		-	0.00%
Kroger Co.	9	2,500	0.70%	9	2,383	0.68%
Six Flags Over Georgia	10	1,900	0.53%			
Dobbins Air Force Base	-	-	-	8	2,547	0.73%
Walmart	-	-	-	10	2,258	0.64%
Total		65,877	18.35%		72,543	20.32%

Information is available by calendar year; therefore, data reported is for years ended December 31, 2021, and nine years earlier, December 31, 2012. Principal Employers within the county provided by 2021 and 2012 Cobb County Government Comprehensive Annual Financial Reports.

School District employee totals include each employee in his/her primary job position only.

Sources: District Records, Cobb County Government, US Bureau of Labor Statistics

**COBB COUNTY SCHOOL DISTRICT
COMPARISON OF METROPOLITAN ATLANTA SCHOOL DISTRICT
PROPERTY TAX RATES
JUNE 30, 2022**

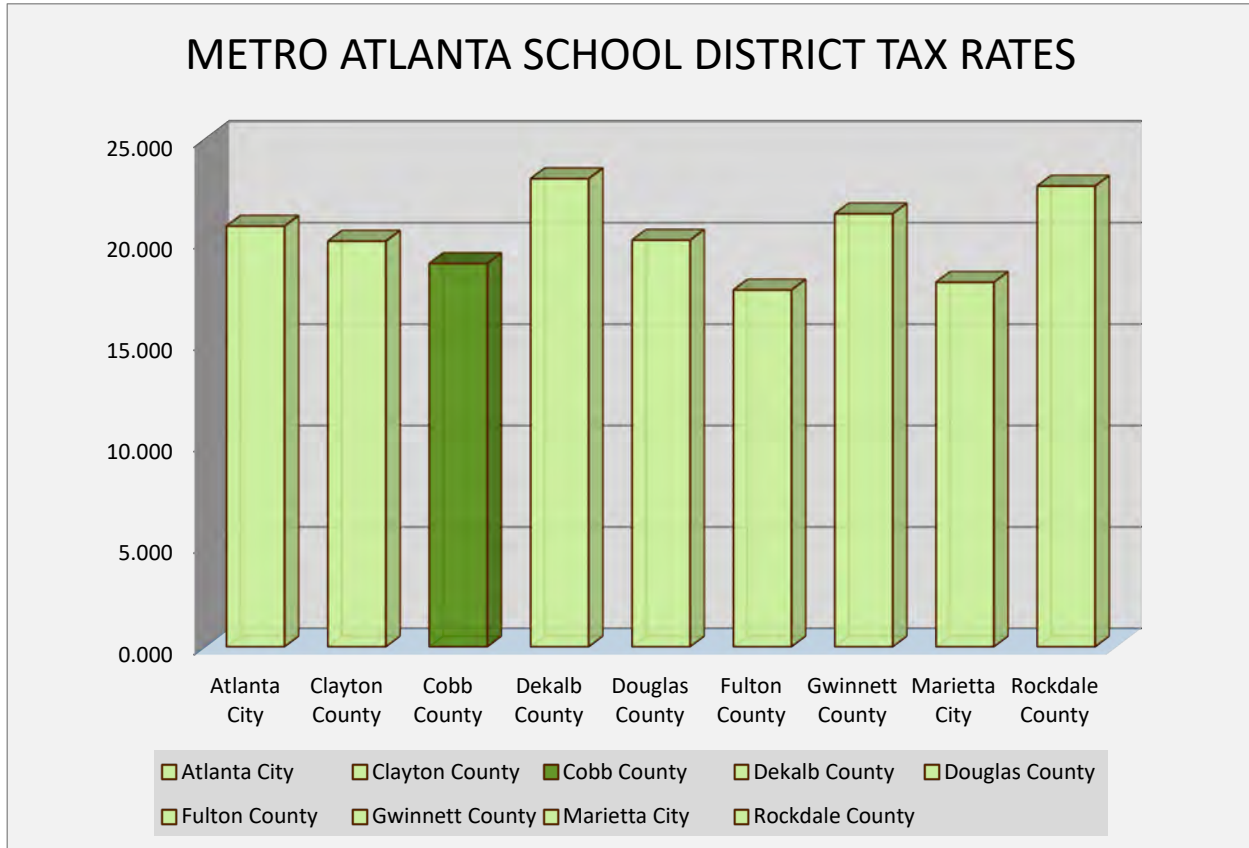

(all tax rates are per \$1000 assessed valuation)

<u>School District</u>	<u>Total Rate</u>	<u>Maintenance & Operations</u>	<u>Debt Service</u>
Atlanta City	20.740	20.740	0.000
Clayton County	20.000	20.000	0.000
Cobb County	18.900	18.900	0.000
Dekalb County	23.080	23.080	0.000
Douglas County	20.050	19.550	0.500
Fulton County	17.590	17.590	0.000
Gwinnett County	21.350	19.700	1.650
Marietta City	17.970	17.970	0.000
Rockdale County	22.717	22.717	0.000

Source: Georgia Department of Revenue

**COBB COUNTY SCHOOL DISTRICT
COBB COUNTY BANK DEPOSITS, CONSTRUCTION AND TAXABLE PROPERTY VALUES
LAST TEN YEARS**

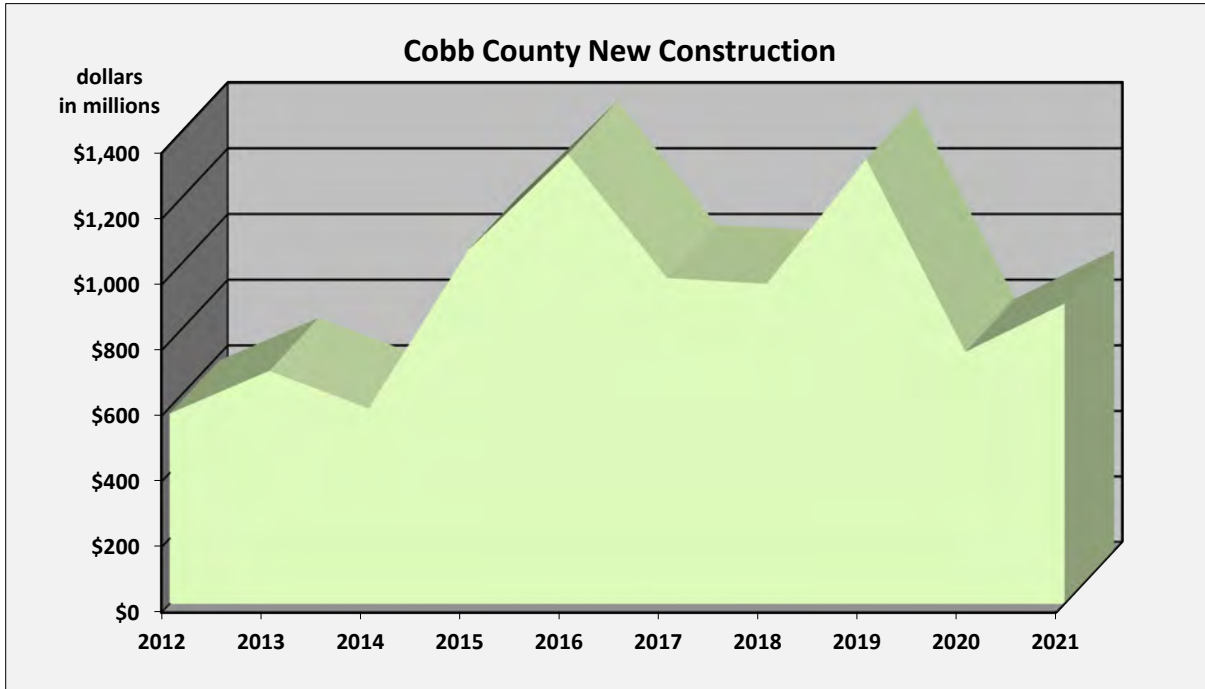

(dollars expressed in millions)

Calendar Year Ended	Bank Deposits (a)	Single-Family Residences (b)		Total New Construction (b)		Estimated Actual Value of Taxable Property (c)
		Number of Units	Market Value	Number of Permits	Market Value	
2012	\$ 10,269	734	\$ 204	5,667	\$ 581	\$ 52,227
2013	10,933	1,077	316	6,320	711	51,004
2014	11,936	938	277	7,352	596	52,775
2015	13,769	923	314	5,596	1,078	54,686
2016	13,797	939	311	5,725	1,371	58,105
2017	15,216	943	290	9,825	994	61,956
2018	15,633	982	297	10,758	976	67,257
2019	18,247	875	257	10,915	1,355	70,924
2020	23,666	891	268	11,537	769	74,435
2021	27,035	909	291	12,271	916	78,742

(a) Bank deposits are supplied by the Federal Deposit Insurance Corporation (FDIC).

(b) New residence and construction data for the 12-month period ended December 31 is supplied by the Cobb County Community Development Agency and is on a calendar-year basis.

(c) Source: Cobb County Tax Commissioner.

**COBB COUNTY SCHOOL DISTRICT
PROPERTY DIGEST REDUCTIONS DUE TO EXEMPTIONS
LAST TEN FISCAL YEARS**

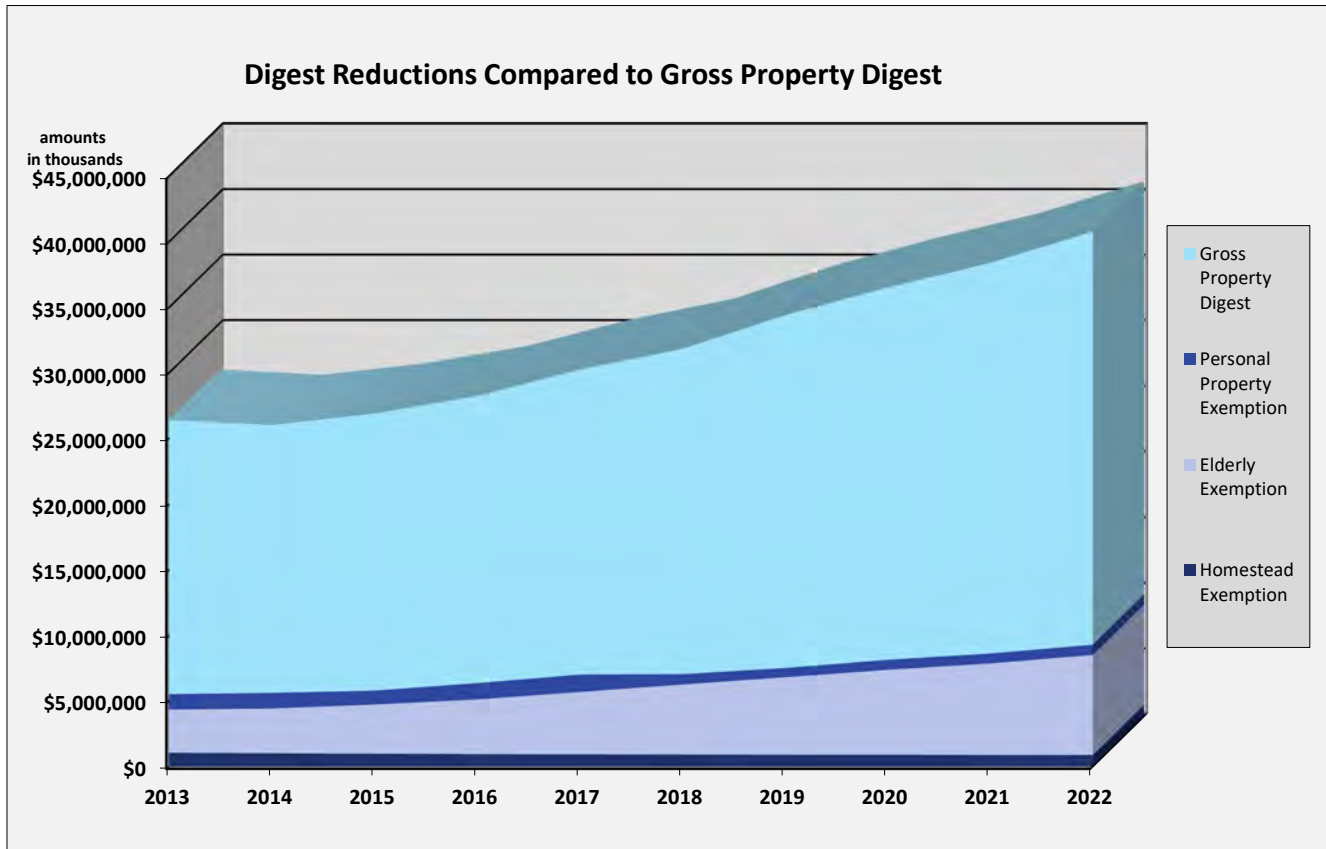

(amounts expressed in thousands)

Fiscal Year	Homestead Exemption	Elderly Exemption	Disabled Residents Exemption	Personal Property Exemption	Conservation Exemption	Total Digest Reductions	Gross Property Digest	Reductions as Percent of Gross Digest
2013	\$ 1,041,831	\$ 3,299,172	\$ 15,660	\$ 1,175,141	\$ 52,676	\$ 5,584,480	\$ 26,475,609	21.09%
2014	999,067	3,420,226	16,281	1,196,382	53,574	5,685,530	26,087,102	21.79%
2015	965,937	3,755,620	18,132	1,068,067	53,146	5,860,902	26,970,876	21.73%
2016	935,568	4,177,064	21,587	1,249,680	54,339	6,438,238	28,312,566	22.74%
2017	918,620	4,764,134	26,027	1,330,396	59,702	7,098,879	30,340,771	23.40%
2018	903,943	5,350,772	31,221	793,748	66,325	7,146,009	31,928,409	22.38%
2019	889,782	5,921,610	40,762	704,910	72,640	7,729,704	34,632,393	22.32%
2020	882,981	6,493,656	49,265	769,184	75,071	8,270,157	36,639,839	22.57%
2021	871,131	6,993,577	61,512	761,257	79,256	8,766,733	38,540,928	22.75%
2022	874,301	7,643,479	83,901	779,911	89,526	9,471,118	40,967,959	23.12%

Source: Cobb County Office of Tax Commissioner

**COBB COUNTY SCHOOL DISTRICT
NUMBER OF PERSONNEL AND RATIO OF PUPILS TO PROFESSIONAL PERSONNEL
LAST TEN FISCAL YEARS**

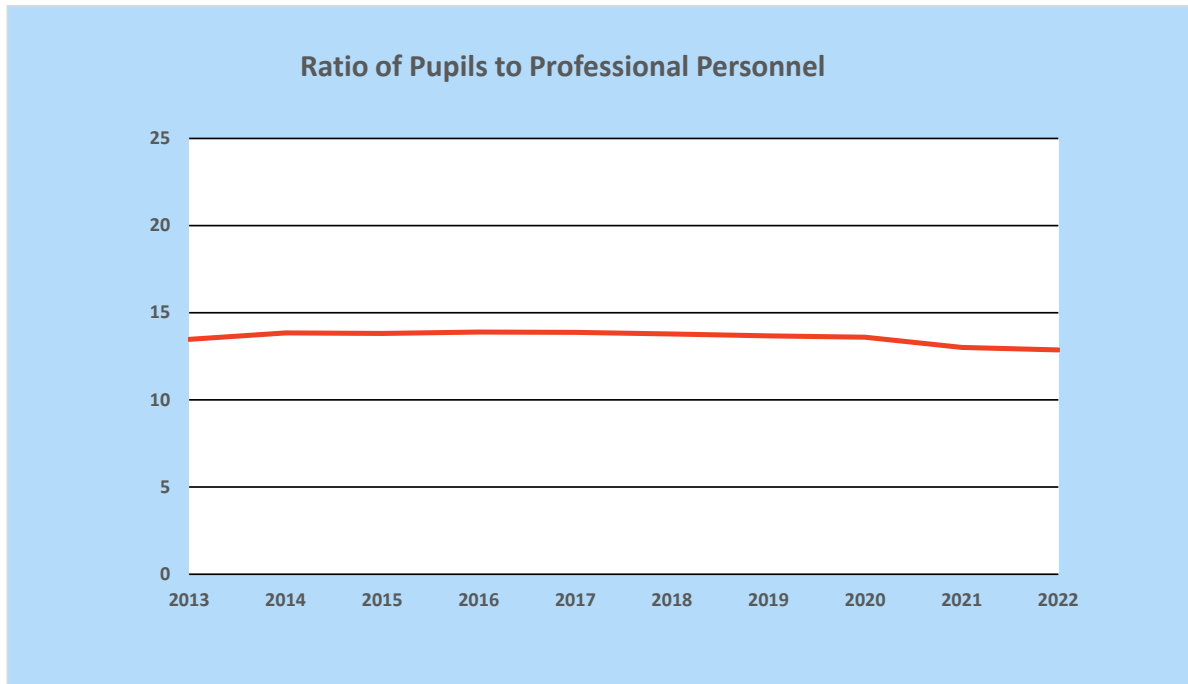

Fiscal Year	Professional Personnel (a)	Other Operating Personnel (b)	Service Personnel (c)	Total Personnel	Active Student Enrollment	Ratio of Pupils to Professional Personnel
2013	8,008	2,896	2,813	13,717	107,914	13.5
2014	7,907	2,821	2,834	13,562	109,529	13.9
2015	8,036	2,769	2,949	13,754	111,060	13.8
2016	8,050	2,943	2,599	13,592	111,848	13.9
2017	8,099	2,953	2,613	13,665	112,412	13.9
2018	8,092	2,587	2,927	13,606	111,482	13.8
2019	8,141	2,604	2,895	13,640	111,386	13.7
2020	8,217	2,932	2,632	13,781	111,760	13.6
2021	8,224	2,888	2,417	13,529	106,983	13.0
2022	8,284	2,872	2,328	13,484	106,601	12.9

(a) Professional personnel consists of all certified personnel including teachers, librarians, counselors, supervisors, consultants, coordinators, principals, assistant principals and other leadership personnel.

(b) Other operating personnel includes non-certified leadership personnel, classroom aides, secretarial and clerical employees, and other technicians.

(c) Service personnel includes food service personnel, custodial employees, bus drivers and maintenance/warehouse employees.

Source: District Records

**COBB COUNTY SCHOOL DISTRICT
OPERATING STATISTICS
LAST TEN FISCAL YEARS**

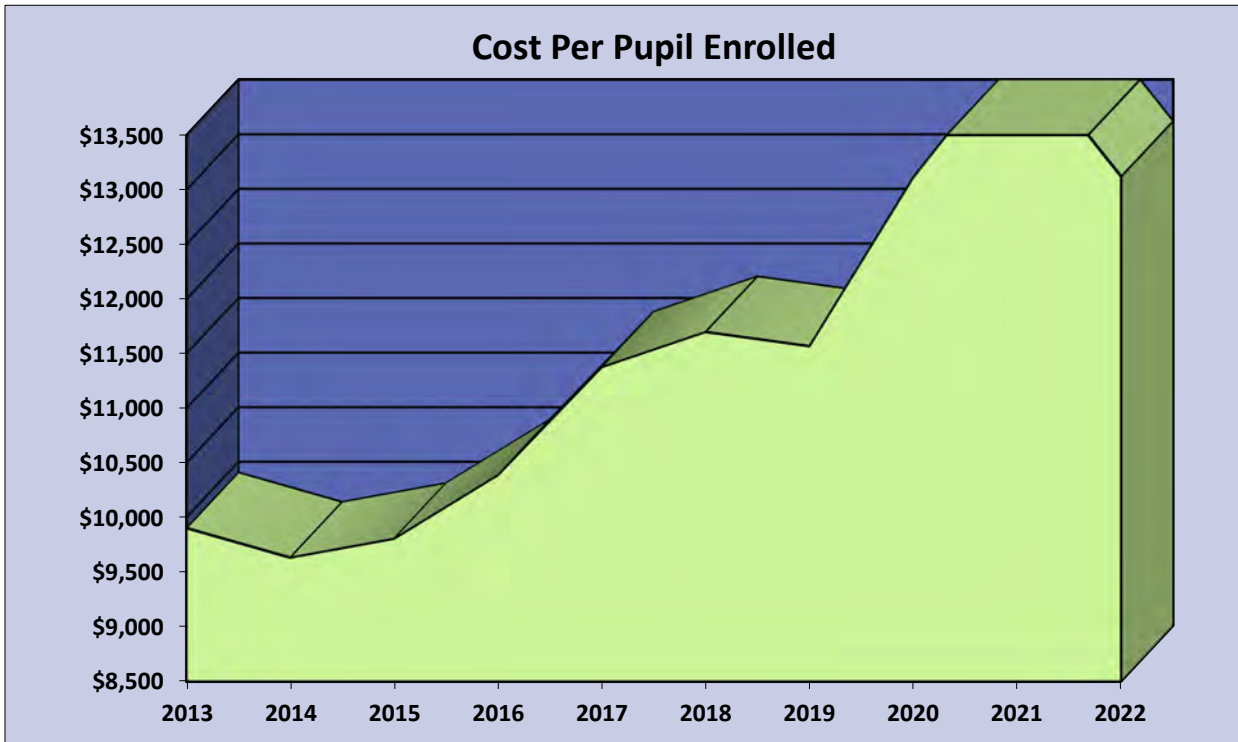

Fiscal Year	Expenses	Active Student Enrollment	Cost Per Pupil Enrolled	Percentage of Change	Professional Personnel	Ratio of Pupils to Professional Personnel
2013	\$ 1,068,484,000	107,914	\$ 9,901	1.83%	8,008	13.5
2014	1,054,860,000	109,529	9,631	-2.73%	7,907	13.9
2015	1,088,719,000	111,060	9,803	1.79%	8,036	13.8
2016	1,161,536,000	111,848	10,385	5.94%	8,050	13.9
2017	1,278,514,000	112,412	11,373	9.52%	8,099	13.9
2018	1,303,932,000	111,482	11,696	2.84%	8,092	13.8
2019	1,288,338,000	111,386	11,566	-1.11%	8,141	13.7
2020	1,465,479,000	111,760	13,113	13.37%	8,217	13.6
2021	1,531,381,000	106,983	14,314	9.16%	8,224	13.0
2022	1,398,684,000	106,601	13,121	-8.34%	8,284	12.9

Note: Professional personnel consists of all certified personnel including teachers, librarians, counselors, supervisors consultants, coordinators, principals, assistant principals and other leadership personnel.

Source: District Records

**COBB COUNTY SCHOOL DISTRICT
GENERAL FUND EXPENDITURES BY FUNCTION
LAST TEN FISCAL YEARS**

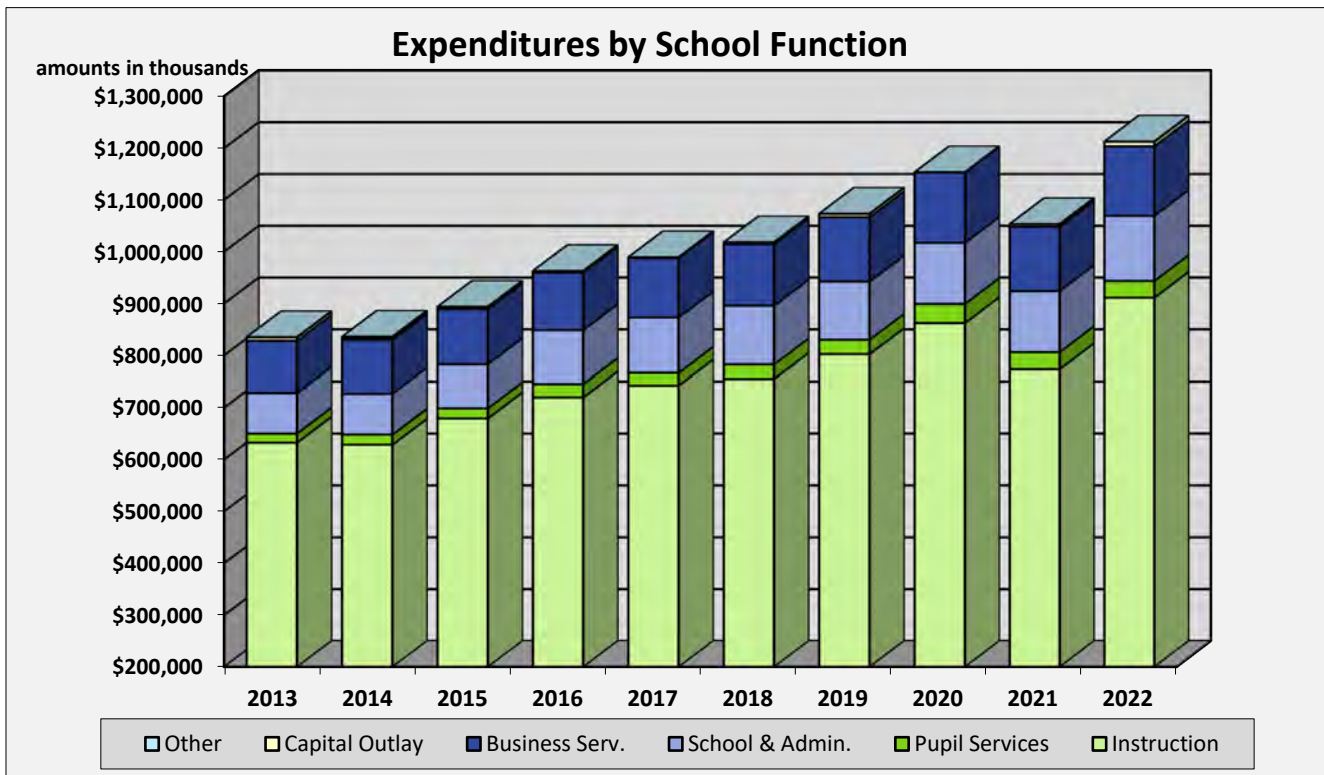

(amounts expressed in thousands)

Fiscal Year	Instruction	Pupil Services	School & Administrative Services	Business Services	Capital Outlay	Other	Total
2013	\$ 632,579	\$ 17,502	\$ 77,821	\$ 100,191	\$ 6,659	\$ -	\$ 834,752
2014	628,652	19,489	78,407	103,311	4,346	1,489	835,694
2015	679,320	19,248	84,588	106,063	3,769	458	893,446
2016	719,560	25,478	103,673	110,845	2,546	465	962,567
2017	742,169	24,385	106,625	114,446	1,510	-	989,135
2018	754,822	27,891	113,283	118,690	3,119	-	1,017,805
2019	802,325	27,645	112,484	124,249	6,474	-	1,073,177
2020	862,210	36,978	117,988	136,059	14	-	1,153,249
2021	773,364	32,845	117,781	124,144	4,926	-	1,053,060
2022	911,194	32,350	125,855	134,239	8,834	-	1,212,472

Instruction includes expenditures for Instruction and Instructional Services.

Business Services includes expenditures for Student Transportation and Maintenance & Operations.

Other includes expenditures for School Nutrition Program and Student Activities.

Source: District Records

**COBB COUNTY SCHOOL DISTRICT
GENERAL FUND REVENUES BY SOURCE
LAST TEN FISCAL YEARS**

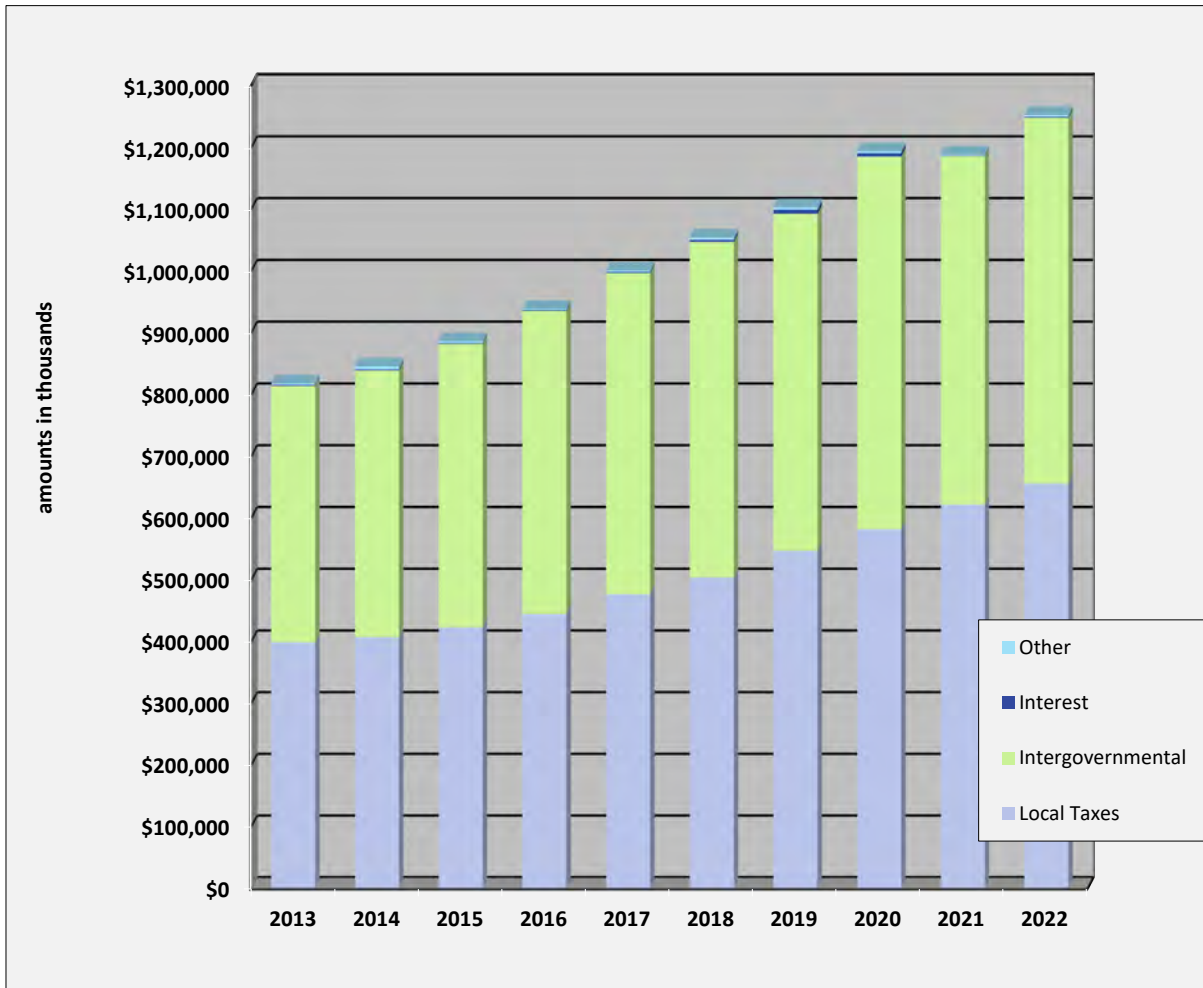

(amounts expressed in thousands)

<u>Fiscal Year</u>	<u>Local Taxes</u>	<u>Intergovernmental</u>	<u>Interest Income</u>	<u>Other</u>	<u>Total</u>
2013	\$ 397,592	\$ 415,168	\$ 1,562	\$ 2,406	\$ 816,728
2014	405,970	431,907	1,637	4,991	844,505
2015	421,814	459,181	1,294	2,935	885,224
2016	443,641	490,747	1,189	1,751	937,328
2017	475,835	519,721	1,662	2,188	999,406
2018	502,801	543,085	3,352	3,801	1,053,039
2019	546,113	545,342	6,473	4,161	1,102,089
2020	580,813	603,286	5,298	3,346	1,192,743
2021	620,701	564,352	651	1,519	1,187,223
2022	654,791	592,212	1,456	2,836	1,251,295

Other includes Tuition & Fees, Insurance & Damage Recoveries, Rentals and Other Revenues.

Source: District Records

**COBB COUNTY SCHOOL DISTRICT
RATIO OF ANNUAL DEBT SERVICE EXPENDITURES FOR GENERAL BONDED DEBT
TO TOTAL GENERAL EXPENDITURES
LAST TEN FISCAL YEARS**

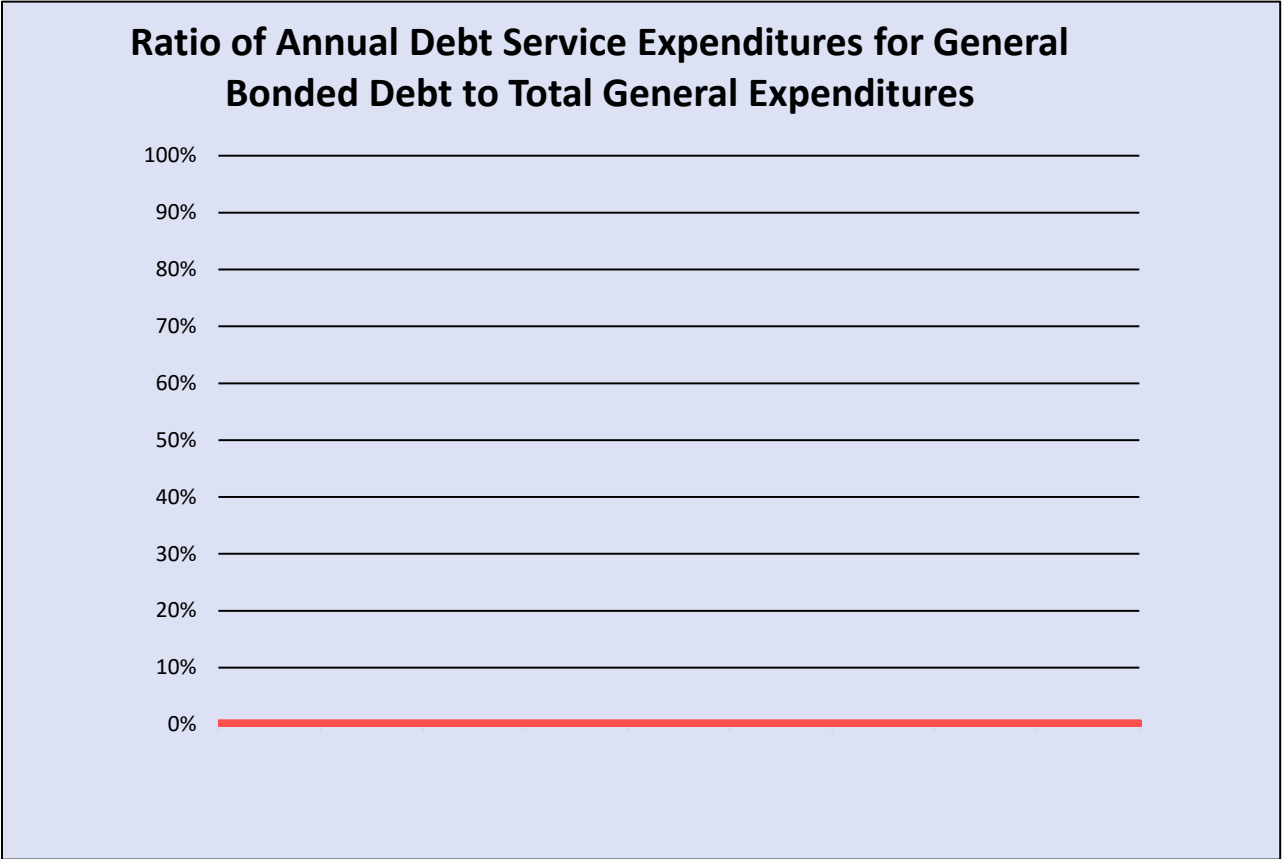

<u>Fiscal Year</u>	<u>Debt Service Fund Expenditures</u>	<u>General Fund Expenditures</u>	<u>Ratio of Debt Service Fund to General Fund Expenditures</u>
2013	-	\$ 834,752,000	0.00%
2014	-	835,694,000	0.00%
2015	-	893,446,000	0.00%
2016	-	962,567,000	0.00%
2017	-	989,135,000	0.00%
2018	-	1,017,805,000	0.00%
2019	-	1,073,177,000	0.00%
2020	-	1,153,249,000	0.00%
2021	-	1,053,060,000	0.00%
2022	-	1,212,472,000	0.00%

Source: District Records

**COBB COUNTY SCHOOL DISTRICT
RESULTS OF ALL BOND AND SALES TAX REFERENDUMS
1950 TO PRESENT**

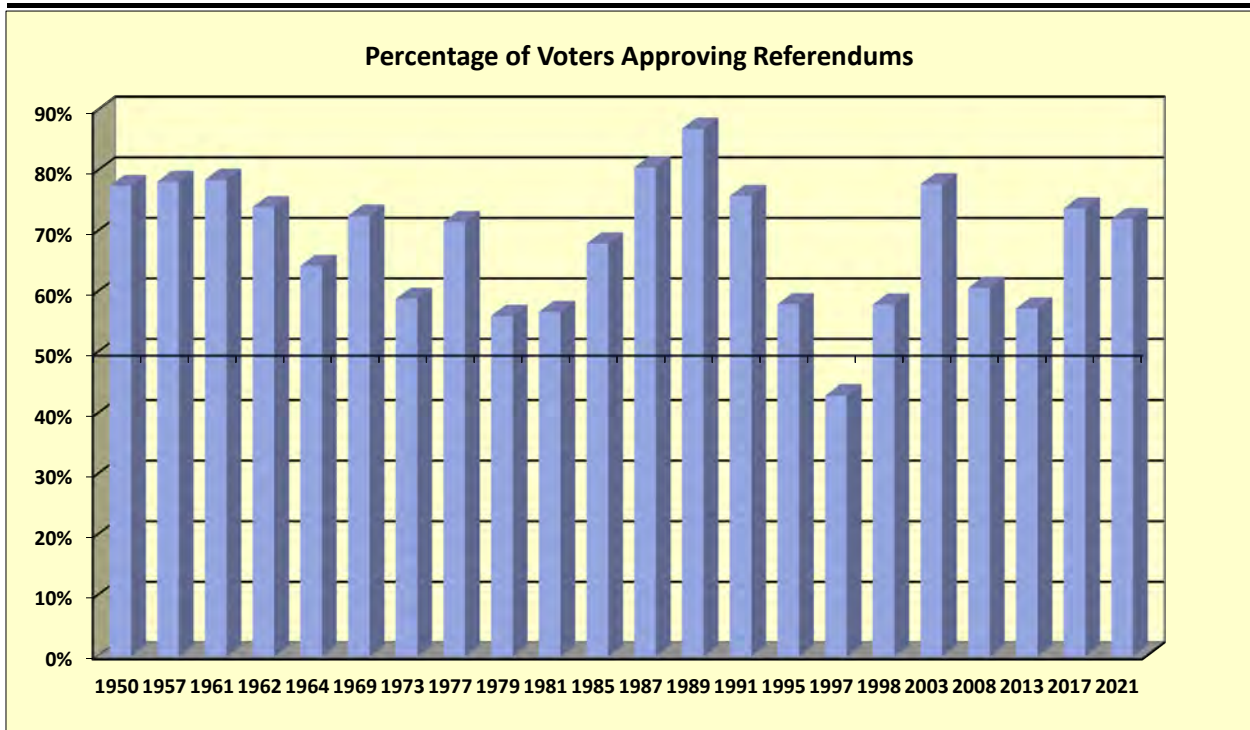

Referendums:

Year	Amount	Maturity	Action	Pro	Con	Void	Total Votes	Approval Percentage
1950	\$ 1,500,000	1970	Passed	2,907	841	17	3,765	77.56%
1957	1,750,000	1977	Passed	2,023	562	31	2,616	78.26%
1961	2,500,000	1980	Passed	3,187	868	38	4,093	78.59%
1962	3,000,000	1983	Passed	2,816	986	36	3,838	74.07%
1964	4,000,000	1994	Passed	2,942	1,629	63	4,634	64.36%
1969	15,000,000	1990	Passed	7,769	2,922	5	10,696	72.67%
1973	16,500,000	1994	Passed	7,405	5,165	10	12,580	58.91%
1977	22,000,000	1996	Passed	10,694	4,241	22	14,957	71.60%
1979	20,000,000	1997	Passed	9,725	7,611	219	17,555	56.10%
1981	8,000,000	1997	Passed	9,858	7,511	103	17,472	56.76%
1985	27,000,000	1997	Passed	24,476	11,481	-	35,957	68.07%
1987	58,500,000	2001	Passed	10,716	2,573	65	13,354	80.64%
1989	59,500,000	2002	Passed	15,510	2,311	126	17,947	87.03%
1991	39,600,000	2004	Passed	20,197	6,409	268	26,874	75.91%
1995	220,865,000	2007	Passed	18,140	13,124	142	31,406	58.02%
1997	609,200,000	2002	Failed	14,204	18,820	177	33,201	43.01%
1998	626,773,000	2003	Passed	36,433	26,403	545	63,381	57.98%
2003	636,504,000	2008	Passed	36,078	10,262	-	46,340	77.85%
2008	797,657,000	2013	Passed	21,873	14,137	-	36,010	60.74%
2013	717,845,000	2018	Passed	23,273	17,325	44	40,642	57.33%
2017	797,022,000	2023	Passed	25,160	8,902	44	34,106	73.87%
2021	894,891,000	2028	Passed	35,466	13,723	-	49,189	72.10%

Note: 1997, 1998, 2003, 2008, 2013, 2017 and 2021 referendums were for a 1% local option sales tax with the amounts shown representing an estimate of collections for the full five year life of the tax.
Source: Cobb County Board of Elections.

**COBB COUNTY SCHOOL DISTRICT
SCHOOL BUILDINGS
LAST TEN FISCAL YEARS**

<u>School Name</u>	<u>2013</u>	<u>2014</u>	<u>2015</u>	<u>2016</u>	<u>2017</u>	<u>2018</u>	<u>2019</u>	<u>2020</u>	<u>2021</u>	<u>2022</u>
Acworth Intermediate (2001)										
Square Feet	131,924	131,924	131,924	131,924	131,924	131,924	131,924	131,924	131,924	131,924
Capacity	913	913	913	913	913	913	913	925	925	925
Enrollment	832	776	732	697	717	671	662	639	570	550
Addison (1989)										
Square Feet	81,334	81,334	81,334	81,334	81,334	81,334	81,334	81,334	81,334	81,334
Capacity	662	662	662	662	662	662	662	662	662	662
Enrollment	596	587	615	619	610	631	604	635	598	622
Argyle (1961)										
Square Feet	56,238	56,904	56,904	56,904	56,904	56,904	56,904	56,904	56,904	56,904
Capacity	537	537	537	537	537	537	537	562	562	562
Enrollment	641	480	454	410	452	427	364	369	345	302
Austell (2005)										
Square Feet	85,236	85,236	85,236	85,236	85,236	85,236	85,236	85,236	85,236	85,236
Capacity	562	562	562	562	562	562	562	562	562	562
Enrollment	470	532	553	569	518	486	464	469	421	406
Baker (1988)										
Square Feet	106,694	106,694	106,694	106,694	106,694	106,694	106,694	106,694	106,694	106,694
Capacity	987	987	987	987	987	987	987	1,025	1,025	1,025
Enrollment	761	756	782	774	789	791	863	871	792	784
Bells Ferry (1963)										
Square Feet	83,098	83,098	83,098	83,098	83,098	83,098	83,098	83,098	83,098	83,098
Capacity	712	712	712	712	712	712	712	737	712	737
Enrollment	585	593	738	702	697	717	768	751	742	730
Belmont Hills (1952)										
Square Feet	68,409	68,409	68,409	68,409	68,409	68,409	68,409	68,409	68,409	68,409
Capacity	562	562	562	562	562	562	562	562	562	562
Enrollment	481	307	360	340	356	348	358	355	334	309
Big Shanty (1968)										
Square Feet	84,461	84,461	84,461	84,461	84,461	84,461	84,461	84,461	84,461	84,461
Capacity	837	837	837	837	837	837	837	837	837	837
Enrollment	759	771	753	702	617	600	530	520	525	515
Birney (1973)										
Square Feet	105,886	105,886	105,886	105,886	105,886	105,886	105,886	105,886	105,886	105,886
Capacity	912	912	912	912	912	912	912	925	925	925
Enrollment	768	775	732	792	893	854	822	777	710	662
Blackwell (1998)										
Square Feet	111,299	111,299	111,299	111,299	111,299	111,299	111,299	111,299	111,299	111,299
Capacity	837	837	837	837	837	837	837	837	837	837
Enrollment	703	730	723	721	744	747	697	743	652	627
Brown (1955)										
Square Feet	49,828	49,828	49,828	49,828	49,828	49,828	49,828	49,828	49,828	49,828
Capacity	412	412	412	412	412	412	412	412	412	412
Enrollment	285	-	-	-	-	-	-	-	-	-
Brumby (1966)										
Square Feet	99,181	99,181	99,181	99,181	99,181	99,181	-	-	-	-
Capacity	912	912	912	912	912	912	-	-	-	-
Enrollment	1,000	1,051	1,024	1,002	942	910	-	-	-	-
Brumby Replacement (2018)										
Square Feet	-	-	-	-	-	-	168,576	168,576	168,576	168,576
Capacity	-	-	-	-	-	-	1,062	1,162	1,162	1,162
Enrollment	-	-	-	-	-	-	942	962	903	948
Bryant (1991)										
Square Feet	116,071	116,071	116,071	116,071	116,071	116,071	116,071	116,071	116,071	116,071
Capacity	962	962	962	962	962	962	962	962	962	962
Enrollment	962	953	980	993	1,015	1,013	1,031	977	886	854
Bullard (2003)										
Square Feet	136,261	136,261	136,261	136,261	136,261	136,261	136,261	136,261	136,261	136,261
Capacity	987	987	987	987	987	987	987	987	987	987
Enrollment	933	894	910	873	805	835	827	838	756	780
Chalker (1997)										
Square Feet	124,148	124,148	124,148	124,148	124,148	124,148	124,148	124,148	124,148	124,148
Capacity	963	963	963	963	963	963	963	975	975	975
Enrollment	683	675	707	673	656	644	673	686	653	659

**COBB COUNTY SCHOOL DISTRICT
SCHOOL BUILDINGS
LAST TEN FISCAL YEARS**

<u>School Name</u>	<u>2013</u>	<u>2014</u>	<u>2015</u>	<u>2016</u>	<u>2017</u>	<u>2018</u>	<u>2019</u>	<u>2020</u>	<u>2021</u>	<u>2022</u>
Cheatham Hill (1997)										
Square Feet	137,108	137,108	137,108	137,108	137,108	137,108	137,108	137,108	137,108	137,108
Capacity	1,063	1,063	1,063	1,063	1,063	1,063	1,063	1,063	1,063	1,063
Enrollment	1,149	1,112	1,094	1,110	1,131	1,116	1,087	1,110	1,028	1,022
City View (f)(Riverside Intermediate)										
Square Feet	123,000	123,000	123,000	123,000	123,000	123,000	123,000	123,000	123,000	123,000
Capacity	962	962	962	962	962	962	962	962	962	962
Enrollment	1,107	1,101	1,182	1,220	1,221	1,147	1,109	1,049	923	848
Clarkdale Replacement (2012)										
Square Feet	129,988	129,988	129,988	129,988	129,988	129,988	129,988	129,988	129,988	129,988
Capacity	862	862	862	862	863	863	863	887	887	887
Enrollment	587	631	724	726	798	813	811	792	745	688
Clay (1961)										
Square Feet	55,412	55,412	55,412	55,412	55,412	55,412	55,412	55,412	55,412	55,412
Capacity	437	437	437	437	437	437	437	450	450	450
Enrollment	351	381	396	407	395	391	406	387	-	-
Clay-Harmony Leland (2021)										
Square Feet	-	-	-	-	-	-	-	-	186,930	186,930
Capacity	-	-	-	-	-	-	-	-	1,212	1,250
Enrollment	-	-	-	-	-	-	-	-	952	926
Compton (1969)										
Square Feet	99,427	99,427	99,427	99,427	88,079	88,079	88,079	88,079	88,079	88,079
Capacity	937	937	937	937	788	788	788	800	800	800
Enrollment	556	559	590	576	559	546	497	526	538	564
Davis (1987)										
Square Feet	86,131	86,131	86,131	86,131	86,131	86,131	86,131	86,131	86,131	86,131
Capacity	788	788	788	788	788	788	788	800	800	800
Enrollment	559	584	578	568	572	573	608	602	576	614
Dowell (1989)										
Square Feet	106,003	106,003	106,003	106,003	106,003	106,003	106,003	106,003	106,003	106,003
Capacity	963	963	963	963	963	963	963	975	975	975
Enrollment	968	922	942	1,013	973	980	992	980	889	860
Due West (1957)										
Square Feet	70,367	70,367	70,367	70,367	70,367	70,367	70,367	70,367	70,367	70,367
Capacity	587	587	587	587	587	587	587	600	600	600
Enrollment	547	594	626	627	635	617	576	588	570	603
East Side Replacement (2011)										
Square Feet	149,764	149,764	149,764	149,764	149,764	149,764	149,764	149,764	149,764	149,764
Capacity	1,087	1,087	1,087	1,087	1,087	1,087	1,087	1,087	1,087	1,087
Enrollment	1,221	1,304	1,268	1,266	1,298	1,288	1,256	1,226	1,159	1,157
Eastvalley (1960)										
Square Feet	60,029	60,029	60,029	60,029	60,029	60,029	60,029	60,029	60,029	60,029
Capacity	562	562	562	562	562	562	562	562	562	562
Enrollment	661	692	691	693	720	727	709	800	700	687
Fair Oaks (1957)										
Square Feet	97,993	97,993	97,993	97,993	97,993	97,993	97,993	97,993	97,993	97,993
Capacity	863	863	863	863	863	863	863	875	875	875
Enrollment	831	898	960	956	961	894	841	820	761	770
Ford (1991)										
Square Feet	91,129	91,129	91,129	91,129	91,129	91,129	91,129	91,129	91,129	91,129
Capacity	862	862	862	862	862	862	862	862	862	862
Enrollment	713	681	717	723	805	838	842	890	798	781
Frey (1996)										
Square Feet	125,717	125,717	125,717	125,717	125,717	125,717	125,717	125,717	125,717	125,717
Capacity	963	963	963	963	963	963	963	975	975	975
Enrollment	737	742	746	783	817	805	830	852	734	757
Garrison Mill (1984)										
Square Feet	85,775	85,775	85,775	85,775	85,775	85,775	85,775	85,775	85,775	85,775
Capacity	688	688	688	688	688	688	688	700	700	700
Enrollment	716	675	690	672	674	698	699	700	646	674

continued-

**COBB COUNTY SCHOOL DISTRICT
SCHOOL BUILDINGS
LAST TEN FISCAL YEARS**

<u>School Name</u>	<u>2013</u>	<u>2014</u>	<u>2015</u>	<u>2016</u>	<u>2017</u>	<u>2018</u>	<u>2019</u>	<u>2020</u>	<u>2021</u>	<u>2022</u>
Green Acres (1996)										
Square Feet	90,915	90,915	90,915	90,915	90,915	90,915	90,915	90,915	90,915	90,915
Capacity	688	688	688	688	688	688	688	700	700	700
Enrollment	866	767	732	737	706	704	628	603	592	592
Harmony Leland (1951)										
Square Feet	65,127	65,127	65,127	65,127	65,127	65,127	65,127	65,127	65,127	65,127
Capacity	512	512	512	512	512	512	512	512	512	512
Enrollment	678	699	721	686	672	642	616	605	-	-
Hayes (1993)										
Square Feet	119,189	119,189	119,189	119,189	119,189	119,189	119,189	119,189	119,189	119,189
Capacity	962	962	962	962	962	962	962	962	962	962
Enrollment	985	961	934	883	850	900	923	958	893	828
Hendricks (2001)										
Square Feet	123,025	123,025	123,025	123,025	123,025	123,025	123,025	123,025	123,025	123,025
Capacity	962	962	962	962	962	962	962	962	962	962
Enrollment	584	531	529	568	584	645	585	590	555	483
Hollydale (1968)										
Square Feet	89,012	89,012	89,012	89,012	89,012	89,012	89,012	89,012	89,012	89,012
Capacity	862	862	862	862	862	862	862	862	862	862
Enrollment	693	693	687	667	649	616	615	593	571	556
Keheley (1986)										
Square Feet	70,537	70,537	70,537	70,537	70,537	70,537	70,537	70,537	70,537	70,537
Capacity	588	588	588	588	588	588	588	600	600	600
Enrollment	473	484	538	529	508	509	489	479	400	414
Kemp (2002)										
Square Feet	123,000	123,000	123,000	123,000	123,000	123,000	123,000	123,000	123,000	123,000
Capacity	962	962	962	962	962	962	962	962	962	962
Enrollment	964	1,031	1,035	995	953	988	972	955	888	898
Kennesaw (1991)										
Square Feet	116,400	116,400	116,400	116,400	116,400	116,400	116,400	116,400	116,400	116,400
Capacity	962	962	962	962	962	962	962	975	975	975
Enrollment	714	712	667	639	601	627	652	654	619	584
Kincaid (1972)										
Square Feet	83,969	83,969	83,969	83,969	83,969	83,969	83,969	83,969	83,969	83,969
Capacity	762	762	762	762	762	762	762	762	762	762
Enrollment	730	740	726	702	699	714	683	672	605	577
King Springs (1956)										
Square Feet	59,658	59,658	59,658	59,658	59,658	59,658	59,658	59,658	-	-
Capacity	587	587	587	587	587	587	587	587	-	-
Enrollment	792	832	859	913	944	1,047	1,097	1,083	-	-
King Springs Replacement (2021)										
Square Feet	-	-	-	-	-	-	-	-	162,621	154,696
Capacity	-	-	-	-	-	-	-	-	1,237	1,050
Enrollment	-	-	-	-	-	-	-	-	1,066	1,034
LaBelle (1955)										
Square Feet	82,912	82,912	82,912	82,912	82,912	82,912	82,912	82,912	82,912	82,912
Capacity	688	688	688	688	688	688	688	700	700	700
Enrollment	476	576	539	530	480	430	438	432	354	357
Lewis (1986)										
Square Feet	115,363	115,363	115,363	115,363	115,363	115,363	115,363	115,363	115,363	115,363
Capacity	962	962	962	962	962	962	962	962	962	962
Enrollment	749	763	703	656	597	547	556	568	557	535
Mableton (2012)										
Square Feet	148,523	148,523	148,523	148,523	148,523	148,523	148,523	148,523	148,523	148,523
Capacity	962	962	962	962	962	962	962	962	962	962
Enrollment	943	950	953	1,023	1,064	1,034	1,047	1,045	994	915
McCall Primary (2005)										
Square Feet	88,158	88,158	88,158	88,158	88,158	88,158	88,158	88,158	88,158	88,158
Capacity	562	562	562	562	562	562	562	512	512	512
Enrollment	431	407	396	407	375	360	359	346	311	272

**COBB COUNTY SCHOOL DISTRICT
SCHOOL BUILDINGS
LAST TEN FISCAL YEARS**

<u>School Name</u>	<u>2013</u>	<u>2014</u>	<u>2015</u>	<u>2016</u>	<u>2017</u>	<u>2018</u>	<u>2019</u>	<u>2020</u>	<u>2021</u>	<u>2022</u>
Milford (1954)										
Square Feet	73,352	73,352	73,352	73,352	73,352	73,352	73,352	73,352	73,352	73,352
Capacity	612	612	612	612	612	612	612	637	637	637
Enrollment	559	466	458	467	461	424	374	356	372	351
Mount Bethel (1978)										
Square Feet	110,096	110,096	110,096	110,096	110,096	110,096	110,096	110,096	110,096	110,096
Capacity	937	937	937	937	937	937	937	937	937	937
Enrollment	984	1,011	1,040	1,119	1,132	1,118	1,122	1,100	983	996
Mountain View (1986)										
Square Feet	102,725	102,725	102,725	102,725	102,725	144,362	144,362	144,362	144,362	144,362
Capacity	887	887	887	887	887	962	962	962	962	962
Enrollment	840	837	853	837	755	772	848	857	781	772
Murdock (1975)										
Square Feet	123,233	123,233	123,233	123,233	123,233	123,233	123,233	123,233	123,233	123,233
Capacity	962	962	962	962	962	962	962	962	962	962
Enrollment	830	859	896	937	1,019	1,012	973	1,002	932	955
Nicholson (1990)										
Square Feet	75,800	75,800	75,800	75,800	75,800	75,800	75,800	75,800	75,800	75,800
Capacity	637	637	637	637	637	637	637	637	637	637
Enrollment	511	500	516	544	538	534	520	492	441	413
Nickajack (1998)										
Square Feet	122,342	122,342	122,342	122,342	122,342	122,342	122,342	122,342	122,342	122,342
Capacity	937	937	937	937	937	937	937	937	937	937
Enrollment	1,055	1,130	1,115	1,054	1,068	1,104	1,151	1,186	1,126	1,116
Norton Park (1961)										
Square Feet	87,935	87,935	87,935	87,935	87,935	87,935	87,935	87,935	87,935	87,935
Capacity	837	837	837	837	837	837	837	837	837	837
Enrollment	788	808	916	950	917	901	870	827	751	701
Pickett's Mill (2008)										
Square Feet	139,090	139,090	139,090	139,090	139,090	139,090	139,090	139,090	139,090	139,090
Capacity	963	963	963	963	987	987	987	987	987	987
Enrollment	723	736	750	732	761	764	751	755	679	689
Pitner (2003)										
Square Feet	136,261	136,261	136,261	136,261	136,261	136,261	136,261	136,261	136,261	136,261
Capacity	962	962	962	962	962	962	962	962	962	962
Enrollment	937	909	888	892	966	913	876	877	766	767
Powder Springs (1988)										
Square Feet	101,870	101,870	101,870	101,870	101,870	101,870	101,870	101,870	101,870	101,870
Capacity	888	888	888	888	888	888	888	900	900	900
Enrollment	783	807	824	815	838	777	770	801	791	789
Powers Ferry (1951)										
Square Feet	59,190	59,190	59,190	59,190	59,190	59,190	59,190	59,190	59,190	59,190
Capacity	462	462	462	462	462	462	462	462	462	462
Enrollment	467	448	436	446	437	482	464	414	402	402
Riverside Primary (2005)										
Square Feet	85,236	85,236	85,236	85,236	85,236	85,236	85,236	85,236	85,236	85,236
Capacity	562	562	562	562	562	562	562	562	562	562
Enrollment	681	710	671	639	613	534	551	537	551	521
Rocky Mount (1977)										
Square Feet	71,408	71,408	72,896	72,896	72,896	72,896	72,896	72,896	72,896	72,896
Capacity	612	612	612	612	612	612	612	612	612	612
Enrollment	614	602	622	613	584	610	595	614	547	569
Russell (1961)										
Square Feet	103,369	104,362	104,362	104,362	104,362	104,362	104,362	104,362	104,362	104,362
Capacity	962	962	962	962	962	962	962	962	962	962
Enrollment	728	704	697	699	688	666	648	638	573	552
Sanders (1997)										
Square Feet	116,302	116,302	116,302	116,302	116,302	116,302	116,302	116,302	116,302	116,302
Capacity	862	862	862	862	862	862	862	862	862	862
Enrollment	829	809	827	774	747	732	727	693	693	633
Sedalia Park (1956)										
Square Feet	99,735	99,735	99,735	99,735	99,735	99,735	99,735	99,735	99,735	99,735
Capacity	888	888	888	888	912	912	912	912	912	912
Enrollment	828	815	845	866	868	850	755	739	652	619

continued-

**COBB COUNTY SCHOOL DISTRICT
SCHOOL BUILDINGS
LAST TEN FISCAL YEARS**

<u>School Name</u>	<u>2013</u>	<u>2014</u>	<u>2015</u>	<u>2016</u>	<u>2017</u>	<u>2018</u>	<u>2019</u>	<u>2020</u>	<u>2021</u>	<u>2022</u>
Shallowford Falls (1990)										
Square Feet	112,620	112,620	112,620	112,620	112,620	112,620	112,620	112,620	112,620	112,620
Capacity	962	962	962	962	962	962	962	962	962	962
Enrollment	658	654	669	640	663	713	728	684	592	615
Smyrna (2013)										
Square Feet	-	143,107	143,107	143,107	143,107	143,107	143,107	143,107	143,107	143,107
Capacity	-	962	962	962	962	962	962	962	962	962
Enrollment	-	863	954	962	991	1,004	1,051	1,028	942	914
Sope Creek (1978)										
Square Feet	133,344	133,344	133,344	133,344	133,344	133,344	133,344	133,344	133,344	133,344
Capacity	1,162	1,162	1,162	1,162	1,162	1,162	1,162	1,162	1,162	1,162
Enrollment	1,157	1,181	1,150	1,164	1,166	1,216	1,165	1,178	1,020	1,061
Still (1978)										
Square Feet	116,074	116,074	117,539	117,539	117,539	117,539	117,539	117,539	117,539	117,539
Capacity	963	963	963	963	963	963	963	975	975	975
Enrollment	768	814	789	784	783	768	756	769	744	747
Teasley (1961)										
Square Feet	55,944	55,944	52,764	107,837	108,100	108,100	108,100	108,100	108,100	108,100
Capacity	487	487	487	812	837	837	837	837	837	837
Enrollment	718	720	777	804	874	871	892	952	923	935
Timber Ridge (1990)										
Square Feet	73,450	73,450	73,450	73,450	73,450	73,450	73,450	73,450	73,450	73,450
Capacity	612	612	612	612	612	612	612	612	612	612
Enrollment	615	610	612	616	606	573	563	575	495	489
Tritt (1979)										
Square Feet	109,769	109,769	109,769	109,769	109,769	109,769	109,769	109,769	109,769	109,769
Capacity	937	937	937	937	937	937	937	937	937	937
Enrollment	926	918	900	907	912	906	915	920	826	817
Varner (1990)										
Square Feet	109,827	109,827	109,827	109,827	109,827	109,827	109,827	109,827	109,827	109,827
Capacity	962	962	962	962	963	963	963	975	975	975
Enrollment	742	703	674	714	719	787	789	876	818	746
Vaughan (1996)										
Square Feet	122,260	122,260	122,260	122,260	122,260	122,260	122,260	122,260	122,260	122,260
Capacity	937	937	937	937	937	937	937	937	937	937
Enrollment	676	659	690	666	722	772	764	735	652	647
Awtrey (1965)										
Square Feet	156,660	156,660	156,660	156,660	156,660	156,660	156,660	156,660	156,660	156,660
Capacity	1,037	1,037	1,037	1,037	1,037	1,037	1,037	1,037	1,037	1,037
Enrollment	848	850	823	838	861	818	794	729	701	649
Barber (2005)										
Square Feet	178,465	178,465	178,465	178,465	178,465	178,465	178,465	178,465	178,465	178,465
Capacity	1,162	1,162	1,162	1,162	1,162	1,162	1,162	1,162	1,162	1,162
Enrollment	966	979	938	936	903	915	922	894	915	864
Campbell (1951)										
Square Feet	207,172	220,228	220,228	220,228	220,228	220,228	220,228	220,228	220,228	220,228
Capacity	1,338	1,338	1,338	1,338	1,338	1,338	1,338	1,437	1,437	1,437
Enrollment	1,278	1,286	1,409	1,407	1,426	1,495	1,552	1,619	1,619	1,191
Cooper (2001)										
Square Feet	170,905	170,905	170,905	170,905	170,905	170,905	170,905	170,905	170,905	170,905
Capacity	1,162	1,162	1,162	1,162	1,162	1,162	1,162	1,162	1,162	1,162
Enrollment	942	936	939	942	1,001	1,044	1,068	1,122	1,066	1,055
Daniell (1966)										
Square Feet	177,356	177,356	177,356	177,356	177,356	177,356	177,356	177,356	177,356	177,356
Capacity	1,163	1,163	1,163	1,163	1,163	1,163	1,163	1,175	1,175	1,175
Enrollment	977	978	962	945	989	1,055	1,068	1,017	979	930
Dickerson (1981)										
Square Feet	166,048	166,048	166,048	166,048	166,048	166,048	166,048	166,048	166,048	166,048
Capacity	1,187	1,187	1,187	1,187	1,187	1,187	1,187	1,187	1,187	1,187
Enrollment	1,212	1,237	1,254	1,271	1,271	1,293	1,315	1,305	1,273	1,200

**COBB COUNTY SCHOOL DISTRICT
SCHOOL BUILDINGS
LAST TEN FISCAL YEARS**

<u>School Name</u>	<u>2013</u>	<u>2014</u>	<u>2015</u>	<u>2016</u>	<u>2017</u>	<u>2018</u>	<u>2019</u>	<u>2020</u>	<u>2021</u>	<u>2022</u>
Dodgen (1975)										
Square Feet	183,798	183,798	183,798	183,798	183,798	183,798	183,798	183,798	183,798	183,798
Capacity	1,212	1,212	1,212	1,212	1,212	1,212	1,212	1,187	1,187	1,187
Enrollment	1,185	1,157	1,227	1,249	1,268	1,242	1,261	1,294	1,235	1,210
Durham (1998)										
Square Feet	173,487	173,487	173,487	173,487	173,487	173,487	173,487	173,487	173,487	173,487
Capacity	1,162	1,162	1,162	1,162	1,162	1,162	1,162	1,162	1,162	1,162
Enrollment	1,093	1,025	1,058	1,030	1,061	1,039	1,101	1,104	1,076	999
East Cobb (1963)										
Square Feet	186,961	186,961	186,961	186,961	186,961	186,961	222,963	222,963	222,963	222,963
Capacity	1,362	1,362	1,362	1,362	1,362	1,362	1,387	1,387	1,387	1,387
Enrollment	1,273	1,310	1,243	1,225	1,198	1,284	1,392	1,495	1,444	1,323
Floyd (1964)										
Square Feet	166,551	166,551	166,551	166,551	166,551	166,551	166,551	166,551	166,551	166,551
Capacity	1,112	1,112	1,112	1,112	1,112	1,112	1,112	1,112	1,112	1,112
Enrollment	865	969	933	943	933	930	968	974	972	881
Garrett (1972)										
Square Feet	152,212	152,212	152,212	152,212	152,212	152,212	152,212	152,212	152,212	152,212
Capacity	963	963	963	963	963	963	963	975	975	975
Enrollment	854	779	838	916	885	876	895	963	1,004	936
Griffin (1972)										
Square Feet	186,947	186,947	186,947	186,947	186,947	186,947	186,947	186,947	186,947	186,947
Capacity	1,162	1,162	1,162	1,162	1,162	1,162	1,162	1,137	1,137	1,137
Enrollment	1,154	1,201	1,180	1,237	1,282	1,379	1,415	1,465	1,466	954
Hightower Trail (1993)										
Square Feet	149,038	149,038	149,038	149,038	149,038	149,038	149,038	149,038	149,038	149,038
Capacity	1,012	1,012	1,012	1,012	1,012	1,012	1,012	1,012	1,012	1,012
Enrollment	992	1,014	1,068	1,076	1,125	1,074	1,063	1,070	1,034	1,025
Lindley 6th Grade Academy (1962)										
Square Feet	111,260	111,260	111,260	111,260	111,260	111,260	111,260	111,260	111,260	111,260
Capacity	788	788	788	788	788	788	788	700	700	700
Enrollment	542	589	530	532	501	584	620	629	596	534
Lindley (2001)										
Square Feet	179,170	179,170	179,170	179,170	179,170	179,170	179,170	179,170	179,170	179,170
Capacity	1,162	1,162	1,162	1,162	1,162	1,162	1,162	1,162	1,162	1,162
Enrollment	1,072	1,089	1,161	1,139	1,005	1,022	1,112	1,180	1,207	1,154
Lost Mountain (1992)										
Square Feet	165,107	165,107	165,107	165,107	165,107	165,107	165,107	165,107	165,107	165,107
Capacity	1,137	1,137	1,137	1,137	1,137	1,137	1,137	1,137	1,137	1,137
Enrollment	939	943	962	1,058	1,103	1,090	1,051	1,066	1,028	991
Lovinggood (2006)										
Square Feet	175,345	175,345	175,345	175,345	175,345	175,345	175,345	175,345	175,345	175,345
Capacity	1,162	1,162	1,162	1,162	1,162	1,162	1,162	1,162	1,162	1,162
Enrollment	1,339	1,406	1,426	1,354	1,413	1,368	1,401	1,352	1,334	1,287
Mabry (1978)										
Square Feet	160,581	160,581	160,581	160,581	165,479	165,479	165,479	165,479	165,479	165,479
Capacity	1,162	1,162	1,162	1,162	1,162	1,162	1,162	1,162	1,162	1,162
Enrollment	847	893	893	889	881	930	938	956	919	881
McCleskey (1983)										
Square Feet	149,577	149,577	149,577	149,577	149,577	149,577	149,577	149,577	149,577	149,577
Capacity	937	937	937	937	937	937	937	937	937	937
Enrollment	678	715	677	696	676	672	692	696	682	609
McClure (2006)										
Square Feet	191,209	191,209	191,209	191,209	191,209	191,209	191,209	191,209	191,209	191,209
Capacity	1,163	1,163	1,163	1,163	1,162	1,162	1,162	1,162	1,162	1,162
Enrollment	1,092	1,090	1,137	1,198	1,234	1,217	1,111	1,070	1,034	1,010
Palmer (2001)										
Square Feet	175,974	175,974	175,974	175,974	175,974	175,974	175,974	175,974	175,974	175,974
Capacity	1,162	1,162	1,162	1,162	1,162	1,162	1,162	1,162	1,162	1,162
Enrollment	963	990	1,024	1,019	942	923	888	905	862	835
Pearson (2021)										
Square Feet	-	-	-	-	-	-	-	-	-	176,646
Capacity	-	-	-	-	-	-	-	-	-	1,012
Enrollment	-	-	-	-	-	-	-	-	-	853
Pine Mountain (1979)										
Square Feet	169,809	169,809	169,809	169,809	169,809	169,809	169,809	169,809	169,809	169,809
Capacity	912	912	912	912	912	912	912	900	900	900
Enrollment	706	710	691	616	597	625	696	694	670	610

continued-

**COBB COUNTY SCHOOL DISTRICT
SCHOOL BUILDINGS
LAST TEN FISCAL YEARS**

<u>School Name</u>	<u>2013</u>	<u>2014</u>	<u>2015</u>	<u>2016</u>	<u>2017</u>	<u>2018</u>	<u>2019</u>	<u>2020</u>	<u>2021</u>	<u>2022</u>
Simpson (1988)										
Square Feet	138,902	143,888	143,888	143,888	143,888	143,888	143,888	143,888	143,888	143,888
Capacity	962	962	962	962	962	962	962	962	962	962
Enrollment	876	895	913	935	960	944	912	898	905	870
Smitha (1993)										
Square Feet	169,345	169,345	169,345	169,345	169,345	169,345	169,345	169,345	169,345	169,345
Capacity	1,137	1,137	1,137	1,137	1,137	1,137	1,137	1,137	1,137	1,137
Enrollment	995	1,001	988	969	991	1,012	1,036	1,050	980	928
Tapp (1975)										
Square Feet	157,435	157,435	157,435	157,435	157,435	157,435	157,435	157,435	157,435	157,435
Capacity	1,137	1,137	1,137	1,137	1,137	1,137	1,137	1,137	1,137	1,137
Enrollment	761	805	769	808	859	939	953	924	913	871
Allatoona (2008)										
Square Feet	325,200	325,200	325,200	330,289	330,289	330,289	330,289	330,289	330,289	330,289
Capacity	1,912	1,912	1,912	1,912	1,912	1,912	1,912	1,937	1,937	1,937
Enrollment	1,717	1,724	1,773	1,717	1,670	1,704	1,692	1,784	1,780	1,701
Campbell (1963)										
Square Feet	374,180	374,180	374,180	374,180	374,180	374,180	427,488	376,451	370,227	497,352
Capacity	2,637	2,637	2,637	2,637	2,638	2,638	2,662	2,562	2,562	3,303
Enrollment	2,188	2,258	2,380	2,509	2,600	2,731	2,743	2,820	2,816	2,698
Cobb Horizon (1944)(Oakwood)(e)										
Square Feet	93,858	93,858	93,858	93,858	93,858	93,858	93,858	93,858	-	-
Capacity	462	462	462	462	462	462	462	462	-	-
Enrollment	70	78	91	63	55	68	227	334	-	-
Cobb Horizon(2021)										
Square Feet	-	-	-	-	-	-	-	-	94,627	94,627
Capacity	-	-	-	-	-	-	-	-	362	337
Enrollment	-	-	-	-	-	-	-	-	336	252
Harrison (1991)										
Square Feet	243,215	337,584	337,584	337,584	337,584	337,584	333,954	444,830	444,830	444,830
Capacity	1,837	2,587	2,587	2,587	2,587	2,587	2,538	2,587	2,587	2,587
Enrollment	1,918	1,927	1,926	1,949	2,024	2,165	2,315	2,314	2,211	2,200
Hillgrove (2006)										
Square Feet	319,000	319,000	319,000	319,000	319,000	319,000	319,000	319,000	319,000	319,000
Capacity	1,987	1,987	1,987	1,987	1,987	1,962	1,962	1,987	1,987	1,937
Enrollment	2,065	2,115	2,213	2,334	2,371	2,395	2,343	2,317	2,233	2,293
Kell (2002)										
Square Feet	321,068	321,068	321,068	321,068	321,068	321,068	321,068	321,068	321,068	321,068
Capacity	1,987	1,987	1,987	1,987	1,987	2,013	2,013	2,025	2,025	2,025
Enrollment	1,526	1,509	1,499	1,437	1,484	1,451	1,451	1,451	1,406	1,399
Kennesaw Mountain (2000)										
Square Feet	319,000	319,000	319,000	319,000	319,000	319,000	319,000	319,000	319,000	319,000
Capacity	1,987	1,987	1,987	1,987	1,987	1,987	1,987	1,987	1,987	1,987
Enrollment	2,121	2,080	2,090	2,120	2,099	2,001	1,878	1,824	1,754	1,799
Lassiter (1981)										
Square Feet	310,950	310,950	310,950	310,950	310,950	310,950	300,195	376,835	376,835	376,835
Capacity	2,112	2,112	2,112	2,112	2,112	2,112	2,062	2,087	2,087	2,087
Enrollment	1,944	2,010	2,086	2,121	2,179	2,145	2,087	2,051	1,959	1,920
McEachern (1930)										
Square Feet	504,107	504,107	504,107	504,107	504,107	504,107	504,107	504,107	504,107	504,107
Capacity	2,362	2,362	2,362	2,362	2,362	2,362	2,362	2,450	2,450	2,450
Enrollment	2,174	2,168	2,137	2,199	2,227	2,289	2,312	2,345	2,302	2,240
North Cobb (1957)										
Square Feet	406,817	406,817	406,817	406,817	406,817	406,817	485,833	485,833	485,833	485,833
Capacity	2,787	2,787	2,787	2,787	2,787	2,787	2,838	2,862	2,862	2,862
Enrollment	2,533	2,651	2,750	2,755	2,810	2,762	2,730	2,769	2,634	2,514
Osborne (1961)										
Square Feet	328,000	328,000	328,000	328,000	328,000	328,000	220,696	220,696	469,966	466,189
Capacity	2,062	2,062	2,062	2,062	2,062	2,062	2,062	2,062	2,062	2,312
Enrollment	1,701	1,798	1,812	1,821	1,977	1,973	2,004	2,102	2,222	2,443
Pebblebrook (1963)										
Square Feet	319,768	319,768	319,768	319,768	319,768	319,768	319,768	264,915	264,915	264,915
Capacity	1,788	1,788	1,788	1,788	1,788	1,788	1,788	1,537	1,537	1,537
Enrollment	1,990	2,029	2,173	2,377	2,375	2,438	2,353	2,313	2,216	2,279

**COBB COUNTY SCHOOL DISTRICT
SCHOOL BUILDINGS
LAST TEN FISCAL YEARS**

<u>School Name</u>	<u>2013</u>	<u>2014</u>	<u>2015</u>	<u>2016</u>	<u>2017</u>	<u>2018</u>	<u>2019</u>	<u>2020</u>	<u>2021</u>	<u>2022</u>
Pope (1987)										
Square Feet	260,606	260,606	260,606	260,606	260,606	336,955	336,955	336,955	336,955	336,955
Capacity	1,912	1,912	1,912	1,912	1,912	1,912	1,912	1,912	1,912	1,912
Enrollment	1,725	1,787	1,868	1,919	1,990	1,957	1,915	1,921	1,830	1,803
South Cobb (1951)										
Square Feet	388,425	388,425	388,425	388,425	388,425	388,425	420,443	420,443	420,443	420,443
Capacity	2,612	2,612	2,612	2,612	2,612	2,612	2,638	2,612	2,612	2,612
Enrollment	1,898	1,911	1,954	1,906	1,899	1,796	1,891	1,919	1,903	1,876
Sprayberry (1973)										
Square Feet	297,400	297,400	297,400	297,400	297,400	297,400	297,400	297,400	297,400	297,400
Capacity	2,062	2,062	2,062	2,062	2,062	2,062	2,062	2,087	2,087	2,087
Enrollment	1,741	1,700	1,701	1,703	1,610	1,643	1,698	1,728	1,766	1,814
Walton (1975)										
Square Feet	307,655	307,655	307,655	307,655	307,655	373,256	342,656	466,505	466,505	466,505
Capacity	2,312	2,312	2,312	2,312	2,312	2,312	2,312	2,837	2,837	2,837
Enrollment	2,574	2,639	2,582	2,616	2,615	2,603	2,643	2,614	2,674	2,651
Wheeler (1964)										
Square Feet	318,504	361,490	341,594	440,214	434,631	434,631	434,631	434,631	434,631	434,631
Capacity	1,837	2,162	2,112	2,187	2,187	2,187	2,187	2,187	2,187	2,187
Enrollment	1,948	2,049	2,008	2,075	2,076	2,063	2,125	2,153	2,220	2,249
Performance Learning Center (located at Oakwood)(e)										
Enrollment	59	70	93	148	147	122	-	-	-	-
Hawthorne (Haven) (1958) (c)										
Square Feet	32,500	32,500	32,500	-	-	-	-	-	-	-
Capacity	312	312	312	-	-	-	-	-	-	-
Enrollment	77	69	77	-	-	-	-	-	-	-
Fitzhugh Lee (Haven) (1935)(c)										
Square Feet	35,684	35,684	35,684	-	-	-	-	-	-	-
Capacity	312	312	312	-	-	-	-	-	-	-
Enrollment	39	33	37	-	-	-	-	-	-	-
Kennesaw Charter (d)										
Enrollment	782	871	858	838	778	558	464	287	-	-
Mableton Charter (d)										
Enrollment	-	-	-	-	-	-	-	-	-	-
International Academy of Smyrna (d)										
Enrollment	943	944	966	1,033	993	-	-	-	-	-
Devereux Georgia (d)										
Enrollment	75	87	88	78	86	89	79	66	46	50
Sky View (1957) (b) (Haven - 2016)										
Square Feet	-	-	-	50,270	50,270	50,270	50,270	50,270	50,270	50,270
Capacity	-	-	-	462	462	462	462	462	462	462
Enrollment	-	-	-	119	102	86	66	75	64	65
South Cobb Early Learning										
Square Feet	-	-	-	-	-	-	-	-	65,127	65,127
Capacity	-	-	-	-	-	-	-	-	512	512
Enrollment	-	-	-	-	-	-	-	-	334	393

Concluded.

(a) Original Clarkdale building destroyed by flood fall 2009. Clarkdale Replacement school opened for school year 2012-13.

(b) In fiscal year 2016, Haven Academy combined its two campuses (Fitzhugh Lee and Hawthorne) to become a one campus program at the Sky View facility.

(c) Haven @ Fitzhugh Lee enrollment is included with Hawthorne until school year 2010-11.

(d) Operated by a nonprofit, enrollment reported by CCSD; buildings do not belong to CCSD. Mableton Charter closed May 2012.

(e) Oakwood and the Performance Learning Center opened as Cobb Horizon High School on the Oakwood campus August 2018.

(f) City View originally Riverside Intermediate. Name changed in 2021.

Data reflects the new Five-Year Local Facilities Plan approved by the Board on April 28, 2016. The 2016 - 2020 Local Facilities Plan has been approved by the Georgia Department of Education and validated by a Facilities Survey Team as required by State BOE rules.

Source: District Records

**COBB COUNTY SCHOOL DISTRICT
TEACHERS' SALARY SCHEDULE
LAST TEN FISCAL YEARS**

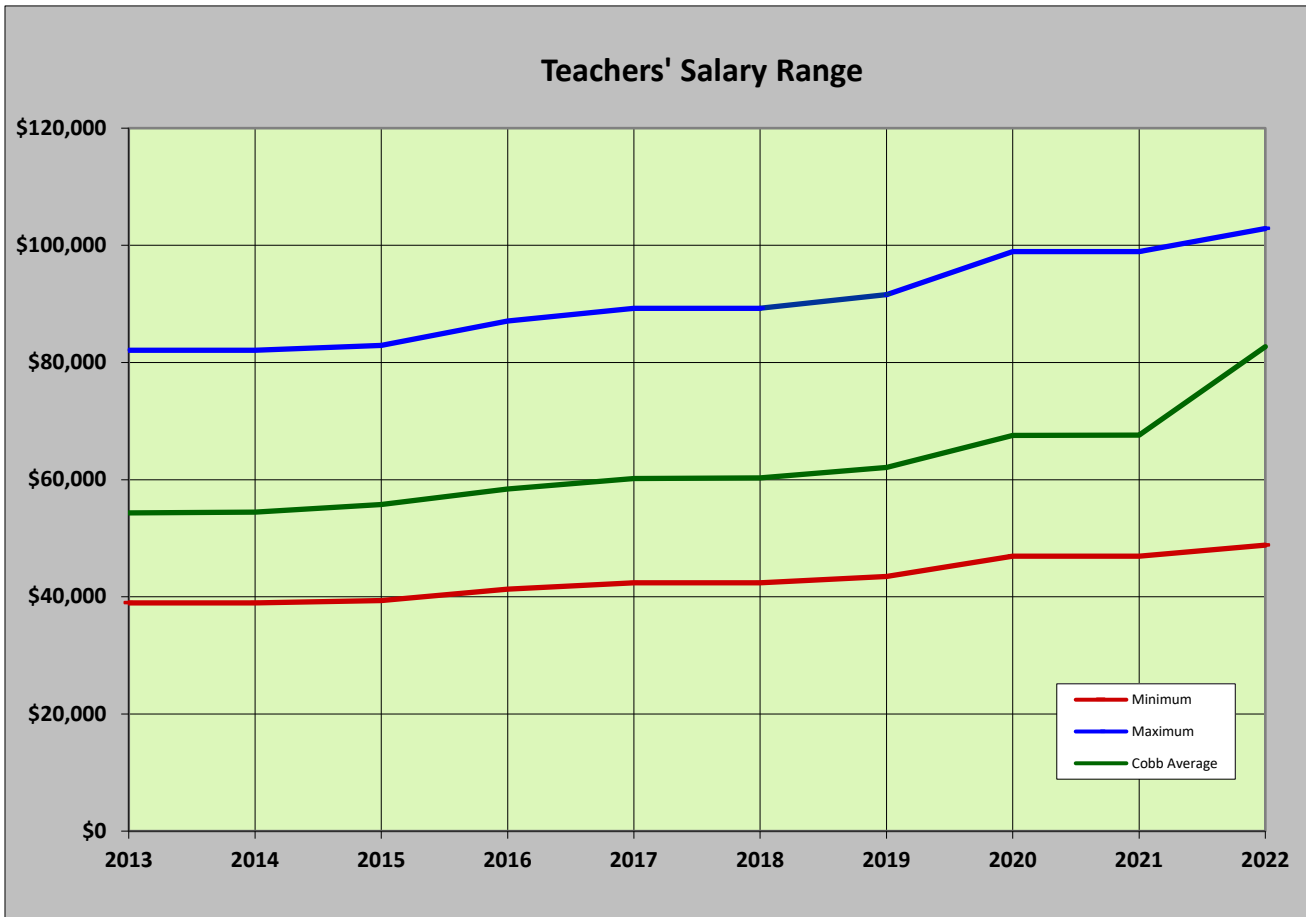

Fiscal Year	Minimum	Maximum	Cobb Average	State-wide Average
2013	\$ 38,958	\$ 82,088	\$ 54,323	\$ 52,956
2014	38,958	82,088	54,435	52,973
2015	39,347	82,908	55,773	53,424
2016	41,330	87,087	58,425	54,215
2017	42,364	89,264	60,185	55,530
2018	42,364	89,264	60,309	56,333
2019	43,465	91,585	62,066	57,066
2020	46,942	98,912	67,545	60,552
2021	46,942	98,912	67,618	60,543
2022	48,820	102,868	82,698	62,185

Note: Minimum reflects T-4 Certification, Step 1; Maximum is T-7 Doctorate, Step 30+.

Source: District Salary Schedules, Georgia Department of Education

**COBB COUNTY SCHOOL DISTRICT
 ADMINISTRATIVE SALARY SCHEDULE
 JUNE 30, 2022**

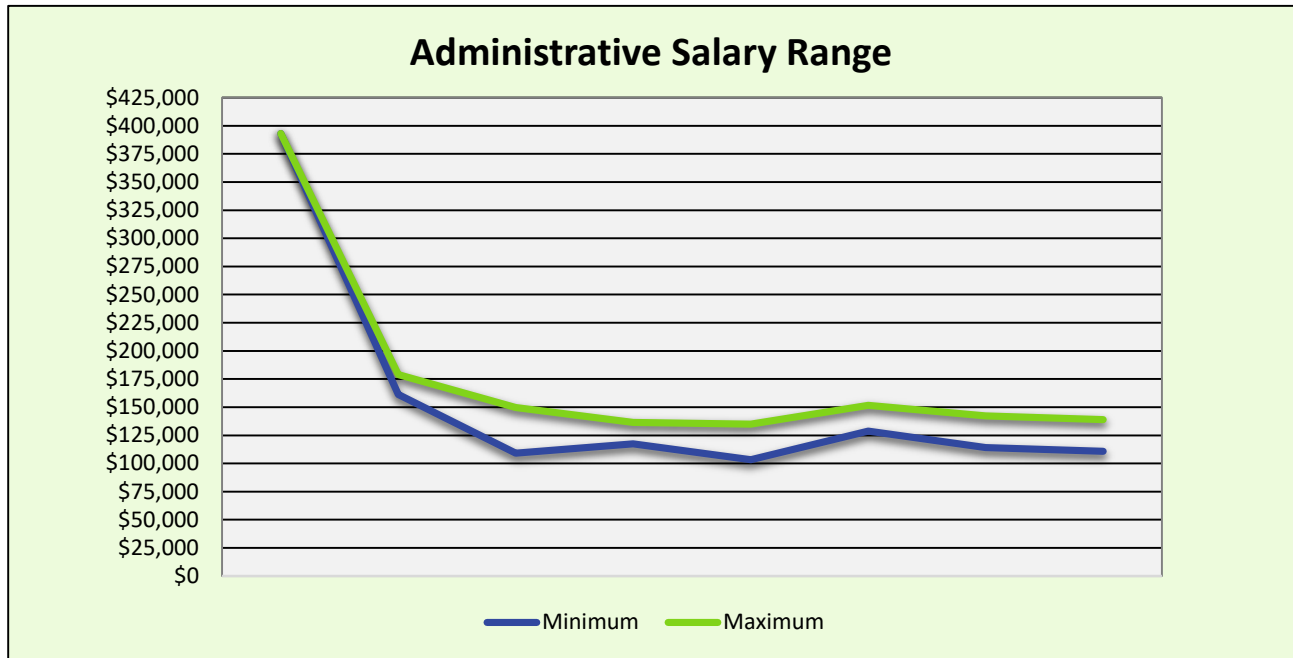

<u>Administrative Position Title</u>	<u>Minimum</u>	<u>Maximum</u>
Superintendent	\$ 393,120	\$ 393,120
Chief Officers/Asst Superintendents	161,289	178,863
Executive Directors	109,274	149,812
Instructional Directors	117,452	136,453
Classified Directors	103,334	134,947
High School Principals	128,766	151,605
Middle School Principals	114,232	142,256
Elementary School Principals	110,808	138,829

Source: District Records

**COBB COUNTY SCHOOL DISTRICT
SCHEDULE OF INSURANCE IN FORCE
JUNE 30, 2022**

<u>Type of Coverage</u>	<u>Name of Company and Policy Number</u>	<u>Policy Period</u>		<u>Liability Limits</u>	<u>Annual Premium</u>
		<u>From</u>	<u>To</u>		
Automobile Physical Damage	Hudson Insurance PEA000527801	07/1/2021	07/1/2022		\$75,193
Bus, Truck, Motor Vehicles Liability	Self Insured	6/1/1994	Ongoing	\$300,000	N/A
Property Theft	Self Insured	6/1/1994	Ongoing	N/A	N/A
Employee's Blanket Bond	Berkley Crime BGOV4500236625	8/1/2021	8/1/2022	\$7,500,000	\$24,722
General Liability	Self Insured	6/1/1994	Ongoing	\$500,000	N/A
Property Boiler (Includes Insurance)	Travelers KTJ-CMB-1G46706-9-21	7/1/2021	7/1/2022	\$500,000,000	\$923,588
Student Athletic	T.W. Lord & Associates	8/1/2021	8/1/2022	Varies	Student/Parent Funded
Student Liability (Nursing Program)	Liberty Insurance AHV103741003	2/1/2022	2/01/2023	\$1,000,000	\$1,565
Superintendent's Bond	Old Republic Surety Co. APO2121620	5/1/2022	5/1/2023	\$100,000	\$350
Principal's Bond	Old Republic Surety Co. APS1177822	8/1/2021	8/1/2022	\$10,000	\$3,990
Worker's Compensation	Self Insured	N/A	N/A	Statutory	N/A
Excess Worker's Compensation	Star Insurance WCE-0937879	10/1/2021	10/1/2022	\$1,000,000	\$234,142
Parking Lot GL Policy	Atain Speciality BWPF0070271	11/30/2021	11/30/2022	\$2,000,000	\$1,901
Excess Flood Garrett Middle School	Lloyd's of London DEF11670005306	07/01/2021	07/01/2022	\$15,453,434	\$15,453
Drone Insurance	Old Republic Surety Co. AVC00410305	01/18/2022	1/18/2023	\$1,000,000	\$1,400
Disability, Long-Term	The Hartford 402273	1/1/2022	12/31/2022	Benefit Schedule per salary	\$1,122,379
Disability, Short-Term	The Hartford 402273	1/1/2022	12/31/2022		Salary Based
STD Plan Option 1				14 Day Elimination Period. 66.67% of standard income up to \$1,500 per week.	Employee pays \$.230 per \$10 of weekly benefit.
STD Plan Option 2				60 Day Elimination Period. 66.67% of standard weekly income, up to \$1,500 per week.	Employee pays \$.132 per \$10 of weekly benefit.
STD Plan Option 3				14 Day Elimination Period. 50% of standard weekly income, up to \$1,200 per week.	Employee pays \$.231 per \$10 of weekly benefit.
STD Plan Option 4				60 Day Elimination Period. 50% of standard weekly income, up to \$1,200 per week.	Employee pays \$.145 per \$10 of weekly benefit.
Life Insurance and AD&D	The Hartford 402273	1/1/2022	12/31/2022		The first \$15,000 is paid by CCSD. (smokers and non-smokers) Employee can add \$.135 per \$1000.00

**COBB COUNTY SCHOOL DISTRICT
SCHEDULE OF INSURANCE IN FORCE
JUNE 30, 2022**

<u>Type of Coverage</u>	<u>Name of Company and Policy Number</u>	<u>Policy Period</u>		<u>Liability Limits</u>	<u>Annual Premium</u>
		<u>From</u>	<u>To</u>		
Dependent Life	The Hartford 402273	1/1/2022	12/31/2022	Coverage options: Child \$10,000 or \$25,000 Spouse up to \$50,000	Employee pays \$1.74 for \$10,000 of coverage of child(ren) or \$4.36 for \$25,000 of coverage; Spousal coverage rate depends on the age of the spouse.
Optional Life and AD&D	The Hartford 402273	1/1/2022	12/31/2022	Employee can choose up to 7 times his/her annual earnings. (Max. \$500,000)	Employee pays \$0.152 per \$1,000 of Supplemental Life coverage monthly.
Dental Insurance Plus Option	MetLife Dental 158287	1/1/2022	12/31/2022	Plus Plan provides preferred rates with a maximum coverage of \$1,000 per participant per calendar	Employee pays \$40.56 for single coverage, \$75.86 for employee plus one, or \$123.72 for family coverage monthly.
Base Option		1/1/2022	12/31/2022	Base Plan has co-pays for Preventative and Diagnostic services with a maximum of \$750 coverage per participant per calendar year.	Employee pays \$17.00 for single coverage, \$32.00 for employee plus one, or \$55.00 for family coverage monthly.
Critical Illness with Cancer Insurance	Voya 70174-2	1/1/2022	12/31/2022	Based on Benefit Schedule	Cost is determined based on age and amount of coverage elected by employee.
Vision Insurance Plus Plan	MetLife Vision 158288	1/1/2022	12/31/2022	Based on Benefit Schedule	Employee pays rates monthly <u>depending on chosen plan.</u> Single coverage is \$8.30; coverage for employee plus one family member is \$15.48, and family coverage is \$23.00 each month.
Base Plan		1/1/2022	12/31/2022		Single coverage is \$6.86; coverage for employee plus one family member is \$12.82, and family coverage is \$19.06 each month.
Legal Insurance	ARAG Group 17840	1/1/2022	12/31/2022	Based on Benefit Schedule	Employee pays \$13.52 for single coverage or \$16.88 for family Coverage monthly.
Accident Insurance	Voya 70174-2	1/1/2022	12/31/2022	Based on Benefit Schedule	Employee pays monthly premium of \$7.58 self, \$12.58 self and spouse, \$14.84 self and children, or \$19.84 family.
Hospital Indemnity	Voya 70174-2	1/1/2022	12/31/2022	Based on Benefit Schedule	Employee pays monthly premium of \$9.54 self, \$22.62 self and spouse, \$14.60 self and children, or \$27.70 family.

Concluded.

Source: District Records

**COBB COUNTY SCHOOL DISTRICT
SCHOOL LUNCH AND BREAKFAST PROGRAM
LAST TEN FISCAL YEARS**

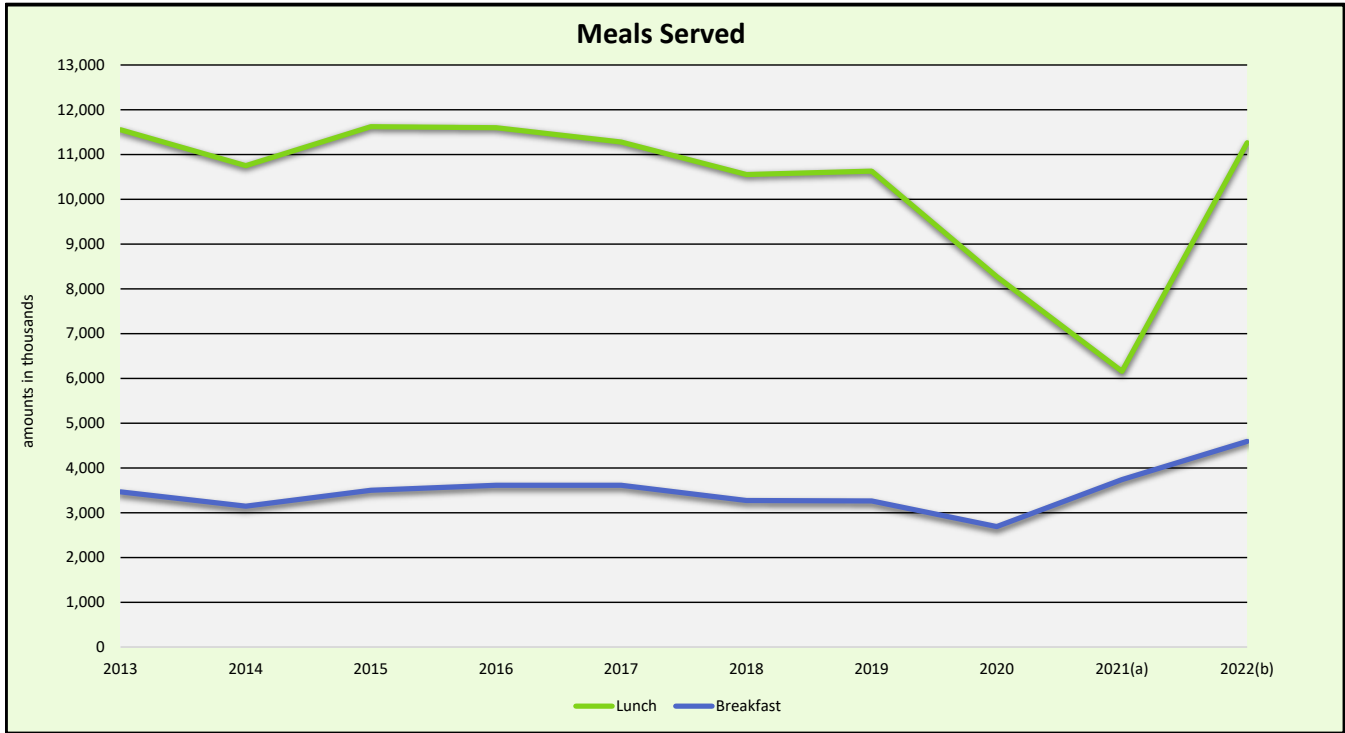

(amounts expressed in thousands)

	2013	2014	2015	2016	2017	2018	2019	2020	2021(a)	2022(b)
Lunch Meals Served:										
Free	6,259	5,974	6,317	6,360	6,119	5,569	5,430	4,153	6,129	11,260
Reduced	805	748	813	783	868	834	860	695	13	0
Paid	4,489	4,031	4,492	4,455	4,293	4,149	4,339	3,423	16	6
Total	11,553	10,753	11,622	11,598	11,280	10,552	10,629	8,271	6,158	11,266
Daily Average	65	64	66	64	63	61	60	62	36	64
Student Price	\$2.15-\$2.40	\$2.15-\$2.40	\$2.15-\$2.40	\$2.25-\$2.50	\$2.25-\$2.50	\$2.25-\$2.50	\$2.35-\$2.60	\$2.35-\$2.60	\$2.50-\$2.75	\$2.75-\$3.00
Breakfast Meals Served:										
Free	2,827	2,586	2,850	2,916	2,853	2,527	2,456	1,988	3,713	4,590
Reduced	231	206	239	246	290	275	288	242	13	0
Paid	407	354	414	453	468	469	517	460	16	3
Total	3,465	3,146	3,503	3,615	3,611	3,271	3,261	2,690	3,742	4,593
Daily Average	20	19	20	20	20	19	18	20	22	26
Student Price	\$1.25	\$1.25	\$1.25	\$1.25	\$1.25	\$1.25	\$1.25	\$1.50	\$1.75	\$1.75
Total Meals Served:										
Free	9,086	8,560	9,167	9,276	8,972	8,096	7,886	6,141	9,841	15,850
Reduced	1,036	954	1,052	1,029	1,158	1,159	1,109	937	26	0
Paid	4,896	4,385	4,906	4,908	4,761	4,762	4,618	3,883	32	9
Total	15,018	13,899	15,125	15,213	14,891	13,823	13,890	10,961	9,900	15,859
Daily Average	85	83	86	84	83	80	78	82	58	90

Free & Reduced Meals Percentage of Total	67%	68%	68%	68%	68%	67%	65%	65%	n/a	n/a
--	-----	-----	-----	-----	-----	-----	-----	-----	-----	-----

(a) Due to the pandemic, USDA made all student meals free for the majority of the 2021 school year.

(b) Due to the pandemic, USDA made all student meals free for the 2022 school year and the majority of the summer learning recovery program.

Source: District Records

**COBB COUNTY SCHOOL DISTRICT
NUMBER OF SCHOOLS
LAST TEN FISCAL YEARS**

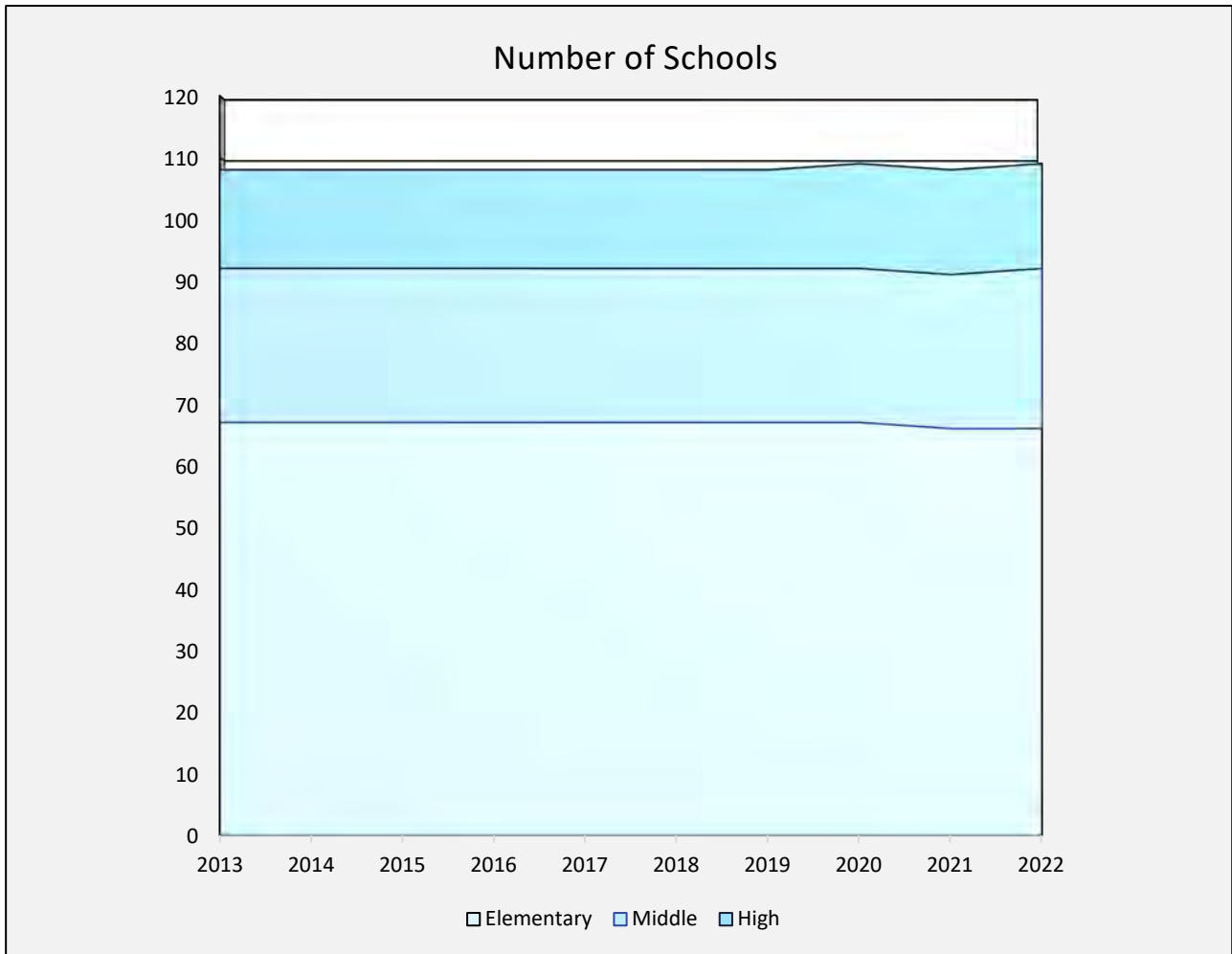

<u>Fiscal Year</u>	<u>Elementary</u>	<u>Middle</u>	<u>High</u>	<u>Total</u>
2013	67	25	16	108
2014	67	25	16	108
2015	67	25	16	108
2016	67	25	16	108
2017	67	25	16	108
2018	67	25	16	108
2019	67	25	16	108
2020	67	25	17	109
2021	66	25	17	108
2022	66	26	17	109

- Elementary, Middle and High Schools only. Special schools not listed.
- Oakwood High School converted to digital academy in 2012 becoming a Special school.
- Sky View Elementary converted to Administrative Facility in 2013.
- In 2014, Brown Elementary closed and Smyrna Elementary opened for instruction.
- In 2022, Pearson Middle School opened for instruction.

**COBB COUNTY SCHOOL DISTRICT
NUMBER OF HIGH SCHOOL GRADUATES AND
AVERAGE DAILY ENROLLMENT AND ATTENDANCE
LAST TEN FISCAL YEARS**

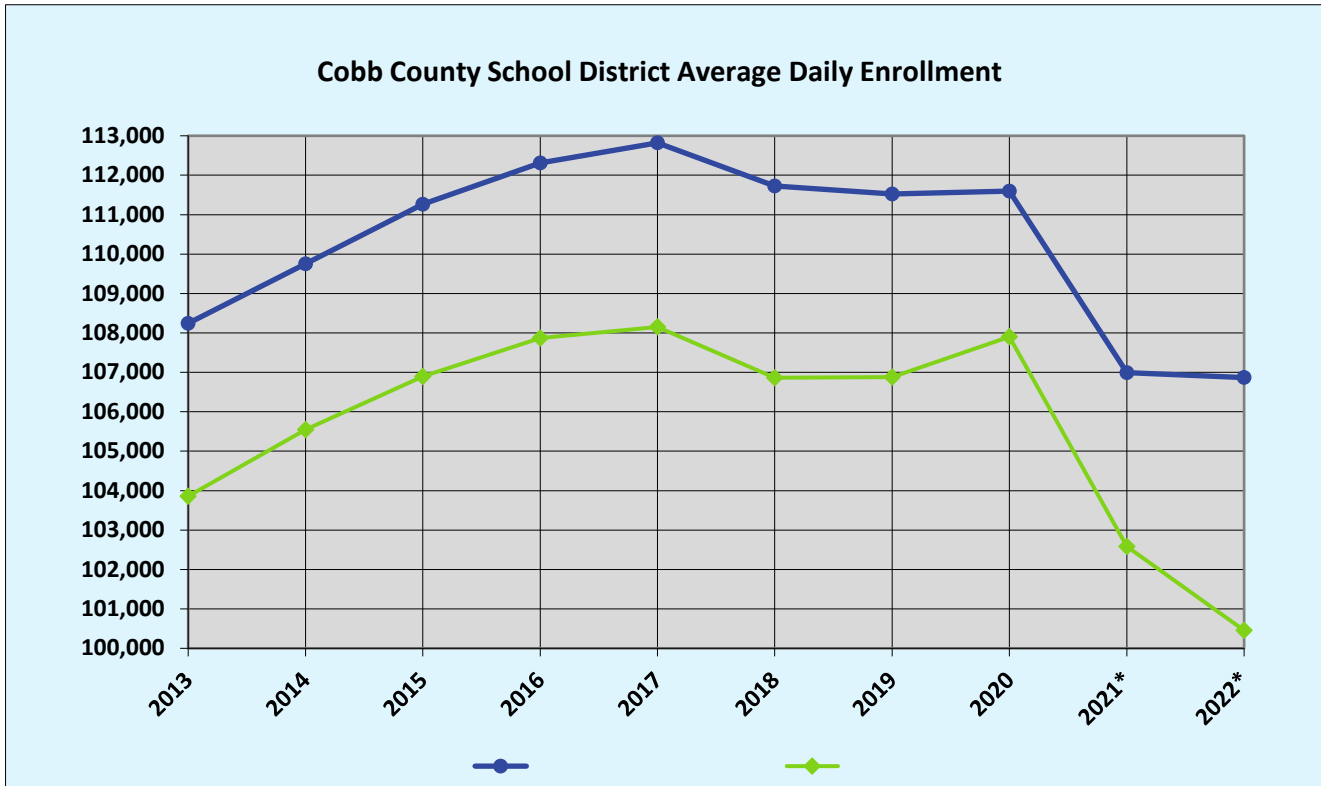

<u>Fiscal Year</u>	<u>Average Daily Enrollment</u>	<u>Average Daily Attendance</u>	<u>Attendance Percentage</u>	<u>Number of Graduates</u>	<u>Graduate Percentage</u>
2013	108,240	103,857	96%	7,425	76.50%
2014	109,752	105,548	96%	7,313	78.20%
2015	111,264	106,895	96%	7,366	81.45%
2016	112,308	107,872	96%	7,714	83.80%
2017	112,821	108,150	96%	7,970	83.60%
2018	111,723	106,863	96%	8,126	85.20%
2019	111,527	106,876	96%	8,261	87.00%
2020	111,593	107,899	97%	8,379	88.60%
2021*	106,994	102,586	96%	8,084	87.20%
2022*	106,867	100,455	94%	8,278	87.40%

Note: Beginning in 2016 Graduate Percentages were adjusted to match the Georgia Department of Education four-year Adjusted Cohort Graduation Rate (ACGR). This rate calculation began for the school year ended 2012 and is released in October with a one-year lag. (i.e. the school year ended 2016 will be available October 2017)

*Average daily enrollment affected by pandemic.

**COBB COUNTY SCHOOL DISTRICT
ACTIVE ENROLLMENT BY GRADE LEVEL
LAST TEN FISCAL YEARS**

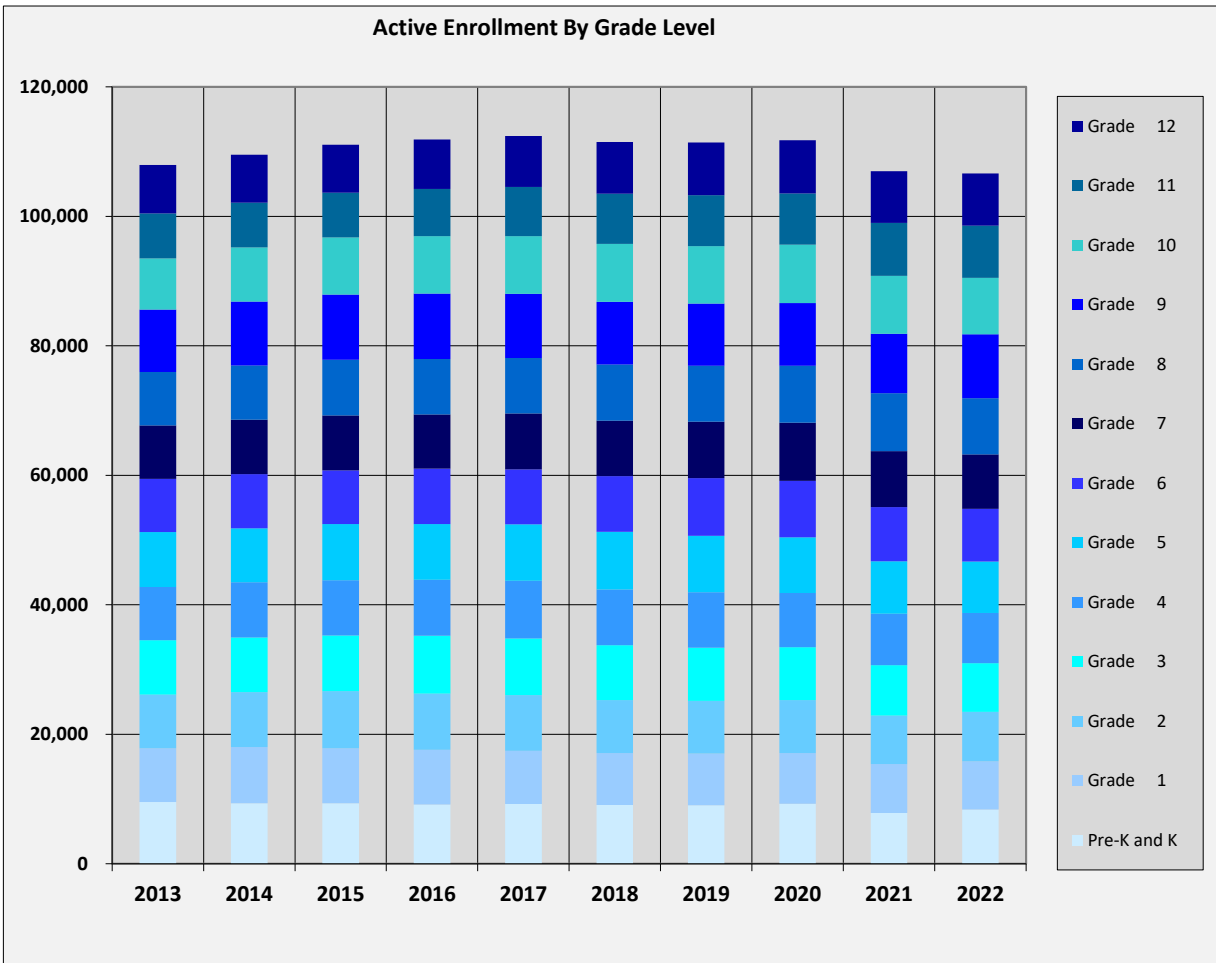

Year	Pre-K and K	Grade 1	Grade 2	Grade 3	Grade 4	Grade 5	Grade 6	Grade 7	Grade 8	Grade 9	Grade 10	Grade 11	Grade 12
2013	9,523	8,297	8,296	8,422	8,191	8,495	8,242	8,249	8,229	9,637	7,938	6,931	7,464
2014	9,363	8,669	8,473	8,464	8,503	8,331	8,389	8,381	8,372	9,874	8,394	6,882	7,434
2015	9,363	8,461	8,829	8,592	8,541	8,680	8,290	8,474	8,599	10,090	8,817	6,918	7,406
2016	9,164	8,453	8,643	8,978	8,610	8,610	8,562	8,385	8,574	10,077	8,890	7,280	7,622
2017	9,224	8,230	8,606	8,729	8,914	8,742	8,461	8,640	8,564	9,902	8,943	7,594	7,863
2018	9,087	8,028	8,171	8,458	8,614	8,919	8,597	8,550	8,675	9,698	8,933	7,753	7,999
2019	9,024	7,995	8,154	8,216	8,556	8,700	8,916	8,727	8,616	9,623	8,853	7,873	8,133
2020	9,256	7,838	8,186	8,178	8,347	8,613	8,740	8,949	8,816	9,684	9,001	7,945	8,207
2021	7,830	7,587	7,478	7,768	7,944	8,110	8,380	8,631	8,943	9,180	8,961	8,162	8,009
2022	8,387	7,427	7,629	7,529	7,758	7,956	8,122	8,435	8,674	9,872	8,722	8,061	8,029

Source: District Records

COBB COUNTY SCHOOL DISTRICT
 CLASSROOM BUILDINGS, GRADE LEVELS AND ACREAGE
 JUNE 30, 2022

<u>School Name</u>	<u>Grades</u>	<u>Active Enrollment</u>	<u>Size of Site (acres)</u>	<u>Occupied Year (a)</u>	<u>Number of Classrooms</u>	<u>Portable Classrooms</u>	<u>Square Footage</u>	<u>Capacity</u>
Acworth Elementary	2-5	550	15.0	2001	59	-	131,924	925
Addison	K-5	622	12.5	1989	42	-	81,334	662
Argyle	K-5	302	8.8	1961	36	2	56,904	562
Austell	K-5	406	12.4	2005	36	-	85,236	562
Baker	K-5	784	15.0	1988	65	-	106,694	1,025
Bells Ferry	K-5	730	10.0	1962	46	6	83,098	737
Belmont Hills	K-5	309	10.2	1952	36	-	68,409	562
Big Shanty	3-5	515	22.3	1969	52	2	84,461	837
Birney	K-5	662	26.8	1973	59	1	105,886	925
Blackwell	K-5	627	16.0	1997	52	-	111,299	837
Brown (b)	K-5	-	6.2	1955	24	-	49,828	412
Brumby	K-5	948	18.0	2018	73	-	168,576	1,162
Bryant	K-5	854	22.9	1991	61	4	116,071	962
Bullard	K-5	780	20.0	2003	63	-	136,261	987
Chalker	K-5	659	25.5	1997	62	-	124,148	975
Cheatham Hill	K-5	1,022	19.2	1997	68	3	137,108	1,063
City View	K-5	848	25.0	2001	61	-	123,000	962
Clarkdale	K-5	688	15.0	2012	55	-	129,988	887
Clay- Harmony Leland	K-5	926	15.2	2020	78	-	186,930	1,250
Clay	K-5	-	8.0	1961	29	-	55,412	450
Compton	K-5	564	28.3	1969	50	-	88,079	800
Davis	K-5	614	13.0	1987	50	-	86,131	800
Dowell	K-5	860	28.9	1989	62	-	106,003	975
Due West	K-5	603	10.2	1957	38	-	70,367	600
East Side	K-5	1,157	11.0	2011	69	-	149,764	1,087
Eastvalley	K-5	687	9.6	1960	36	16	60,029	562
Fair Oaks	K-5	770	10.3	1957	54	-	97,993	875
Ford	K-5	781	39.0	1991	53	2	91,129	862
Frey	K-5	757	26.2	1996	62	-	125,717	975
Garrison Mill	K-5	674	14.1	1984	44	-	85,775	700
Green Acres	K-5	592	10.1	1995	44	-	90,915	700
Hayes	K-5	828	24.2	1994	61	2	119,189	962
Hendricks	K-5	483	23.0	2002	61	-	123,025	962
Hollydale	K-5	556	15.0	1968	53	-	89,012	862
Keheley	K-5	414	20.7	1987	38	-	70,537	600
Kemp	K-5	898	28.0	2003	61	-	123,000	962
Kennesaw	K-2	584	20.7	1992	62	-	116,400	975
Kincaid	K-5	577	24.0	1972	48	-	83,969	762
King Springs	K-5	1,034	9.9	2020	69	-	154,696	1,050
LaBelle	K-5	357	10.2	1955	44	-	82,912	700
Lewis	K-5	535	10.9	1986	61	-	115,363	962
Mableton	K-5	915	12.1	2012	61	-	148,523	962
McCall Primary	K-1	272	6.0	2005	36	-	88,158	512
Milford	K-5	351	8.7	1954	40	-	73,352	637
Mount Bethel	K-5	996	25.0	1978	60	4	110,096	937
Mountain View	K-5	772	16.1	2017	61	-	144,362	962
Murdock	K-5	955	15.3	1975	61	1	123,233	962
Nicholson	K-5	413	23.1	1989	40	-	75,800	637
Nickajack	K-5	1,116	16.8	1998	60	7	122,342	937
Norton Park	K-5	701	9.2	1961	52	7	87,935	837
Pickett's Mill	K-5	689	40.9	2008	63	-	139,090	987
Pitner	K-5	767	22.2	2003	61	-	136,261	962
Powder Springs	K-5	789	15.9	1988	57	-	101,870	900
Powers Ferry	K-5	402	10.0	1951	30	4	59,190	462
Riverside Elementary	K-5	521	9.0	2005	36	-	85,236	562
Rocky Mount	K-5	569	21.8	1977	39	-	72,896	612
Russell	K-5	552	14.1	1961	61	1	104,362	962
Sanders	K-5	633	21.1	1997	53	-	116,302	862

COBB COUNTY SCHOOL DISTRICT
 CLASSROOM BUILDINGS, GRADE LEVELS AND ACREAGE
 JUNE 30, 2022

School Name	Grades	Active	Size of	Occupied	Number of	Portable	Square	Capacity
		Enrollment	Site (acres)	Year (a)	Classrooms	Classrooms	Footage	
Sedalia Park	K-5	619	10.2	1956	58	2	99,735	912
Shallowford Falls	K-5	615	15.3	1990	61	-	112,620	962
Smyrna	K-5	914	11.9	2013	61	3	143,107	962
Sope Creek	K-5	1,061	16.0	1978	73	-	133,344	1,162
Still	K-5	747	10.9	1978	62	-	117,539	975
Teasley	K-5	935	12.9	1961	52	6	108,100	837
Timber Ridge	K-5	489	11.5	1990	39	-	73,450	612
Tritt	K-5	817	23.7	1979	60	-	109,769	937
Varner	K-5	746	20.0	1991	62	-	109,827	975
Vaughan	K-5	647	28.0	1996	60	-	122,260	937
Awtrey	6-8	649	26.2	1964	64	-	156,660	1,037
Barber	6-8	864	25.8	2005	71	-	178,465	1,162
Campbell	6-8	1,191	33.2	1951	87	-	220,228	1,437
Cooper	6-8	1,055	75.1	2001	71	-	170,905	1,162
Daniell	6-8	930	20.0	1965	72	-	177,356	1,175
Dickerson	6-8	1,200	21.9	1980	73	-	166,048	1,187
Dodgen	6-8	1,210	20.6	1975	73	-	183,798	1,187
Durham	6-8	999	43.0	1998	71	-	173,487	1,162
East Cobb	6-8	1,323	17.6	2018	84	-	222,963	1,387
Floyd	6-8	881	20.0	1964	68	-	166,551	1,112
Garrett	6-8	936	36.6	1972	60	4	152,212	975
Griffin	6-8	954	24.4	1972	70	3	186,947	1,137
Hightower Trail	6-8	1,025	26.4	1993	62	-	149,038	1,012
Lindley 6th Grade Academy	6	534	28.7	1962	44	-	11,260	700
Lindley	7-8	1,154	33.3	2001	71	-	179,170	1,162
Lost Mountain	6-8	991	83.8	1992	70	-	165,107	1,137
Lovinggood	6-8	1,287	29.4	2006	71	-	175,345	1,162
Mabry	6-8	881	22.0	1979	71	-	165,479	1,162
McCleskey	6-8	609	34.8	1980	58	-	149,577	937
McClure	6-8	1,010	38.0	2006	71	-	191,209	1,162
Palmer	6-8	835	43.1	2001	71	-	175,974	1,162
Pearson	6-8	853	10.0	2021	62	-	176,646	1,012
Pine Mountain	6-8	610	39.7	1979	56	-	169,809	900
Simpson	6-8	870	22.0	1988	59	-	143,888	962
Smitha	6-8	928	25.5	1993	70	-	169,345	1,137
Tapp	6-8	871	16.9	1975	70	-	157,435	1,137
Allatoona	9-12	1,701	114.7	2008	100	-	330,289	1,937
Campbell	9-12	2,698	47.9	1964	169	-	497,352	3,303
Cobb Horizon	9-12	252	16.1	2020	20	-	94,627	337
Harrison	9-12	2,200	73.0	1991	133	-	444,830	2,587
Hillgrove	9-12	2,293	100.9	2006	100	-	319,000	1,937
Kell	9-12	1,399	63.1	2002	104	-	321,068	2,025
Kennesaw Mountain	9-12	1,799	75.0	2001	102	-	319,000	1,987
Lassiter	9-12	1,920	49.3	1980	107	-	376,835	2,087
McEachern	9-12	2,240	74.9	1930	126	-	504,107	2,450
North Cobb	9-12	2,514	46.8	1957	147	-	485,833	2,862
Osborne	9-12	2,443	51.0	1961	124	-	466,189	2,312
Pebblebrook	9-12	2,279	52.5	1963	80	14	264,915	1,537
Pope	9-12	1,803	47.0	1987	98	-	336,955	1,912
South Cobb	9-12	1,876	66.0	1951	134	-	420,443	2,612
Sprayberry	9-12	1,814	41.3	1973	107	-	297,400	2,087
Walton	9-12	2,651	65.2	1975	145	-	466,505	2,837
Wheeler	9-12	2,249	48.4	1964	116	-	434,631	2,187
Hawthorne (Haven)	6-12		6.2	1958	18	-	32,500	312
Skyview (Haven)	K-12	65	10.1	1957	30	-	50,270	462
Devereux Georgia (c)	1-12	50						
South Cobb Early Learning	PK	393	8.4	1951	33		65,127	512
TOTALS		104,849 *	3,034.8		7,399	94	18,054,109	124,586

* Total active enrollment does not include online virtual classrooms.

- (a) Occupied year represents the year during which the school was initially opened and utilized for instructional purposes, but does not reflect the most recent year of subsequent additions, improvements, or renovations, if any.
- (b) With the opening of Smyrna Elementary for school year 2013-14, Brown Elementary closed at the end of 2012-13. During fiscal year ended 2015, Brown facilities were used to house Teasley primary grades during construction of new classrooms at Teasley Elementary.
- (c) Operated by unaffiliated non-profit entities. Enrollment reports by Cobb County District; buildings do not belong to the district.

Source: District Records

Glossary

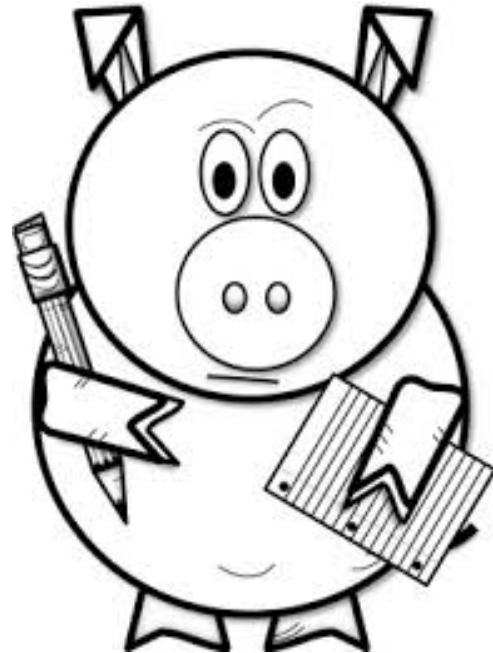

This glossary contains definitions of selected terms used in this document and additional terms and interpretative data, including abbreviations and acronyms, as necessary for common understandings concerning financial accounting procedures of the Cobb County School District. Several terms, which are not primarily financial accounting terms, have been included because of their significance in the budgeting process. The glossary is arranged alphabetically with appropriate cross-referencing where necessary.

ACCOUNTING SYSTEM

The recording and reporting of activities and events affecting the money of an administrative unit and its programs. Specifically, it describes: (1) what accounting records are to be maintained, how they will be maintained, and the procedures, methods, and forms to be used; (2) data recording, classifying, and summarizing activities or events; (3) analyzing and interpreting recorded data; and (4) preparing and initiating reports and statements which reflect conditions as of a given date, the results of operations for a specific period, and the evaluation of status and results of operation in terms of established objectives.

ACCRUE

To record revenues when earned, or when levies are made, and to record expenditures as soon as they result in liabilities, regardless of when the revenue is actually received or the payment is actually made. Sometimes, the term is used in a restricted sense to denote the recording of revenues earned but not yet due, such as accrued interest on investments and the recording of expenditures which result in liabilities that are payable in another accounting period, such as accrued interest on bonds. See also **ACCRUAL BASIS**.

ACCRUAL BASIS ACCOUNTING

The basis of accounting under which revenues are recorded when levies are made and expenditures are recorded as soon as they result in liabilities, regardless of when the revenue is actually received or the payment is actually made. See also **REVENUE** and **EXPENDITURES**.

ACT

American College Testing. One of the American college entrance examinations.

ADA

American with Disabilities Act.

ADMINISTRATION

Activities that have as their purpose the general regulation, direction, and control of the affairs of the local education agency.

AD VALOREM TAXES

Taxes levied on the assessed valuation (less exemptions) of real and personal property, including automobiles. See also **TAX DIGEST** and **ASSESSED VALUATION**.

AGENCY FUND

A fund normally used to account for assets held by a government as an agent for individuals, private organizations or other governments and/or other funds.

ALLOTMENT, TEACHER

The teachers are allotted to the schools on the basis of active enrollment. The formulae used for allocations meet the provisions of the State Board of Education and accrediting standards.

AP

Advanced Placement.

APPROPRIATION

An authorization granted by a legislative body to make expenditures and to incur obligations for specific purposes. Note: An appropriation is usually limited in amount and as to the time when it may be expended.

APPROPRIATION UNIT

A budgetary unit set up to record specific authorizations to spend. The account is credited with original, and any supplemental, appropriations and is charged with expenditures and encumbrances.

AMERICAN RESCUE PLAN ACT of 2021 (ARPA)

Sign into the law on March 11, 2021, the ARPA provides \$350 billion in additional relief funding for state and local governments, for COVID-19 expenditures or negative economic impacts of COVID-19.

AMERICAN RECOVERY AND REINVESTMENT ACT (ARRA)

A federal Act approved by the House of Representatives and Senate on February 13, 2009 to help the nation's economic recovery, create and save jobs, and provided services to people affected by the recession.

ARP ACT

The American Rescue Plan (ARP) Act was signed into law by President Joe Biden on March 11, 2021, to speed up the United States recovery from the economic and health effects of the COVID-19 pandemic and the ongoing recession.

ASBO

Association of School Business Officials International.

ASSESSED VALUATION

A valuation set upon real estate or other property by a government as a basis for levying taxes. Forty percent of full-assessed value is used as the tax basis in Georgia.

AVERAGE DAILY ATTENDANCE, ADA

In a given school year, the average daily attendance for a given school is the aggregate days attendance of the school divided by the number of days school was actually in session. Only the pupils were under the guidance and direction of teachers in the teaching process should be considered as days in session.

AVID

Advancement via Individual Determination

AYP

Adequate Yearly Progress

BALANCE SHEET

A financial statement disclosing the assets, liabilities and equity of an entity at a specified date in conformity with GAAP.

BALANCED BUDGET

A balanced budget is a financial plan in which projected income and other revenues, combined with unrestricted fund balance, equals, or exceeds, the amount proposed to be spent.

BOARD OF EDUCATION, DISTRICT

The elected or appointed body which has been created according to State law and vested with responsibilities for educational activities in a given geographical area. These bodies are sometimes called school boards, governing boards, boards of directors, school committees, school trustees, etc. This definition relates to the general term and covers State boards, intermediate administrative unit boards, and local basic administrative unit boards.

BOND

A written promise, generally under seal, to pay a specified sum of money, called the face value, at a fixed time in the future, called the date of maturity, and carrying interest at a fixed rate, usually payable periodically. The difference between a note and a bond is that the latter usually runs for a longer period of time and requires greater legal formality.

BOND PROPERTY DIGEST

Property digest that the taxes collected for paying off the bond debt.

BONDED DEBT

The part of the School District debt that is covered by outstanding bonds of the district. Sometimes this is called "Funded Debt."

BONDS PAYABLE

The face value of bonds issued and unpaid.

BUDGET

A plan of financial operation embodying an estimate of proposed expenditures for a given period or purpose and the proposed means of financing them. The budget usually consists of three parts. The first part contains a message from the budget-making authority together with a summary of the proposed expenditures and the means of financing them. The second part is composed of drafts of the appropriation, revenue, and borrowing measures necessary to put the budget into effect. The third part consists of schedules supporting the summary. These schedules show in detail the proposed expenditures and means of financing them together with information as to past years' actual revenues and expenditures and other data used in making the estimates.

BUDGET ADJUSTMENTS

An administrative procedure used to revise a budgeted amount after the Annual Budget has been adopted by the Board of Education and approved by the State Board of Education.

BUDGET CALENDAR

The schedule of key dates used in the preparation and adoption of the Annual Budget.

BUDGET CONTROL

The control or management of the business affairs of the school district in accordance with an approved budget with a responsibility to keep expenditures within the authorized amounts.

BUDGET DOCUMENT

The instrument used as a comprehensive financial plan of operations of the Board of Education.

BUILDINGS

A fixed asset account that reflects the acquisition value of permanent structures used to house persons and property owned by the local education agency. If buildings are purchased or constructed, this account includes the purchase or contract price of all permanent buildings and fixtures attached to, and forming a permanent part of such buildings. If buildings are acquired by gift, the account reflects their appraised value at time of acquisition.

CAFR

A Comprehensive Annual Financial Report (CAFR) is a set of U.S. government financial statements comprising the financial report of a state, municipal or other governmental entity that complies with the accounting requirements promulgated by the Governmental Accounting Standards Board (GASB).

CAPITAL BUDGET

A plan of proposed capital outlay with the accompanying finance method for the current fiscal period, which is usually a part of the current year budget. If a Capital Program exists it will consist of the first capital program year. A CAPITAL PROGRAM may also be referred to as a Capital Budget.

CAPITAL OUTLAYS

Expenditures that result in the acquisition of, or addition to, land, buildings, machinery, furniture, and other equipment which the School District intends to hold or continue in use over a long period of time.

CAPITAL PROGRAM

A plan for capital expenditures to be incurred each year over a fixed period of years to meet capital needs arising from the long term work program or otherwise. It sets forth each project or other contemplated expenditure in which the local education agency is to have a part and specifies the full resources estimated to be available to finance the projected expenditures.

CARES ACT

The Coronavirus Aid, Relief, and Economic Security (CARE) Act (2020) was passed by Congress on March 27, 2020 and signed into law on March 27, 2020. The Act implemented a variety of programs to address issues related to the onset of the COVID-19 pandemic.

CASH BASIS ACCOUNTING

A basis of accounting in which transactions are recorded when cash is either received or expended.

CBST

Community-Based Skills Training (CBST). An instructional model used in the Transition Academies which uses community settings as an extension of the classroom.

CCRPI

College and Career Ready Performance Index.

CCSD

Cobb County School District.

CERTIFIED TAX DIGEST

An annual property tax digest certified by the tax receiver or tax commissioner of a county to the Department of Revenue and approved by the State Revenue Commissioner.

CITA

Cobb Innovation & Technology Academy. A Cobb County School District magnet program and facility opened in 2020. CITA offers 15 different career pathways through three “pillars”: Emerging Technologies, Healthcare and Community Services, and Maker Industries.

CLASSIFICATION, FUNCTION

As applied to expenditures, this term has reference to an activity or service aimed at accomplishing a certain purpose or end; for example, Instruction, School Administration, Plant Maintenance and Operation.

CLASSIFICATION, OBJECT

As applied to expenditures, this term has reference to an article or service received; for example, payroll costs, purchased and contracted services, materials, and supplies.

CODING

A system of numbering, or otherwise designating, accounts, entries, invoices, vouchers, etc., in such a manner that the symbol used reveals quickly certain required information.

COLLECTION RATE

A collection rate of 99% is used to approximate the revenue to be collected from ad valorem taxes. This rate accounts for uncollectible taxes and tax releases made by County tax assessors.

COMMITTEE OF 100

An organization of certified employees representing faculties of each school and administrative groups. The committee meets periodically with the Superintendent and Cabinet to address issues and receives information concerning all operations of the School District. Three meetings are scheduled each year.

COVID-19

Novel Coronavirus Disease 2019.

CLASSIFIED COMMITTEE

An organization of classified employees representing classified employees at each school and central office division. The committee meets periodically with the Superintendent and Cabinet to address issues and receives information concerning all operations of the School District. Three meetings are scheduled each year.

CONTRACT SERVICES

Labor, material and other costs for services rendered by personnel who are not on the payroll of the local education agency.

COST PER STUDENT

Financial data (either budget or expenditures) for a given period of time divided by a pupil unit of measure (average daily membership, average daily attendance, etc.).

CRCT

Criterion Reference Competency Test.

CRSSA ACT

The Coronavirus Response and Relief Supplemental Appropriation (CRRSA) Act signed into law by President Donald Trump on December 27, 2020, provides an additional \$54.3 billion for an ESSER II fund. This Federal fund to K-12 schools following the same distribution as the CARES Act.

CTAE

Career, Technology, and Agricultural Education.

CTLS

Cobb Teaching and Learning System.

DEBT

An obligation resulting from the borrowing of money or from the purchase of goods and services. Debts of local education agencies include bonds, warrants and notes, etc.

DEBT LIMIT

The maximum amount of gross or net debt which is legally permitted.

DEBT SERVICE FUND

A fund established to account for the accumulation of resources for, and the payment of, long-term debt principal and interest.

DELINQUENT TAXES

Taxes that remain unpaid on or after the date on which a penalty for non-payment is attached.

DEVEREUX

Devereux is a program uniquely focused on children, teens, and young adults with special medical, psychological, social, emotional needs. Within Cobb County School District, students at Devereux Ackerman Academy receive educational support and services for their growth.

DISBURSEMENTS

Payments for goods and services.

DONATIONS (PRIVATE SOURCES)

Money received from a philanthropic foundation, private individuals, or private organizations for which no repayment or special service to the contractor is expected. Separate accounts may be maintained.

EIP

Early Intervention Program is a Georgia State funded program for Kindergarten through fifth grade students. It is designed to serve students who are at risk of not reaching or maintaining academic grade level.

ELA

English/ Language Arts.

ELEMENTARY SCHOOL

A school classified as elementary by state and local statutes or practice and composed of kindergarten through grade five.

EMPLOYEE BENEFITS (FRINGE BENEFITS)

Amounts paid by the school system on behalf of employees; these amounts are not included in the gross salary. Such payments are, in a sense, overhead payments. They are fringe benefit payments, and while not paid directly to employees, are part of the cost of salaries and benefits. Examples are: (a) group health or life insurance, (b) contribution to employee retirement, (c) Social Security/Medicare, and (d) Worker's Compensation.

ENCUMBRANCE ACCOUNTING

A system or procedure which involves giving recognition in the accounting budgetary expenditure control records for the issuance of purchase orders, statements, or other commitments chargeable to an appropriation in advance of any liability or payment.

ENCUMBRANCES

Purchase orders, contracts, and/or other commitments which are chargeable to an appropriation and for which a part of the appropriation is reserved. They cease to be encumbrances when paid, as in accounts payable, or when actual liability is established or when canceled.

EQUIPMENT

Those moveable items used for school operations that are of a non-expendable and mechanical nature and perform a specific operation. Typewriters, projectors, computers, lathes, machinery, and vehicles, etc., are classified as equipment. (Heating and air conditioning systems, lighting fixtures and similar items permanently fixed to or within a building are considered as part of the building.)

ESOL

English for Speakers of Other Languages. It is the State-funded language instruction educational program for eligible English learners (ELs) in grades K-12 in Georgia public schools.

ESSER FUND

Under the **Elementary and Secondary School Emergency Relief Fund** (ESSER Fund), The US Department of Education awards grants to State educational agencies for the purpose of providing local educational agencies (LEAs) with emergency relief funds to address the impact that COVID-19 has had. The Spending under all three rounds of ESSER funding – through the CARES Act in May 2020, the Coronavirus Response and Relief Supplemental Appropriations Act (CRRSA) in January 2021, and the American Rescue Plan (ARP) in March 2021.

ESTIMATED REVENUE

When the accounts are kept on an accrual basis, this term designates the amount of revenue estimated to accrue during a given period regardless of whether or not it is all to be collected during the period.

EVP

Elementary Virtual Program. Cobb County School District is offering students (PK-5th grade) the option to enter a lottery for seats for full-time online learning. The students will receive all instruction virtually from a certified EVP teacher starting in January 2022.

EXPENDITURES

Decreases in net financial resources. Expenditures include current operating expenses requiring the present or future use of net current assets, debt service and capital outlays, and intergovernmental grants, entitlements and shared revenues.

EXPENSES

Outflows or other using up of assets or incurrence of liabilities (or a combination of both) from delivering or producing goods, rendering services or carrying out other activities that constitute the entity's ongoing major or central operations.

FEDERAL REVENUE

Revenue provided by the federal government. Expenditures made with this revenue are identifiable as federally supported expenditures.

FISCAL PERIOD

Any period at the end of which a local education agency determines its financial position and the results of its operations. The period may be a month, a quarter, or a year, depending upon the scope of operations and requirements for managerial control and reporting.

FISCAL YEAR (FY)

A twelve-month period of time to which the annual budget applies, and at the end of which a local education agency determines its financial position and the results of its operations.

FIXED ASSETS

Land, buildings, machinery, furniture, and other equipment which the School District intends to hold or continue in use over a long period of time. "Fixed" denotes probability or intent to continue use or possession and does not indicate immobility of an asset.

FNS

Food and Nutrition Services.

FORECAST

A projection made for the development of next fiscal year's budget. The projection is based primarily on the annualized cost of providing the same level of services as in the current year.

FRINGE BENEFITS

Total employers share of FICA Taxes, hospitalization, dental, disability, worker's compensation, unemployment, and retirement contributions made on behalf of employees.

FTE (FULL-TIME EQUIVALENCE-EMPLOYEE)

The amount of employed time required in a part-time position expressed in proportion to that required in a full-time position, with 1.000 representing one full-time position. It is derived by dividing the amount of employed time in the part time position by the amount of employed time required in a corresponding full-time position.

FTE (FULL-TIME EQUIVALENCY - STATE FUNDING)

Local school systems in Georgia must report enrollment two times during the school year for funding purposes. This reporting reflects the school day being divided into six parts (periods). The student is counted six times, according to which programs he or she participates in during the day. Students may not be counted for the portion of the day that they are in the following programs or under the following conditions:

1. Study Hall
2. Non-credit courses
3. Driver's education
4. Enrichment courses as defined by QBE or the State Board (generally one that does not devote a major portion of time to the competencies adopted by the State Board)
5. Courses that require complete participation in an extracurricular activity
6. Serving as a student assistant, unless this activity is an approved career or vocational education work program
7. Individual study courses that have no outline of course objectives available
8. Other courses designated by the State Board
9. The student is not enrolled in a program or not attending regularly
10. A resident student paying tuition or fees in excess of the local cost per student
11. A non-resident student paying tuition or fees in excess of the local cost per student
12. A student who has not attended within 10 days of the count

Each student is counted for each one-sixth of the school day for the eligible program in which he or she is enrolled. The resulting total, when divided by six, is known as the full-time equivalent (FTE) program count. An average of the counts reported at two different times during the year are used in the funding formula. See also **QBE**.

FUNCTION

An accounting term relating to both the budget and the financial report. A "function" is a grouping of activities being performed for which salaries and other types of direct costs are expended and accounted. Functions and subfunctions consist of activities that have somewhat the same general operational objectives. Furthermore, categories of activities comprising each of these divisions and subdivisions are grouped according to the principle that the activities should be combinable, comparable, relatable and mutually exclusive. Both the budget and the financial reports group activities within "functions".

FUND

A fiscal and accounting entity which is comprised of a self-balancing set of accounts which reflect all assets, liabilities, equity, revenue, and expenditures (or expenses) necessary to disclose financial position and the results of operations. Funds are established as individual entities in order to segregate financial records for purposes of legal compliance, different natures of the activities performed, measurement of different objectives, and to facilitate management control.

FUND BALANCE

The excess of assets of a fund over its liabilities and reserves. During the fiscal year prior to closing, it represents the excess of the fund's assets and estimated revenues for the period over its liabilities, reserves and appropriations for the period.

FUND BALANCE, UNRESERVED

The portion of Fund Balance that is not reserved for encumbrances, debt service or similar items.

FUND, CAPITAL PROJECTS

Used to account for all resources used for acquiring capital sites, buildings, and equipment as specified by the related bond issue. Capital project funds are designated to account for acquisition or construction of capital outlay assets that are not acquired directly by the general fund, special revenue funds, or enterprise funds. Capital project funds have been developed to account for the proceeds of a specific bond issue and revenue from other possible sources which is designated for capital outlay, i.e., for land, buildings, and equipment.

FUND, DEBT SERVICE

Used to finance and account for payment of principal and interest on all long-term general obligation debts. Debt service funds are used to accumulate resources over the outstanding life of the bond issue in an amount equal to the maturity value. Cash of the debt service may be invested in income-producing securities that are converted back into cash at the maturity date for use in retiring bonds.

FUND, ENTERPRISE

Used to finance and account for the acquisition, operations, and maintenance of School District facilities and services which are entirely or predominantly self-supportive by user charges. Budgetary accounts and formal budgetary accounting are recommended for Enterprise Funds. The accounting consists primarily of proper recording of receipts and disbursements.

FUND, GENERAL

The fund used to finance the ordinary operations of the local education agency. It is available for a legally authorized purpose and consists of money not specifically designated for some other particular purpose.

FUND, INTERNAL SERVICE

A fund established to finance and account for services and commodities furnished by a designated department or agency to other departments and agencies within a single governmental unit. Amounts expended by the fund are restored thereto either from operating earnings or by transfer from other funds so that the original fund capital is kept intact.

FUND, SPECIAL REVENUE

A fund used to account for the proceeds of specific revenue sources (other than special assessments, expendable trusts, or for major capital projects) that are legally restricted to expenditures for specific purposes.

FUND, TRUST AND AGENCY - FIDUCIARY

A fund used to account for money and property held in trust by a school system for individuals, government entities, or non-public organizations. A Trust Fund is usually in existence over a longer period of time than an Agency Fund. Primarily, Agency Funds function as a clearing mechanism for cash resources collected by the District held for a short period, and then disbursed to authorized recipients.

GAAP

General Accepted Accounting Principles.

GASB

The Governmental Accounting Standards Board (GASB) is the source of generally accepted accounting principles (GAAP) used by State and Local governments in the United States. As with most of the entities

involved in creating GAAP in the United States, it is a private, non-governmental organization.

GED

General Education Development.

GENERAL FUND

The fund used to account for all financial resources except those required to be accounted for in another fund.

GENERAL LONG-TERM DEBT

Liability for general obligations bonds. The general long-term debt of a state or local government is secured by the general credit and revenue-raising powers of the government rather than by the assets acquired or specific fund resources.

GFOA

Government Finance Officers Association.

GHSGT

Georgia High School Graduation Test.

GOVERNMENTAL FUNDS

Those funds through which most government functions are financed. The category includes general fund, special revenue funds, capital projects fund, debt service fund, etc.

GRANT

Contributions of either money or material goods given by a contributing unit (public or private) to another receiving unit and for which the contributing unit expects no repayment. Grants may be for a specific or general purpose.

H.A.V.E.N.

The abbreviation stands for Hope, Achievement, Victory, Encouragement, Nobility. H.A.V.E.N Academy in Cobb County School District provides comprehensive special education and support for students with severe emotional behavior disorders and autism.

HIGH SCHOOL

A school classified as high school by state and local statutes or practices and composed of grades nine through twelve.

HOMESTEAD EXEMPTION

A Tax relief measure whereby state law permits local governments to exempt a fixed dollar amount of appraised value of qualifying residential property.

HOUSE BILL 251

HB 251 – Public School Choice. A law signed by Georgia Governor Perdue in 2009 that allows parents of K-12 public school students in Georgia the opportunity to enroll their child in designated schools within the local school district in which they now reside.

HVAC

Heating, ventilation and air conditioning.

IB

International Baccalaureate.

IDEA

Individuals with Disabilities Education Act.

IEL

Intensive English Language (IEL) program is to provide short-term intensive English support for newly arrived students, who have little to no proficiency in English.

IEP

Individualized Education Plan (IEP) is a plan or program developed to ensure that a child who has a disability identified under the law and is attending an elementary or secondary educational institution receives specialized instruction and related services.

INSTRUCTION

Direct interaction between students and classroom teachers, paraprofessionals and/or related staff involving teaching students in a teaching/learning environment in a systematic program designed to assist students in acquiring competency in knowledge, skills, and understanding.

INSTRUCTIONAL MATERIALS - SUPPLIES

An object of expenditure related to amounts paid for the acquisition of devices, content materials, methods or experiences used for teaching and learning purposes. These include printed and non-printed sensory materials.

INTER-FUND TRANSFERS

Amounts transferred from one fund to another fund except loans, interfund services provided and used, and reimbursements.

INVOICE

An itemized statement of merchandise shipped or sent to a purchaser, consignee, etc., with the quantity, value or prices, and charges annexed.

IT

Information Technology

KINDERGARTEN

A group or class that is organized to provide educational experience for children for the year immediately preceding the first grade and conducted during the regular school year.

LAND

A fixed asset account that reflects the acquisition value of land owned by a school system. If land is purchased, this account includes the purchase costs and other associated improvement costs which are incurred to put the land in condition for its intended use. If land is acquired by gift, the account reflects its appraised value at time of acquisition.

LAPSE

The difference between budgeted revenue and expenses and actual revenue and expenses.

LEA

Local Educational Agency.

LEP

Limited English Proficiency.

LEVY

(Verb) To impose taxes or special assessments. (Noun) The total of taxes or special assessments imposed by a governmental unit.

LIABILITY (INSURANCE)

Expenditures for insurance coverage of the school system, or its officers, against losses resulting from judgments awarded against the system. Also recorded here are any expenditures (not judgments) made in lieu of liability insurance.

LOCAL FAIR SHARE

Each local board of education is required to provide and use local funds in support of the QBE Act. A minimum of the equivalent of 5 mills must be provided. The Local Fair Share is computed by the Georgia Department of Education and identified on the allotment sheet provided to each school system following actions of the Georgia General Assembly. The Local Fair Share equates to five effective mills on the equalized, adjusted tax digest as certified by the Department of Audits and adjusted for exemptions. Local Fair Share is subtracted from the total QBE revenue entitlements.

LOST AND DAMAGED TEXTBOOKS

The cost of replacing textbooks, lost or damaged, so that inventories are maintained at prescribed levels.

LONG-TERM DEBT

Debt with a maturity of more than one year after the date of issuance.

LUA

Local Units of Administration.

M & O

The abbreviation "M&O" stands for "Maintenance and Operations", the term used in state or local taxes levied for this purpose.

MAINTENANCE OF PLANT

Those activities which are concerned with keeping the grounds, buildings, and equipment at their original condition of completeness or efficiency, either through repairs or by replacements of property (anything less than replacement of a total building).

MIDDLE SCHOOL

A school classified as middle by state and local statutes or practices and composed of grades six through eight.

MILL

The rate of taxation based on dollars per thousand of taxable assessed value. A mill is one-tenth of a cent (\$.001).

MILLAGE RATE

The ad valorem tax rate expressed in terms of the levy per thousand dollars of taxable assessed value established by the governing authority each fiscal year.

MODIFIED ACCRUAL BASIS ACCOUNTING

The basis of accounting which recognizes revenue when measurable and available. Measurable means the amount of the transaction can be determined; and available means collectible within the current period or soon enough thereafter to pay liabilities of the current period. The District considers revenues available if they are collected within 60 days after year-end.

MOWR – MOVE ON WHEN READY

Move On When Ready is Georgia’s new dual enrollment program that allows high school students (9th – 12th grade) to earn college credit while working on their high school diploma. The goal of Move On When Ready program is to increase college access and completion, and prepare students to enter the workforce with the skills they need to succeed.

NBCT

National Board Certification for Teachers.

OBJECT

An accounting term used to describe the service or commodity obtained as a result of a specific expenditure or to describe a specific revenue source.

OPERATING BUDGET

The operating budget is typically organized by department, providing details on line items such as supplies, services, travel, utilities, and office equipment. Non-salary and non-fringe benefit accounts.

PAYROLL (COSTS)

All costs covered under the following objects of expenditure: Certified Salaries, Classified Salaries and Employee Benefits.

PER PUPIL (ALLOTMENT)

An allotment to each school for supplies and equipment initially based on the first FTE count of the fiscal year.

PER STUDENT (EXPENDITURE)

An accepted and commonly used norm to compare expenditures between school districts, state spending and national spending.

PERSONNEL, ADMINISTRATIVE

Personnel on the school payroll who are primarily engaged in activities which have as their purpose the general regulation, direction, and control of the affairs of the School District that are system-wide and not confined to one school, subject, or narrow phase of school activity; for example, superintendent of schools.

PERSONNEL, CLERICAL

Personnel occupying positions which have as their major responsibilities the preparing, transferring, transcribing, systematizing, or preserving of written communications and records.

PERSONNEL, INSTRUCTIONAL

Those who render services dealing directly with the instruction of pupils. Included here are: teachers, paraprofessionals.

PERSONNEL, MAINTENANCE

Personnel on the school payroll who are primarily engaged in the repairing and upkeep of grounds, buildings, and equipment.

PROGRAM

The definition of an effort to accomplish a specific objective or objectives consistent with funds or resources available. Budgets and actual revenue and expenditure records may be maintained per program.

PROGRAM BUDGET

A budget wherein expenditures are based primarily on programs of work and secondarily on character and object. A program budget is a transitional type of budget between the traditional character and object budget on the one hand, and the performance budget, on the other.

PROGRAM WEIGHTS

Since different programs vary in their cost to operate, each of the nineteen (19) QBE programs is assigned a different program weight. These weights reflect the cost of teachers, paraprofessionals, and other instructional personnel; instructional materials; facility maintenance and operation (M & O) costs; media center personnel and materials costs; school and central office administration costs and staff development. The Grade 9-12 program is defined as the "Base" program for the purpose of determining relative program costs. The cost of Base Grade 9-12 program is given a weight of "1.0000". The other eighteen (18) programs are assigned weights that reflect their cost relative to this base grades program. See also **QBE**.

PROPERTY INSURANCE

Expenditures for all forms of insurance covering the loss of, or damage to, property of the local education agency from fire, theft, storm, or any other cause. Also recorded here are costs for appraisals of property for insurance purposes.

PROPRIETARY FUND

A fund used to account for ongoing organizations and activities which are similar to those found in the private sector.

PTA

Parent Teacher Association.

PUPIL TRANSPORTATION SERVICES

Consists of those activities involved with the conveyance of pupils to and from school activities, as provided by state law. Includes trips between home and school or trips to school activities. This service area is applicable to both schools and school system.

PURCHASE ORDER

Document that authorizes the delivery of specified merchandise or the rendering of certain services and the making of a charge for them.

PURCHASED SERVICES

Personal services rendered by personnel who are not on the payroll of the school system and other services that may be purchased by the school system.

QBE (QUALITY BASIC EDUCATION) - ALLOTMENTS

Funds are allotted by the state on the basis of "Weighted FTE" (FTE: Full Time Equivalent students) to the local school system. The following are nineteen programs of allotment under QBE:

<u>Program Name</u>	<u>Program Name</u>
Kindergarten	Special Education Category I
Kindergarten EIP	Special Education Category II
Primary Grades (1-3)	Special Education Category III
Primary Grades EIP	Special Education Category IV
Upper Elementary Grades (4-5)	Special Education Category V
Upper Elementary EIP	Gifted Student Category VI
Middle Grade (6-8)	Remedial Education
Middle School (6-8)	Alternative Program
High School General Education (9-12)	ESOL Program
Vocational Labs (9-12)	

A program is a plan of activities and procedures designed to accomplish a predetermined objective or set of objectives.

Because the QBE formula is based on FTE counts that are taken primarily in the previous school year, there will be a need to adjust the total allotment mid-year as more recent counts become available. If the more recent counts result in an increase in funds needed, the State Board will request the additional funds from the General assembly.

QBE – AUSTERITY

The QBE formula reduction to decrease the allotment due to the difficult financial challenges to State revenues and the program expenditure cut is necessary.

QBE – MID YEAR ADJUSTMENT

The adjustment of QBE allotment that reflect the more recent FTE count of a school system in the current school year, to increase or decrease the QBE earning that based on FTE count taken in the previous year.

REIMBURSEMENT

Cash or other assets received as a repayment of the cost of work or services performed, or of other expenditures made for or on behalf of another governmental unit or department, or for an individual, firm, or corporation.

RENTALS

Expenditures for the lease or rental of land, buildings, and equipment for the temporary or long-range use of the local education agency.

RESERVE

An account used to indicate that a portion of fund balance is restricted for a specific purpose.

RESERVE FOR ENCUMBRANCES

A reserve representing the designation of a portion of a fund balance to provide for unliquidated encumbrances. Separate accounts may be maintained for current and prior-year encumbrances.

REVENUE

Additions to the assets of a fund during a fiscal period that are available to finance the fund's expenditures during the fiscal period.

REVISED BUDGET

An increase or decrease to the initial budget (original amount as adopted by the governing body) amount.

RTI2

Response to Instruction & Intervention.

SACS

Southern Association of Colleges and Schools, is one of the six regional accreditation organization recognized by the United States Department of Education and the Council for Higher Education Accreditation.

SALARIES

Total expenditures for hourly, daily, and monthly salaries including overtime pay and sick pay.

SCHOOL

A division of the school system consisting of a group of pupils composed of one or more teachers to give instruction of a defined type, and housed in a school plant of one or more buildings.

SCHOOL PLANT

The site, buildings, and equipment constituting the physical facilities used by a single school or by two or more schools sharing the use of common facilities.

SCHOOL SITE

The land and all improvements to the site, other than structures, such as grading, drainage, drives, parking areas, walks, plantings, play courts, and play fields.

SEA

State Educational Agency

SERIAL BONDS

A set of bonds issued at the same time but having different maturity dates

SLP

Speech Language Pathologists

SPECIAL EDUCATION

Consists of direct instructional activities designed to deal with the following pupil exceptionalities: Self-contained specific learning disability, speech-language impairment, emotional and behavior disorder, deaf, blind, orthopedic disability, and other health impairment.

SPLOST

Special Local Option Sales Tax - extra one-cent sales tax voted on and approved by citizenry to be used by the School District for capital improvements and debt retirement.

STEM

Science, Technology, Engineering, and Math.

SUPPLIES

Expenditures for material items of an expendable nature that are consumed, worn-out, or deteriorated by use or items that lose their identity through fabrication or incorporation into different or more complex units or substances.

SUPPLY TEACHER

A long-term substitute teacher that works from ten days to twelve weeks.

STRATEGIC WAIVERS SCHOOL SYSTEM (SWSS) PARTNERSHIP CONTRACT

A contract between the State Board of Education and the local Board of Education that provides flexibility in the form of waivers of certain state laws, rules and guidelines in exchange for greater accountability for increased student performance.

TAXES

Compulsory charges levied by a governmental unit for the purpose of financing services performed for the common benefit.

TAX DIGEST

The established formula for the County to determine the net Maintenance and Operations (M & O) property digest for the School District on a calendar year basis which includes total real, personal, motor vehicles, mobile homes, and public utility property, less homestead, various personal, Freeport and agricultural exemptions. The Tax Digest is certified in July of each year and the local board of education sets official millage rate.

TRANSFERS

Amounts transferred between two funds. The offsetting transaction is recorded in the revenue source in the fund to which the transfer is made.

TRAVEL

An object of expenditure associated with carrying staff personnel from place to place and the furnishing of accommodations incidental to travel. Also included are per diem allowances, mileage allowances for use of privately owned vehicles, and other expenditures necessitated by travel.

TRS

Teachers' Retirement System.

TUITION, RECEIVED

Money received from pupils, their parents, governmental agencies, or others for education provided in the schools of the District.

USDA

United States Department of Agriculture.

VOCATIONAL PROGRAM

A school which is separately organized for the primary purpose of offering education and training in one or more semi-skilled, skilled, or technical occupations.

School Board Members

David Chastain, Chairperson

David Banks, Vice Chairperson

David Scamihorn

Jaha Howard

Leroy Tre' Hutchins

Charisse Davis

Brad Wheeler

Chris Ragsdale, Superintendent

COBB COUNTY SCHOOL DISTRICT

MARIETTA, GEORGIA

www.cobbk12.org

